

MODEL	SPECIFICATION		Page
BS(E)/BSM series Box Slide Type	DIP SWITCH RoHS & REACH Compliant / Halogen Free	SP-001	1/11

Order Information

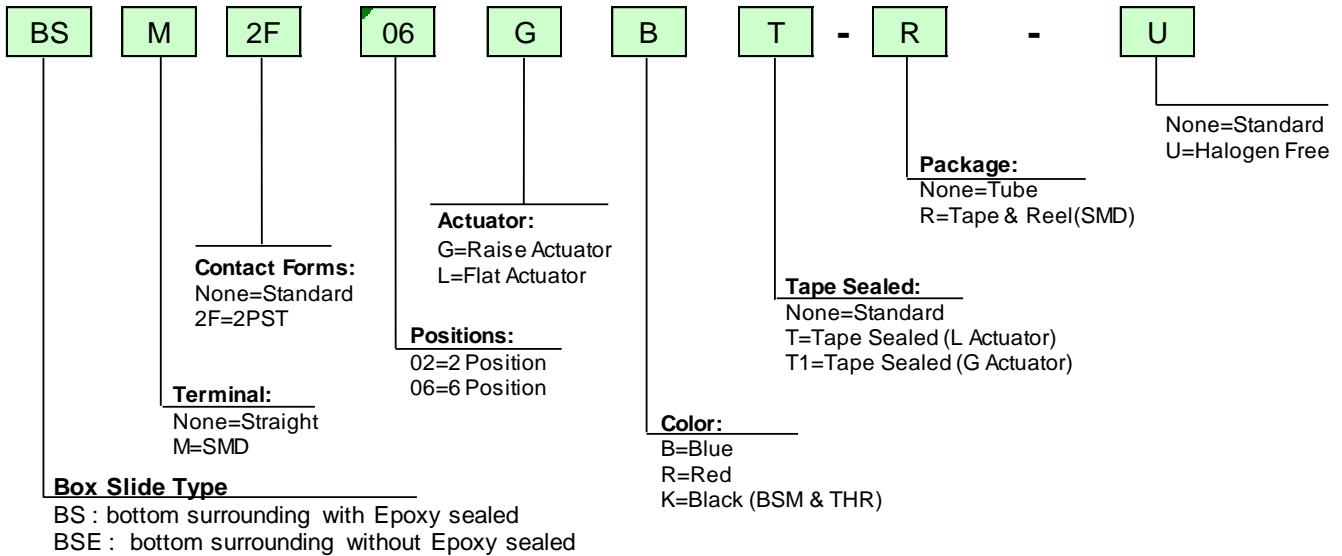

Specifications

◆ Contact Rating	Switching..... 25mA, 24VDC	Non-Switching..... 100mA, 50VDC
◆ Contact Resistance	Initial..... 50mΩ Max	After Reliability Test..... 100mΩ Max
	◆ Insulation Resistance 100MΩ Min. at 500 VDC	
◆ Dielectric Strength 500VAC/ 1 minute	
◆ Operating Force 1,000g Max	
◆ Travel 1.8mm	
◆ Mechanical Life 5,000 cycles (Min.)	
◆ Electrical Life 2,000 cycles/ 25mA, 24VDC	
◆ Operating Temperature	SMD/THR..... -40°C ~ +105°C	THT..... -40°C ~ +85°C
	◆ Storage Temperature -40°C ~ +85°C	

Recommended Soldering Information

- ◆ **Hand Soldering**
Soldering iron of 30W or under at 350°C for 3 sec. max. or at 270°C for 5 sec. max.
- ◆ **Reflow Soldering: (for BSM)**
(1) The peak temperature of the oven for BSM and BS-THR series should be 245°C max. The time above 240°C must be 30 sec. max.
(1) For Vapor Phase Heating (VPH) use, the switch must be tape-sealed.
- ◆ **Wave Soldering**
For lead free wave solder simulation of typical components, the solder bath temperature shall be maintained at (1) BS: 260±5°C for 10 sec. max.
(2) BSE: 260±5°C for 5 sec. max.
- ◆ **Keep all actuators in "OFF" position during soldering and cleaning processes.**

MODEL	SPECIFICATION		Page
BS(E)/BSM series Box Slide Type	DIP SWITCH RoHS & REACH Compliant / Halogen Free	SP-002	2/11

Classification Reflow Profiles

Profile Feature	Pb-Free Assembly
Preheat / Soak	
Temperature Min ($T_{S_{min}}$)	150°C
Temperature Max ($T_{S_{max}}$)	200°C
Time(ts) from ($T_{S_{min}}$ to $T_{S_{max}}$)	60 ~120 seconds
Ramp-up Rate (T_L to T_p)	3°C/second max
Liquidous temperature (T_L)	217°C
Time (t_L) maintained above to T_L	60 ~ 150 seconds
Peak package body temperature (T_p)	For users T_p must not exceed the Classification temp: 245°C (Package Thickness:>2.5mm) Reference Table 4-2 For suppliers T_p must equal or exceed the Classification temp: 245°C (Package Thickness:>2.5mm) Reference Table 4-2
Time (t_p) within 5°C of specified classification Temperature (T_c)	30 seconds
Ramp-Down Rate (T_p to T_L)	6°C/second max
Time 25°C to Peak Temperature	8 minutes max
* Tolerance for peak profile temperature(T_p) is defined as a supplier minimum and a user maximum	

Note 1: All temperatures refer to topside of the package, measured on the package body surface.

Note 2: Time within 5°C of actual peak temperature (t_p) specified for the reflow profiles is a “supplier” minimum and “user” maximum.

Table 4-2 Pb-Free Process - Classification Temperatures (T_c)

Package Thickness	Volume mm ³ <350	Volume mm ³ 350 - 2000	Volume mm ³ >2000
<1.6 mm	260 °C	260 °C	260 °C
1.6 mm - 2.5 mm	260 °C	250 °C	245 °C
>2.5 mm	250 °C	245 °C	245 °C

MODEL	SPECIFICATION DIP SWITCH	Page
BS(E)/BSM series Box Slide Type		SP-003
RoHS & REACH Compliant / Halogen Free		3/11

Recommended Reflow Soldering

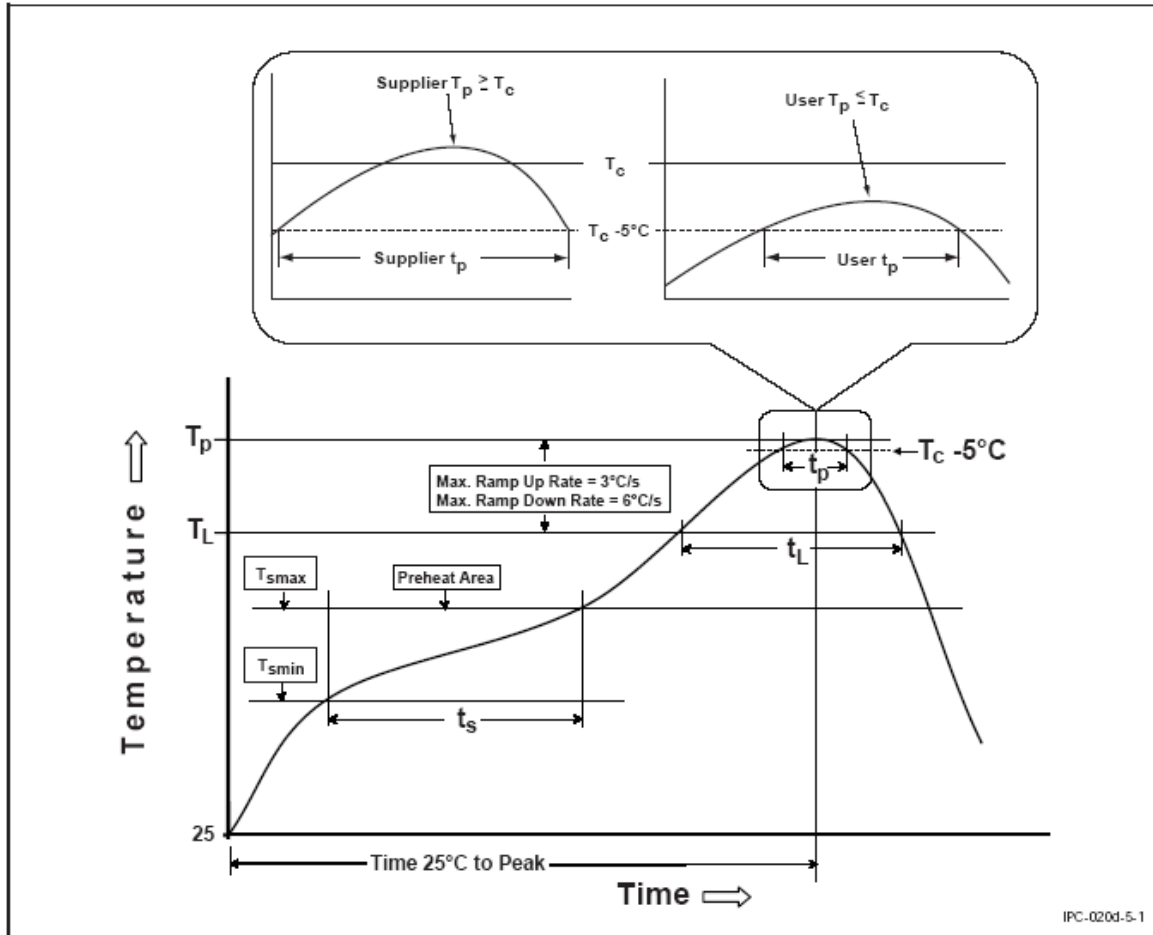

Source: IPC/JEDEC J-STD-020D.1

MODEL	SPECIFICATION	SP-004	Page
BS(E)/BSM series Box Slide Type	DIP SWITCH RoHS & REACH Compliant / Halogen Free		4/11

Recommended Wave Soldering Profiles

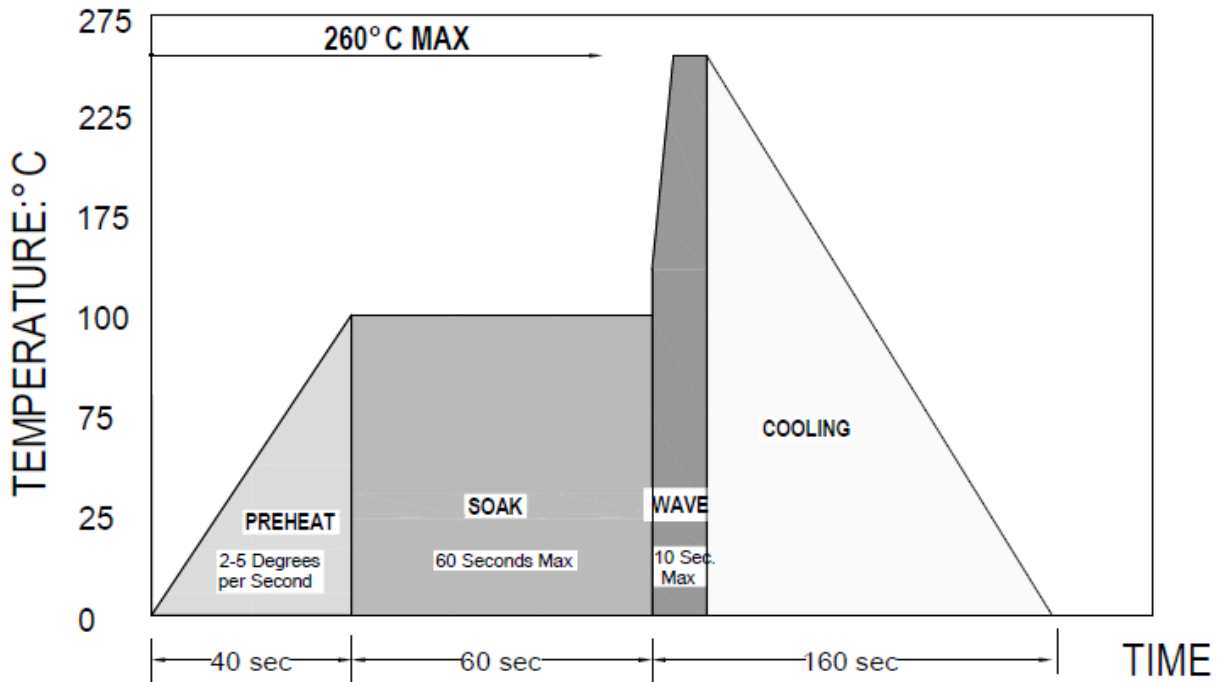

BS type: Maximum dwell time in the solder wave (260°C) shall not exceed 10 seconds.

BSE type: Maximum dwell time in the solder wave (260°C) shall not exceed 5 seconds.

Switch Operation and Taping

- (1) Use tweezers for operation
- (2) Flux cleaning should be done without removing the Tape.
- (3) If the tape is removed, it adheres less than before when it is placed back on, possibly causing flux inflow.
- (4) Do Not Remove Tape sealed before Reflow processing.
- (5) Ultrasonic cleaning not recommended without Tape sealed.

※ All switches must set in OFF position when through Soldering process.

※ Any flux enters the switch may influence contact function.

MODEL	SPECIFICATION	Page
BS(E)/BSM series Box Slide Type	DIP SWITCH RoHS & REACH Compliant / Halogen Free	SP-005 5/11

Materials

<ul style="list-style-type: none"> ◆ Cover ◆ Base ◆ Actuator ◆ Contact ◆ Terminal ◆ Tape 	<p>RoHS&REACH Compliant... Thermoplastic UL 94V-0, Red/ Blue/ Black(BSM) Halogen Free..... Thermoplastic UL 94-HB, Red/ Blue Halogen Free..... Thermoplastic UL 94V-0, Black(BSM)</p> <p>BS/BSE..... Thermoplastic UL 94-HB, Black BSM/BSEM..... Thermoplastic UL 94V-0, Black</p> <p>..... Thermoplastic UL 94-HB, White</p> <p>..... Cooper Alloy, 1u" Gold-Plated over Nickel</p> <p>..... Cooper Alloy, Tin-Plated over Nickel</p> <p>..... Polyimide Film</p>
--	---

BS/BSE

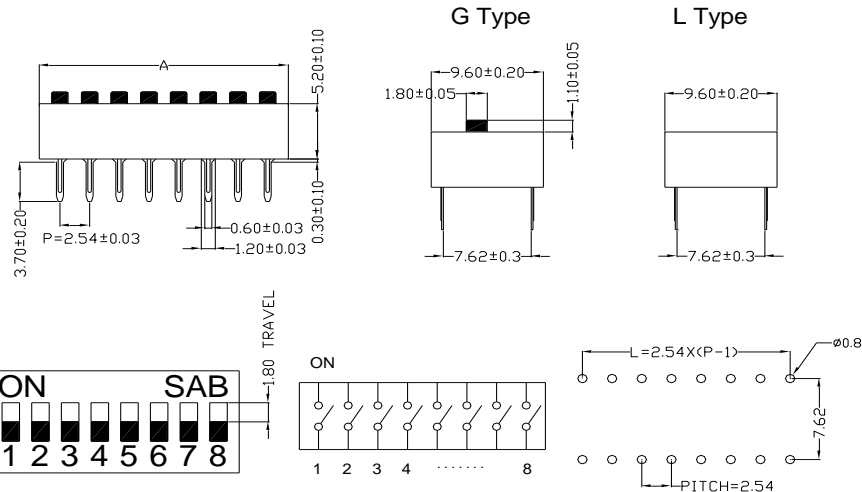
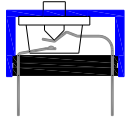
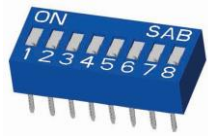

BS2F/BSE2F

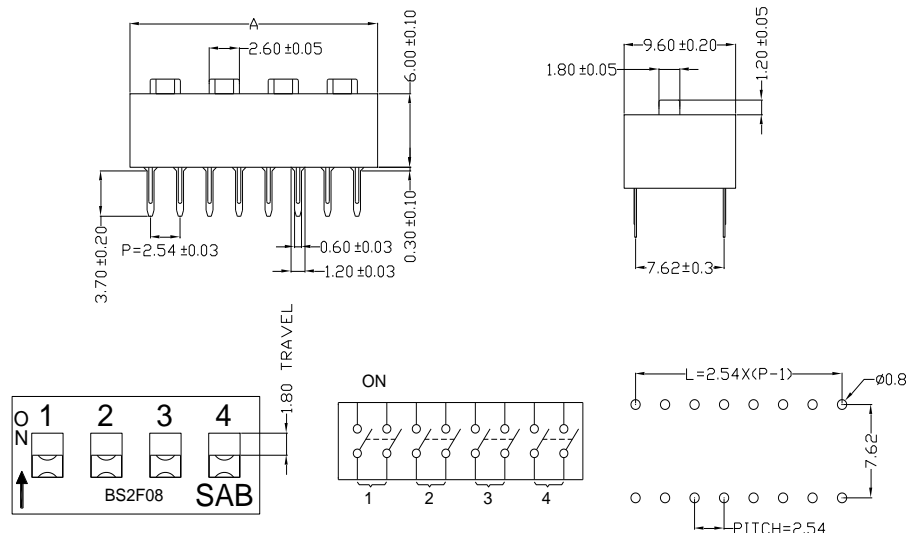
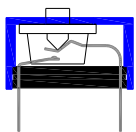
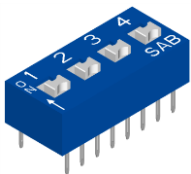

MODEL	SPECIFICATION DIP SWITCH	SP-006	Page
BS(E)/BSM series Box Slide Type			6/11
RoHS & REACH Compliant / Halogen Free			

BSM

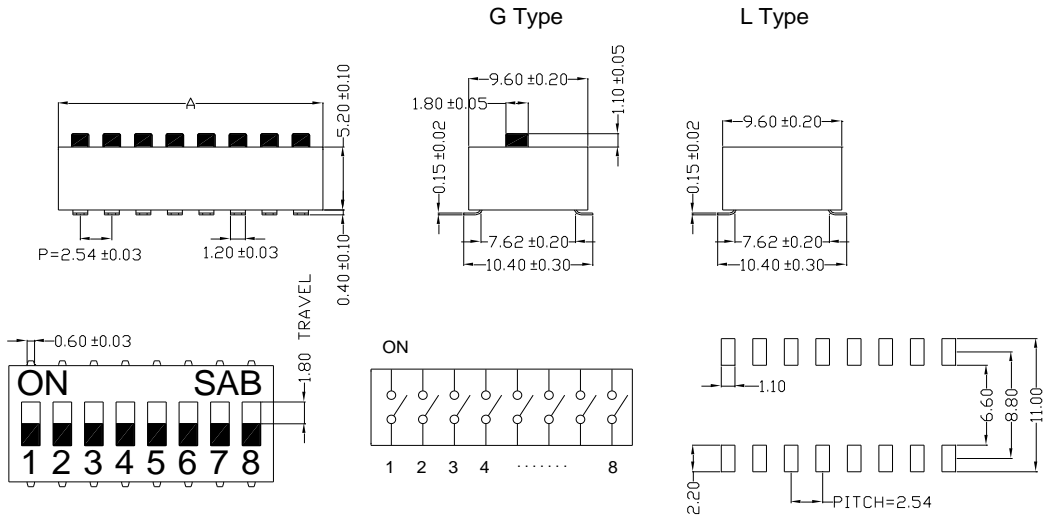
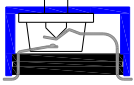
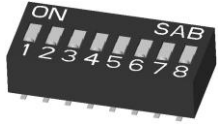

BSM2F

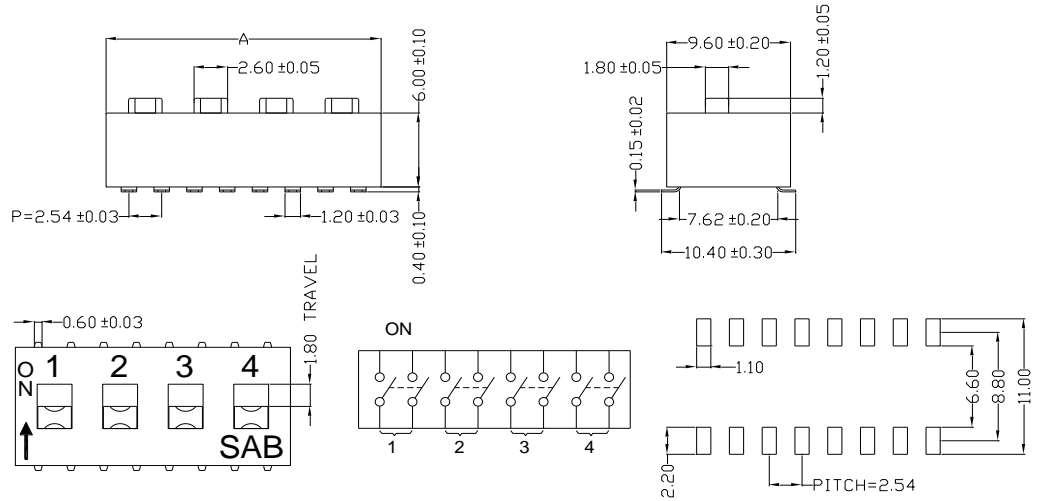
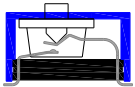
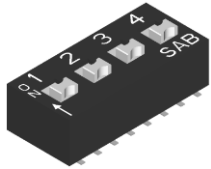

MODEL	SPECIFICATION	SP-007	Page
BS(E)/BSM series Box Slide Type	DIP SWITCH RoHS & REACH Compliant / Halogen Free		7/11

Part Number Table

BS(E) / BS(E)M

No. Pos.	Dim. "A"	Through Hole		SMD		
		BSE Raise Actuator Blue Tube Package	BS Flat Actuator Red Tube Package	BSM Raise Actuator Black Tube Package	BSM Flat Actuator Black Tube Package	BSM Raise Actuator Black Tape & Reel
1	3.54	BSE01GB	BS01LR	BSM01GK	BSM01LK	BSM01GK-R
2	6.08	BSE02GB	BS02LR	BSM02GK	BSM02LK	BSM02GK-R
3	8.62	BSE03GB	BS03LR	BSM03GK	BSM03LK	BSM03GK-R
4	11.16	BSE04GB	BS04LR	BSM04GK	BSM04LK	BSM04GK-R
5	13.70	BSE05GB	BS05LR	BSM05GK	BSM05LK	BSM05GK-R
6	16.24	BSE06GB	BS06LR	BSM06GK	BSM06LK	BSM06GK-R
7	18.78	BSE07GB	BS07LR	BSM07GK	BSM07LK	BSM07GK-R
8	21.32	BSE08GB	BS08LR	BSM08GK	BSM08LK	BSM08GK-R
9	23.86	BSE09GB	BS09LR	BSM09GK	BSM09LK	BSM09GK-R
10	26.40	BSE10GB	BS10LR	BSM10GK	BSM10LK	BSM10GK-R
12	31.48	BSE12GB	BS12LR	BSM12GK	BSM12LK	BSM12GK-R

BS(E)2F/BS(E)M2F

No. Pos.	Dim. "A"	Through Hole		SMD	
		BS2F Raise Actuator Standard Red Tube Package	BS2F Raise Actuator Standard Blue Tube Package	BSEM2F Raise Actuator Standard Black Tube Package	BSM2F Raise Actuator Standard Black Tube Package
1	6.08	BS2F01GR	BS2F01GB	BSM2F01GK	BSM2F01GK
2	11.16	BS2F02GR	BS2F02GB	BSM2F02GK	BSM2F02GK
3	16.24	BS2F03GR	BS2F03GB	BSM2F03GK	BSM2F03GK
4	21.32	BS2F04GR	BS2F04GB	BSM2F04GK	BSM2F04GK
5	26.40	BS2F05GR	BS2F05GB	BSM2F05GK	BSM2F05GK

MODEL	SPECIFICATION DIP SWITCH RoHS & REACH Compliant / Halogen Free	SP-008	Page
BS(E)/BSM series Box Slide Type			8/11

Tube Package

◆ BS(E)/BSM

POLE	1	2	3	4	5	6	7	8	9	10	12
TUBE	148	85	61	47	38	32	28	24	22	20	16
BOX	11840	6800	4880	3760	3040	2560	2240	1920	1760	1600	1280
CTN 1	23680	13600	9760	7520	6080	5120	4480	3840	3520	3200	2560
CTN 2	47360	27200	19520	15040	12160	10240	8960	7680	7040	6400	5120

◆ BS2F/BSM2F

POLE	1	2	3	4	5	6
TUBE	85	47	32	24	20	16
BOX	4760	2632	1792	1344	1120	896
CTN 1	9520	5264	3584	2688	2240	1792
CTN 2	19040	10528	7168	5376	4480	3584

BS(E)/BSM

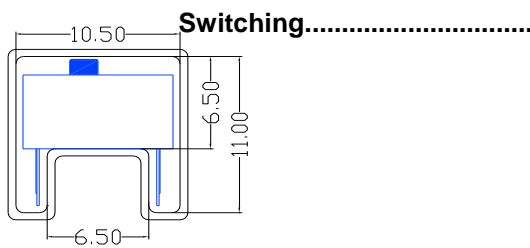

BS(E)2F/BSM2F

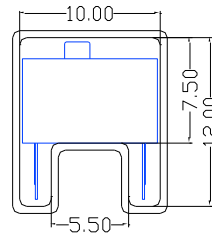

Tape & Reel package

◆ BSM

POLE	02	03	04	05	06	07	08	10	12
Pitch (mm)	12	16	16	16	16	16	16	16	16
Width (mm)	24	24	24	24	24	44	44	44	44
Per Reel	700	500	500	500	500	500	500	500	500

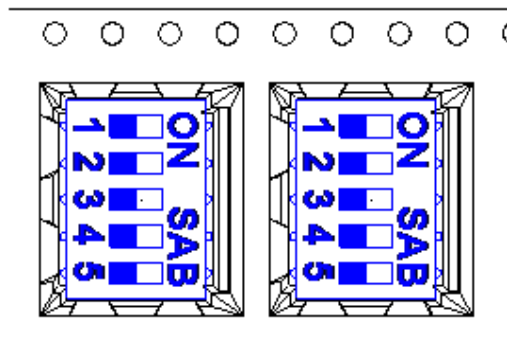

MODEL	SPECIFICATION DIP SWITCH RoHS & REACH Compliant / Halogen Free	SP-009	Page
BS(E)/BSM series Box Slide Type			9/11

Carry Tape Table

P/N	Pitch(mm)	Thickness(mm)	Width(mm)	Sellota[e(mm)	@REEL/BOX	Q'ty/Reel
BSM02	12	0.4	24	21.3	4	700
BSM03	16	0.4	24	21.3		500
BSM04	16	0.4	24	21.3		500
BSM05	16	0.4	24	21.3		500
BSM06	16	0.4	32	25.5	3	500
BSM08	16	0.4	44	37.5	2	500
BSM10	16	0.4	44	37.5		500
BSM12	16	0.4	44	37.5		500

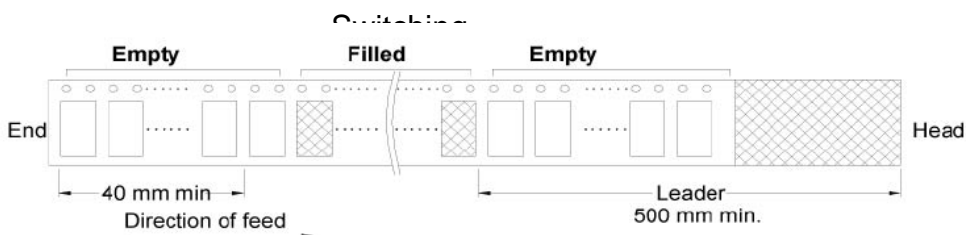

TAPE AND REEL PACKAGING

Meet EIA 481-2D & EIA 481-3

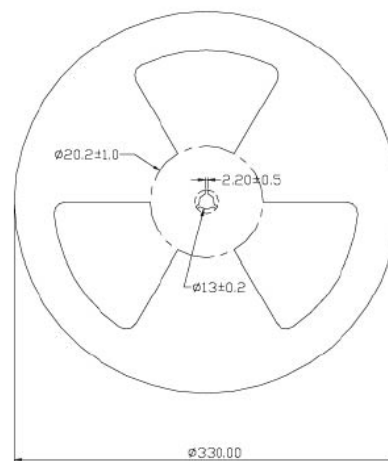
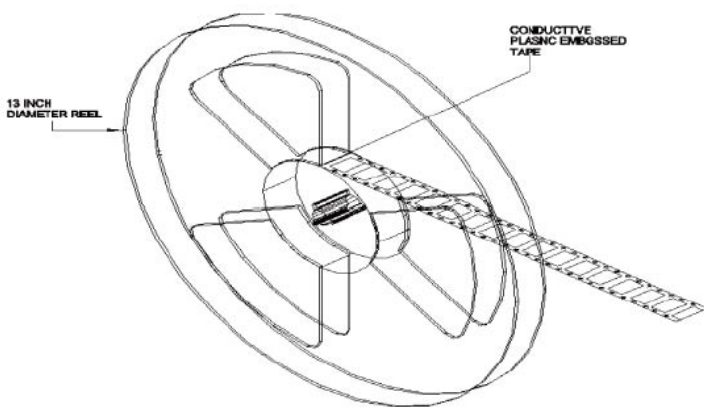

MODEL	SPECIFICATION DIP SWITCH RoHS & REACH Compliant / Halogen Free	SP-010	Page
BS(E)/BSM series Box Slide Type			10/11

24mm

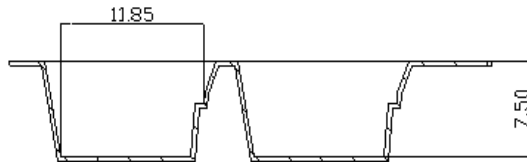
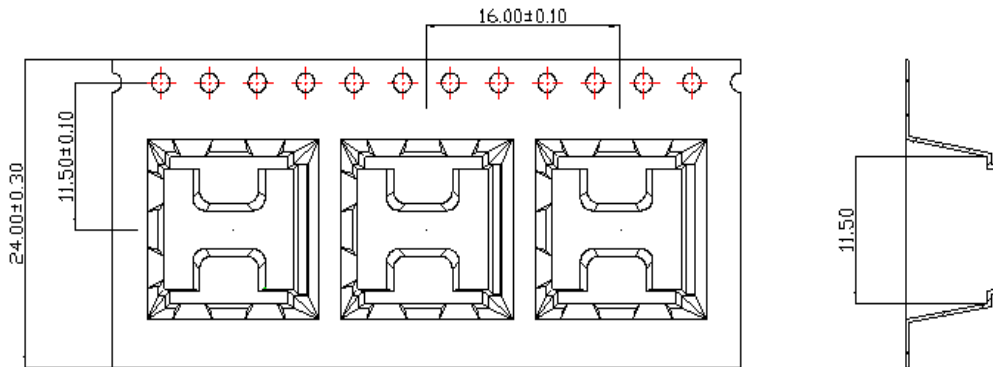

Switching.....

32mm

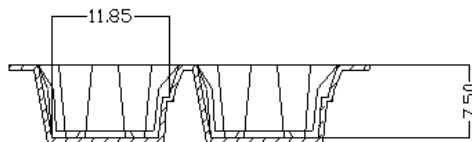
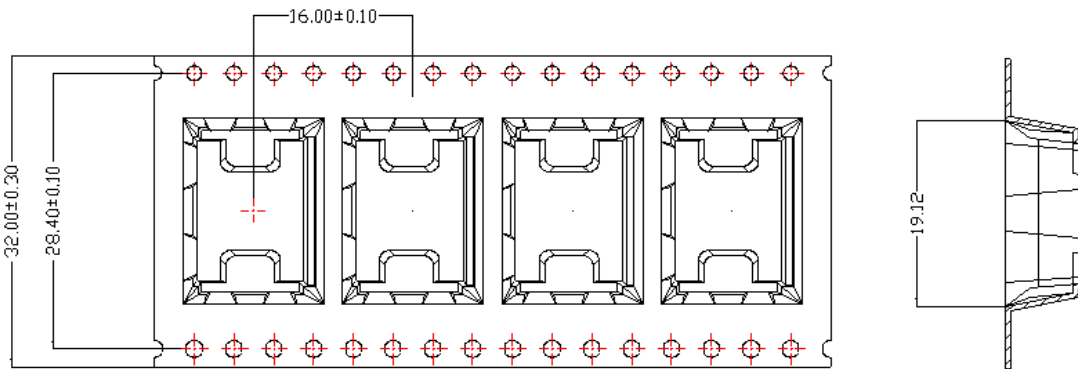

MODEL	SPECIFICATION DIP SWITCH RoHS & REACH Compliant / Halogen Free	SP-011	Page
BS(E)/BSM series Box Slide Type			11/11

44mm

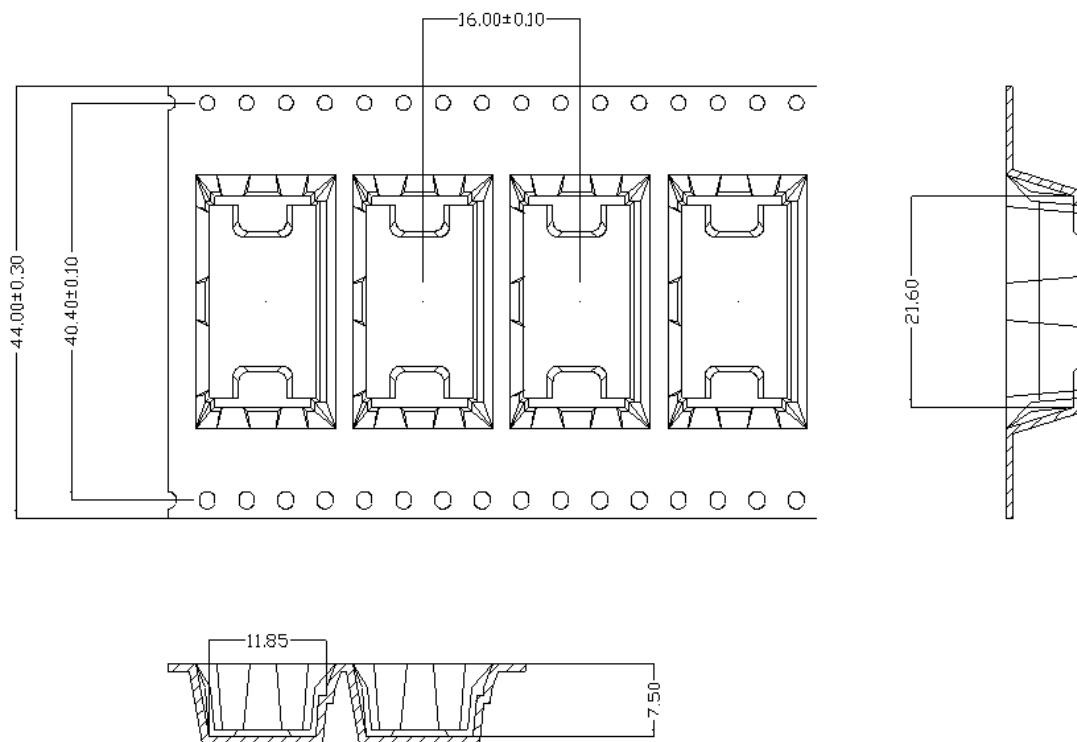

Box Dimension

- ◆ Tube 56.5cm x 12.8cm x 12.3cm
- ◆ Tape & Reel 34.2cm x 34.2cm x 14.0cm

Carton Dimension

- ◆ Tube
 - 2 Boxes..... 58.0cm x 28.0cm x 14.5cm
 - 4 Boxes..... 58.0cm x 28.0cm x 26.0cm
- ◆ Tape & Reel
 - 1 Box..... 34.2cm x 34.2cm x 14.0cm
 - 2 Boxes..... 36.0cm x 27.5cm x 37.0cm