

Description

The LM3D65N06 uses advanced technology to provide excellent $R_{DS(ON)}$, low gate charge and operation with gate voltages as low as 4.5V. This device is suitable for use as a Battery protection or in other Switching application.

General Features

$V_{DS} = 60V$ $I_D = 65A$

$R_{DS(ON)} < 10m\Omega$ @ $V_{GS}=10V$ (Type: 7.5m Ω)

Application

Battery protection

Load switch

Uninterruptible power supply

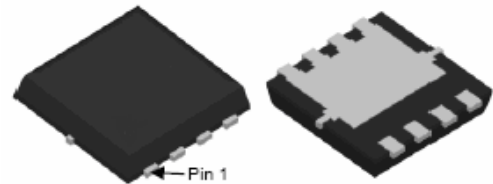
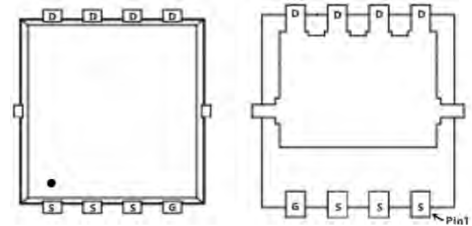
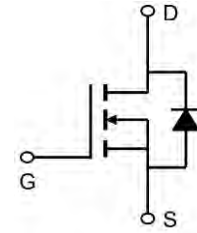

Package Marking and Ordering Information

Product ID	Pack	Marking	Qty(PCS)
LM3D65N06	DFN3*3-8L	AP65N06DF XXX YYYY	5000PCS

Absolute Maximum Ratings@ $T_j=25^\circ C$ (unless otherwise specified)

Symbol	Parameter	Value	Unit
VDS	Drain source voltage	60	V
VGS	Gate source voltage	± 20	V
$I_D@T_A=25^\circ C$	Continuous drain current	20	A
$I_D@T_A=70^\circ C$	Continuous drain current	11	A
IDM	Pulsed drain current	60	A
$P_D@T_A=25^\circ C$	Power dissipation	60	W
EAS	Single pulsed avalanche energy	30	mJ
TSTG	Storage Temperature Range	-55 to 150	$^\circ C$
T_j	Operation and storage temperature	-55 to 150	$^\circ C$
R θ JC	Thermal resistance, junction-case	2.1	$^\circ C/W$
R θ JA	Thermal resistance, junction-ambient5)	85	$^\circ C/W$

Electrical Characteristics ($T_J=25^\circ\text{C}$, unless otherwise noted)

Symbol	Parameter	Test condition	Min.	Typ.	Max.	Unit
BVDSS	Drain-source breakdown voltage	$V_{GS}=0\text{ V}$, $I_D=250\ \mu\text{A}$	60	68		V
VGS(th)	Gate threshold voltage	$V_{DS}=V_{GS}$, $I_D=250\ \mu\text{A}$	1.2	1.5	2.5	V
RDS(ON)	Drain-source on-state resistance	$V_{GS}=10\text{ V}$, $I_D=20\text{ A}$		7.5	10	m Ω
RDS(ON)	Drain-source on-state resistance	$V_{GS}=4.5\text{ V}$, $I_D=10\text{ A}$		10	13	m Ω
IGSS	Gate-source leakage current	$V_{GS}=\pm 20\text{ V}$			± 100	nA
IDSS	Drain-source leakage current	$V_{DS}=60\text{ V}$, $V_{GS}=0\text{ V}$			1	μA
Ciss	Input capacitance	$V_{GS}=0\text{ V}$, $V_{DS}=50\text{ V}$, $f=100\text{ kHz}$		1182.1		pF
Coss	Output capacitance			199.5		pF
Crss	Reverse transfer capacitance			4.1		pF
td(on)	Turn-on delay time	$V_{GS}=10\text{ V}$, $V_{DS}=50\text{ V}$, $R_G=2\ \Omega$, $I_D=10\text{ A}$		17.9		ns
t _r	Rise time			4.0		ns
td(off)	Turn-off delay time			34.9		ns
t _f	Fall time			5.5		ns
Q _g	Total gate charge	$I_D=10\text{ A}$, $V_{DS}=50\text{ V}$, $V_{GS}=10\text{ V}$		18.4		nC
Q _{gs}	Gate-source charge			3.3		nC
Q _{gd}	Gate-drain charge			3.1		nC
V _{plateau}	Gate plateau voltage			2.8		V
I _s	Diode forward current	$V_{GS}<V_{th}$			60	A
ISP	Pulsed source current				180	
VSD	Diode forward voltage	$I_S=20\text{ A}$, $V_{GS}=0\text{ V}$			1.3	V
trr	Reverse recovery time	$I_S=10\text{ A}$, $di/dt=100\text{ A}/\mu\text{s}$		41.8		ns
Q _{rr}	Reverse recovery charge			36.1		nC
I _{rrm}	Peak reverse recovery current			1.4		A

Note

1. Calculated continuous current based on maximum allowable junction temperature.
2. Repetitive rating; pulse width limited by max. junction temperature.
3. Pd is based on max. junction temperature, using junction-case thermal resistance.
4. $V_{DD}=50\text{ V}$, $R_G=50\ \Omega$, $L=0.3\text{ mH}$, starting $T_J=25^\circ\text{C}$.
5. The value of $R_{\theta JA}$ is measured with the device mounted on 1 in 2 FR-4 board with 2oz. Copper, in a still air environment with $T_a=25^\circ\text{C}$.

Typical Characteristics

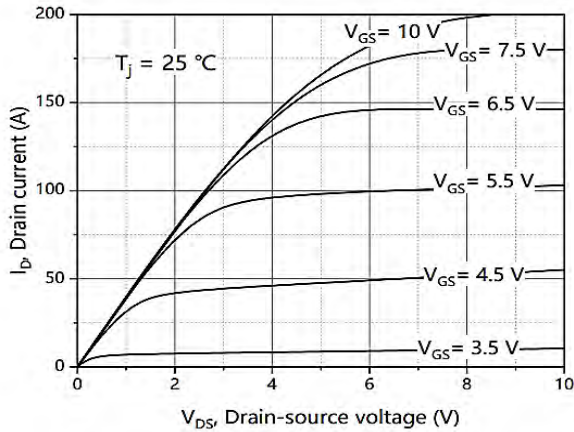

Figure 1. Typ. output characteristics

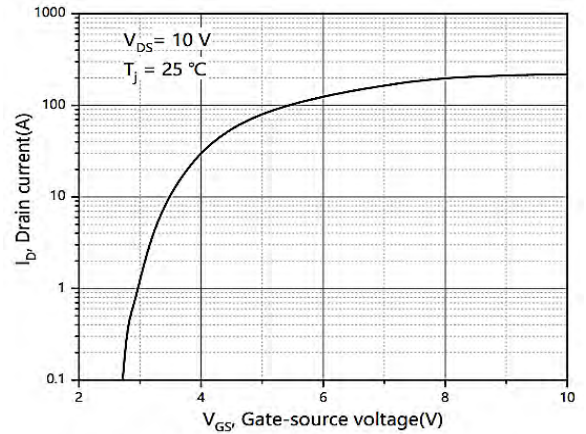

Figure 2. Typ. transfer characteristics

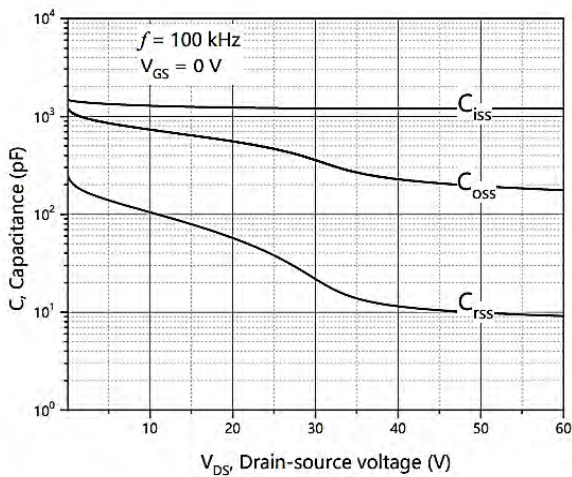

Figure 3. Typ. capacitances

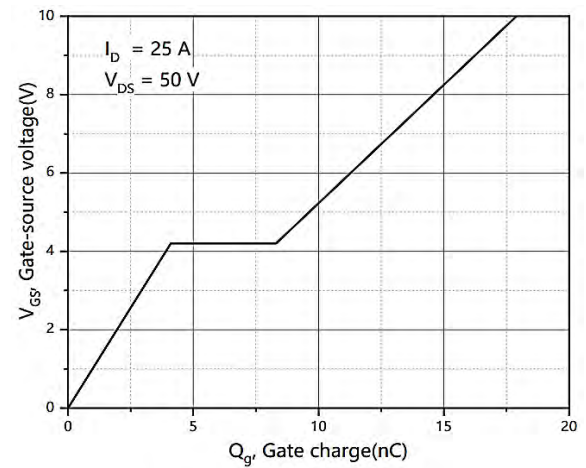

Figure 4. Typ. gate charge

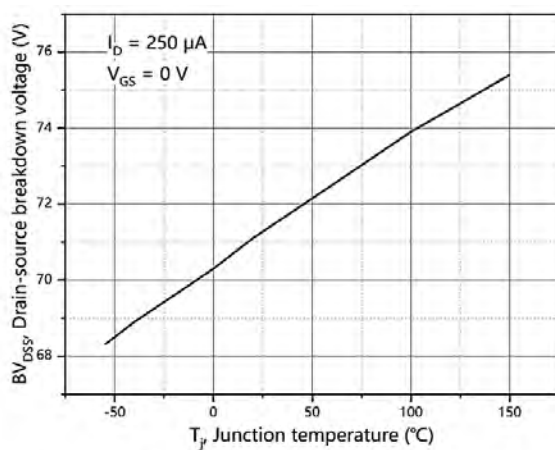

Figure 5. Drain-source breakdown voltage

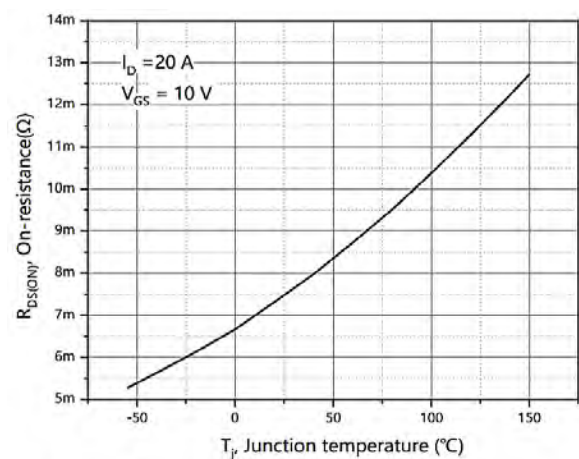

Figure 6. Drain-source on-state resistance

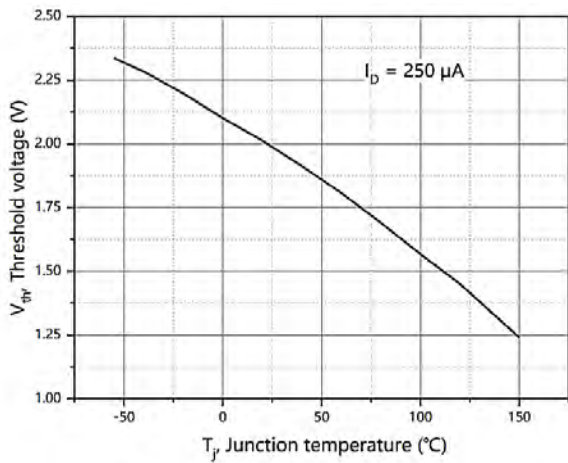

Figure 7. Threshold voltage

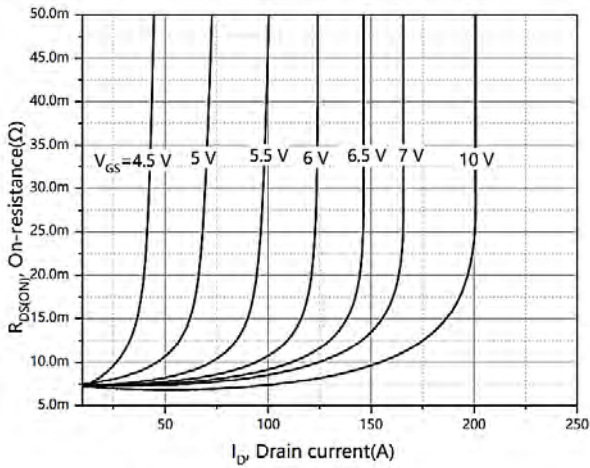

Figure 9. Drain-source on-state resistance

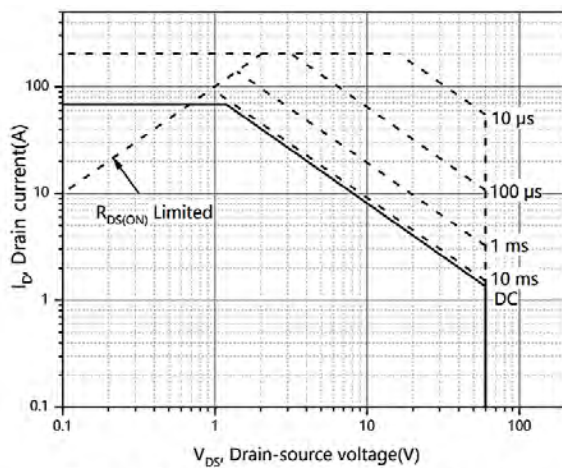

Figure 11. Safe operation area $T_C=25\text{ }^\circ\text{C}$

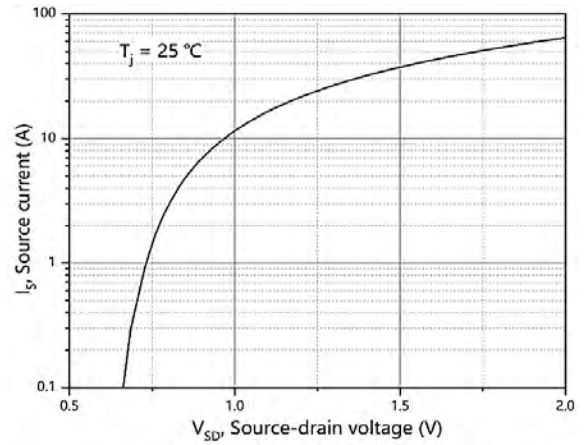

Figure 8. Forward characteristic of body diode

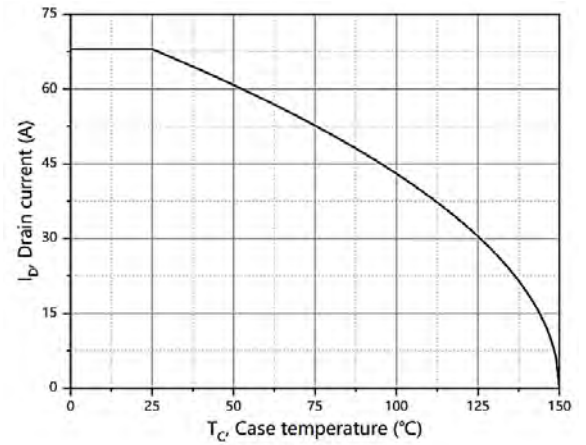

Figure 10. Drain current

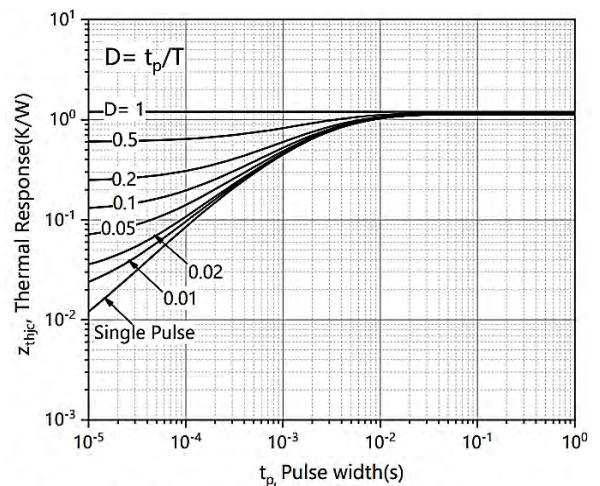
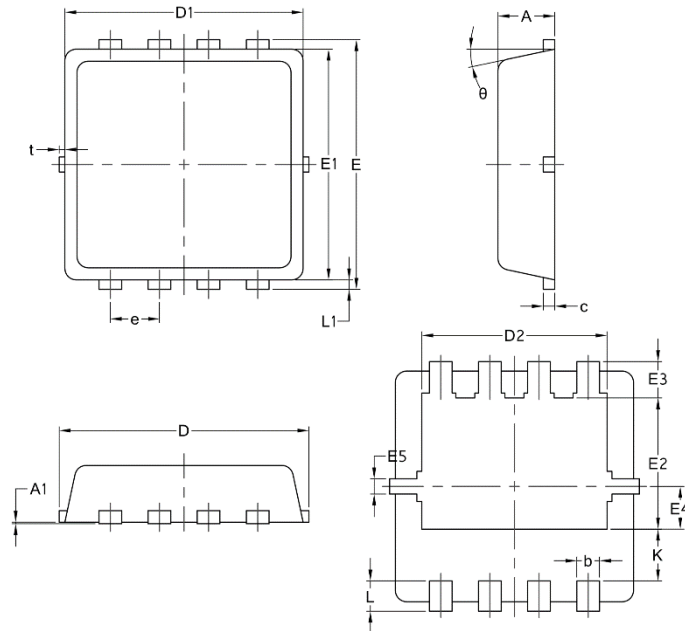

Figure 12. Max. transient thermal impedance

Package Mechanical Data-DFN3*3-8L Single



Symbol	Common		
	mm		
	Mim	Nom	Max
A	0.70	0.75	0.85
A1	/	/	0.05
b	0.20	0.30	0.40
c	0.10	0.152	0.25
D	3.15	3.30	3.45
D1	3.00	3.15	3.25
D2	2.29	2.45	2.65
E	3.15	3.30	3.45
E1	2.90	3.05	3.20
E2	1.54	1.74	1.94
E3	0.28	0.48	0.65
E4	0.37	0.57	0.77
E5	0.10	0.20	0.30
e	0.60	0.65	0.70
K	0.59	0.69	0.89
L	0.30	0.40	0.50
L1	0.06	0.125	0.20
t	0	0.075	0.13
Φ	10	12	14