

Description

U6110 is a low cost, highly integrated PWM power switch for non-isolated buck and buck-boost applications.

U6110 combines a 500V power MOSFET with the ON/OFF PWM controller in one chip. The IC can achieve high precision 5V default Output at universal AC input. In U6110, PWM switching frequency with shuffling is fixed to 31KHz. The IC has built-in green mode control for light and zero loadings, which can achieve less than 50mW standby power.

U6110 integrates functions and protections of Under Voltage Lockout (UVLO), Cycle-by-cycle Current Limiting (OCP), On-chip Thermal Shutdown (OTP), Over Load Protection (OLP) Short Load Protection (SLP), etc.

Features

- High Precision 5V Default Output
- Integrated with 500V MOSFET
- High Voltage Startup Circuit
- Ultra Low System BOM Cost
- Support Buck and Buck/Boost Topology
- On/OFF Peak Current Mode Control
- Less than 50mW Standby Power
- Built-in 31KHz Oscillator with Frequency
- Built-in Soft Start
- Very Low VDD Operation Current
- Build in Protections:
 - Over Load Protection (OLP)
 - On-Chip Thermal Shutdown (OTP)
 - Cycle-by-Cycle Current Limiting (OCP)
 - Leading Edge Blanking (LEB)
 - VDD UVLO
- Package SOT-23-3L

Applications

- Small Home Appliance
- Linear Regulator/RCC Replacement •

Package Information

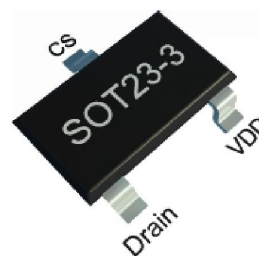

Pin Configuration

TO-92	SOT23-3L	Pin Name	I/O	Description
1	1	Drain	P	Internal power MOSFET drain
3	2	VDD	P	Power Supply Pin of the Chip
2	3	CS	P	The Ground of the IC. This pin is also used for peak current control

Typical Application

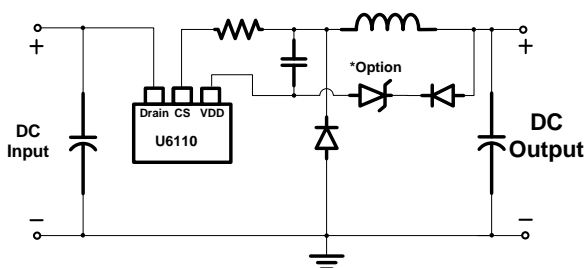

Buck Converter

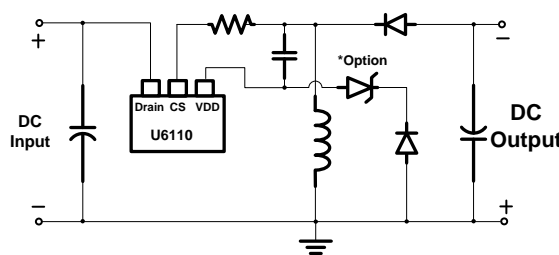

Buck/Boost Converter

n Block Diagram

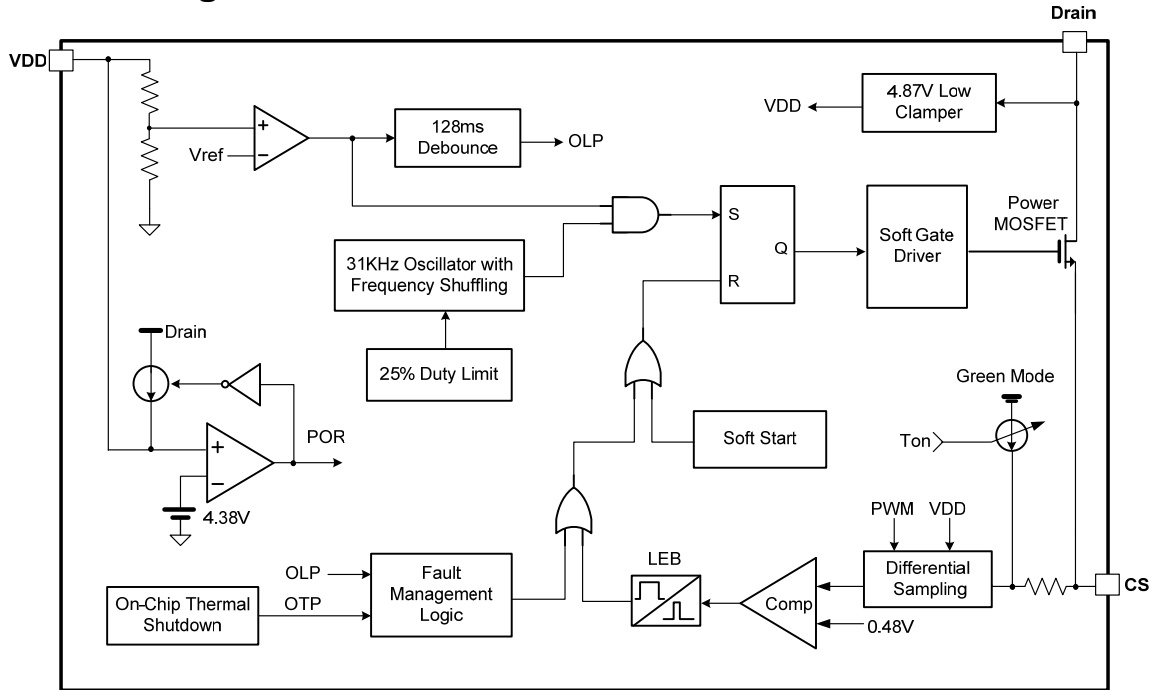

n Absolute Maximum Ratings (Note 1)

Parameter	Value	Unit
VDD DC Supply Voltage	7	V
Drain pin	-0.3 to 500	V
Package Thermal Resistance (TO-92)	120	°C/W
Package Thermal Resistance (SOT23-3L)	260	°C/W
Maximum Junction Temperature	160	°C
Storage Temperature Range	-65 to 150	°C
Lead Temperature (Soldering, 10sec.)	260	°C
ESD Capability, HBM (Human Body Model)	3	kV
ESD Capability, MM (Machine Model)	250	V

n Recommended Operation Conditions (Note 2)

Parameter	Value	Unit
Operating Junction Temperature	-40 to 125	°C

n Electrical Characteristics (Ta = 25°C, if not otherwise noted)

Symbol	Parameter	Test Conditions	Min	Typ.	Max	Unit
Supply Voltage Section(VDD Pin)						
$I_{VDD_standby}$	Standby Operation Current	VDD=6V		150	300	uA
V_{DD_Op}	VDD Operation Voltage	@ Full Load	5.34	5.46	5.58	V
V_{DD_OFF}	VDD Under Voltage Lockout Enter			4.38		V
V_{DD_ON}	VDD Under Voltage Lockout Exit			4.87		V
V_{out_Reg}	System Output Regulation Voltage		4.95	5	5.075	V
Oscillator Section						
F_{OSC}	Oscillator Frequency	VDD=5.46V	28.2	31	34.5	KHz
$\Delta F(\text{shuffle}) / F_{OSC}$	Frequency Shuffling Range		-5		5	%
$T(\text{shuffle})$	Frequency Shuffling Period			32		ms
D_{MAX}	Maximum PWM Switching Duty Cycle	(Note 3)	24.9	25	25.1	%
T_{D_OLP}	Over Loading Debounce Time	VDD=5.46V		128		ms
Current Sense Input Section (CS Pin)						
T_{LEB}	CS Input Leading Edge Blanking Time			300		ns
$V_{cs(max)}$	Current limiting threshold		440	480	520	mV
T_{D_OCP}	Over Current Detection and Control Delay			100		ns
Over Temperature Protection						
T_{SD}	Thermal Shutdown Trigger Point	(Note 3)		155		° C
Power MOSFET Section (Drain Pin)						
V_{BR}	Power MOSFET Drain Source Breakdown Voltage		500			V
R_{dson}	Static Drain-Source On Resistance	I(Drain)=50mA		13		ohm
$I_{Drain_to_VDD}$	High Voltage VDD Charging Current Source	Drain=500V, VDD=0V		1	3	mA
$I_{Drain_leakage}$	Drain Leakage Current	HV=500V, VDD=6V			50	uA

Note1. Stresses listed as the above "Maximum Ratings" may cause permanent damage to the device. These are for stress ratings. Functional operation of the device at these or any other conditions beyond those indicated in the operational sections of the specifications is not implied. Exposure to maximum rating conditions for extended periods may remain possibility to affect device reliability.

Note2. The device is not guaranteed to function outside its operating conditions.

Note3. Guaranteed by design.

Note4. Devices are ESD sensitive. Handling precaution is recommended.

n Typical Characteristics

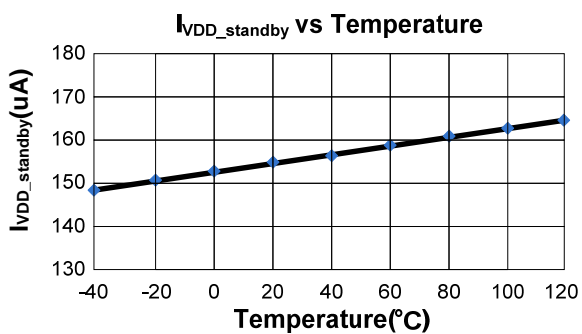
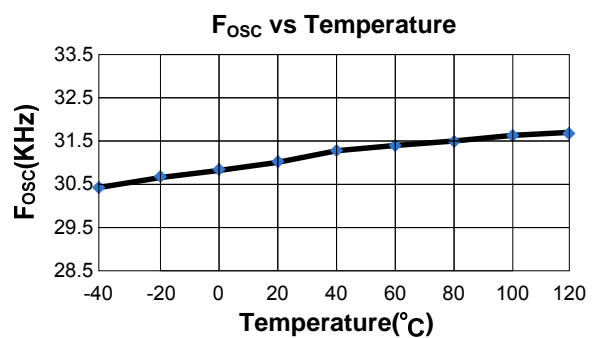
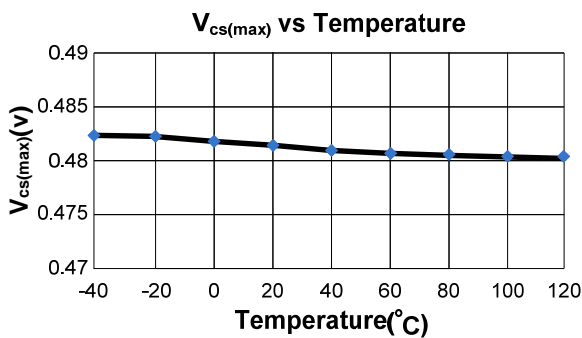
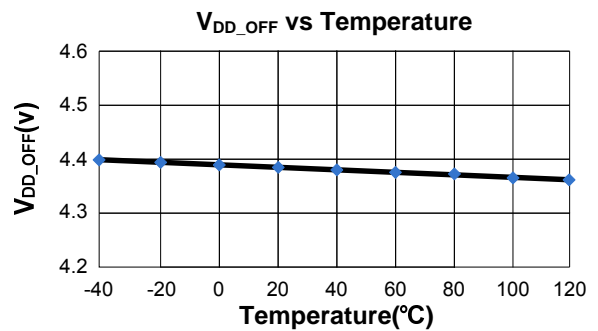
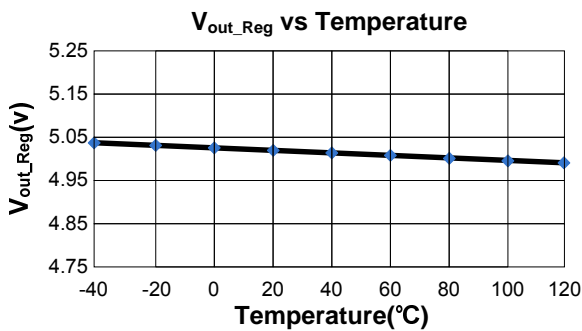

n Operation Description

U6110 combines a high voltage power MOSFET switch with power controller in one chip. It is optimized for off-line non-isolated buck or buck-boost applications for small home appliances and linear regulator replacement. The IC utilizes the ON/OFF current mode PWM control to regulate a 5V default output with high precision and lowest components count.

- **Very Low Operation Current**

The standby operating current in U6110 is as small as 150uA (typical). The small operating current results in higher efficiency and reduces the VDD hold-up capacitance requirement. Normally 0.1-1uF ceramic capacitor is recommended.

- **Oscillator with Frequency Shuffling**

PWM switching frequency in U6110 is fixed to 31KHz. To improve system EMI performance, U6110 operates the system with +5% frequency shuffling around setting frequency. The practical system switching frequency is determined by the load condition and the comparison of VDD voltage over output reference, which cause system works in the pulse-skipping mode.

- **Current Limit and Leading Edge Blanking**

The current limit circuit samples the differential voltage between VDD and CS, as shown in “Block Diagram”. When the sampled differential voltage exceeds the internal threshold, the power MOSFET is turned off for the remainder of that cycle. An internal leading edge blanking circuit is built in. During this blanking period (300ns, typical), the cycle-by-cycle current limiting comparator is disabled and cannot switch off the GATE driver.

- **Green Mode Operation**

In light/zero load condition, the system usually works in DCM mode. Therefore, the main power dissipation is proportional to the square of peak current limit. In U6110, the IC can automatically

reduce the peak current limit under such load conditions, thus less than 50mW standby power can be achieved.

- **Soft Start**

U6110 features an internal 4ms (typical) soft start that slowly increases the threshold of cycle-by-cycle current limiting comparator during startup sequence. Every restart attempt is followed by the soft start activation.

- **Over Load Protection (OLP) /Short Load Protection (SLP)**

If over load or short load occurs, a fault is detected. If this fault is present for more than 128ms (typical), the protection will be triggered, the IC will experience an auto-restart mode protection as mentioned below.

- **On Chip Thermal Shutdown(OTP)**

U6110 integrates thermal shutdown function. When the IC temperature is over 155 °C, the IC shuts down and enters into auto-restart mode as mentioned below.

- **Protections with Auto-Restart**

In the event of OTP or OLP, the IC enters into auto-restart and VDD oscillation mode begins, wherein the power MOSFET is disabled. In VDD oscillation mode, the VDD hold-up capacitor voltage will periodically ramp up and down between 4.87V and 4.38V with a digital counter counting the oscillation cycle. When 511 cycles had been counted, the IC will reset and start up the system again. However, if the fault still exists, the system will experience the above mentioned process.

- **Soft Totem-Pole Gate Driver**

U6110 has a soft totem-pole gate driver with optimized EMI performance.

n Package Dimensions

SOT23-3L

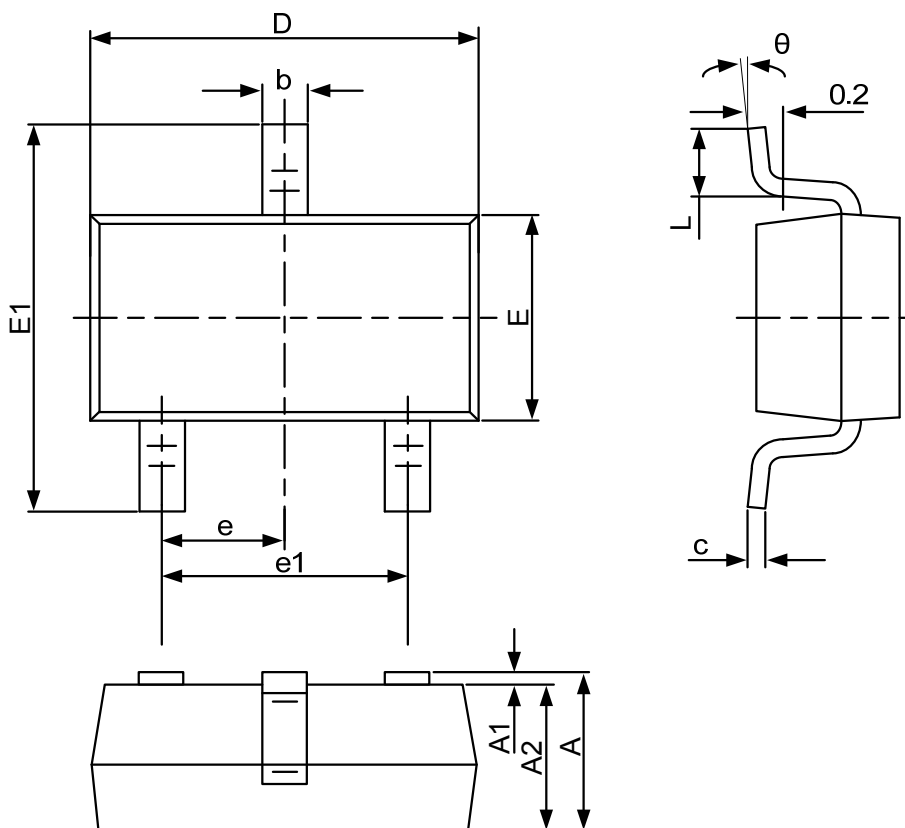

Symbol	Dimensions In Millimeters		Dimensions In Inches	
	Min	Max	Min	Max
A	1.050	1.250	0.041	0.049
A1	0.000	0.100	0.000	0.004
A2	1.050	1.150	0.041	0.045
b	0.300	0.500	0.012	0.020
c	0.100	0.200	0.004	0.008
D	2.820	3.020	0.111	0.119
E	1.500	1.700	0.059	0.067
E1	2.650	2.950	0.104	0.116
e	0.950(BSC)		0.037(BSC)	
e1	1.800	2.000	0.071	0.079
L	0.300	0.600	0.012	0.024
θ	0°	8°	0°	8°