

## General Description

This product family is CRM's second generation SiC JBS, with lower VF and offers state of the art performance. It is designed for high frequency applications where high efficiency and high reliability are required. It is qualified and manufactured on the productive 6 inch SiC line in China fully owned by CR MICRO.

## Product Summary

$V_{RRM}$	1200 V
$I_F (T_C=155^\circ\text{C})$	30 A
$Q_C$	135 nC

## Features

- Low conduction loss due to low  $V_F$
- Extremely low switching loss by tiny  $Q_C$
- Highly rugged due to better surge current
- Industrial standard quality and reliability



## Applications

- Solar inverter
- EV charge
- High performance SMPS
- Power factor correction

**TO-247-2**



**Equivalent circuit**



## Package Marking and Ordering Information

Part #	Marking	Package
CRXU30D120G2	CRXU30D120G2	TO-247-2

**Maximum Ratings (at  $T_c = 25\text{ }^\circ\text{C}$ , unless otherwise specified)**

Parameter	Symbol	Value	Unit
Repetitive Peak Reverse Voltage	$V_{RRM}$	1200	V
Surge Peak Reverse Voltage	$V_{RSM}$	1200	V
DC Peak Reverse Voltage	$V_R$	1200	V
Continuous Forward Current $T_c = 25^\circ\text{C}$ $T_c = 135^\circ\text{C}$ $T_c = 155^\circ\text{C}$	$I_F$	83 43 30	A
Non-Repetitive Forward Surge Current $T_c = 25^\circ\text{C}, t_p=8.3\text{ms}, \text{Half Sine Pulse}$ $T_c = 110^\circ\text{C}, t_p=8.3\text{ms}, \text{Half Sine Pulse}$	$I_{FSM}$	240 210	A
Non-Repetitive Forward Surge Current $T_c = 25^\circ\text{C}, t_p=8.3\text{ms}, \text{Half Sine Pulse}$ $T_c = 110^\circ\text{C}, t_p=8.3\text{ms}, \text{Half Sine Pulse}$	$\int i^2 dt$	239 183	$\text{A}^2\text{s}$
Power dissipation $T_c = 25^\circ\text{C}$ $T_c = 110^\circ\text{C}$	$P_{tot}$	272 118	W
Operating junction Range	$T_j$	-55 to +175	$^\circ\text{C}$
Storage temperature Range	$T_{stg}$	-55 to +150	$^\circ\text{C}$

**Thermal Resistance**

Parameter	Symbol	Typ.	Unit
Thermal resistance, junction – case.	$R_{thJC}$	0.55	°C/W

**Electrical Characteristic (at  $T_c = 25\text{ °C}$ , unless otherwise specified)**

Parameter	Symbol	Value			Unit	Test Condition
		min.	typ.	max.		
Forward Voltage	$V_F$	-	1.4	1.7	V	$I_F=30A$ $T_j=25\text{°C}$ $T_j=175\text{°C}$
Reverse Current	$I_R$	-	5	100	$\mu A$	$V_R=1200V$ $T_j=25\text{°C}$ $T_j=175\text{°C}$
Total Capacitive Charge	$Q_C$	-	135	-	nC	$V_R=800V, T_j=25\text{°C}$ $Q_C = \int_0^{V_R} C(V)dV$
Total Capacitance	C	-	2050	-	pF	$T_j=25\text{°C}, f=1MHz$ $V_R=0V$ $V_R=400V$ $V_R=800V$

## Characteristics Curve:

Fig 1: Forward Characteristics

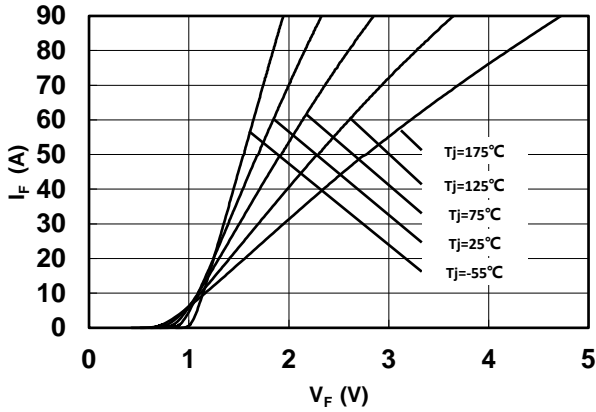

Fig 2: Reverse Characteristics

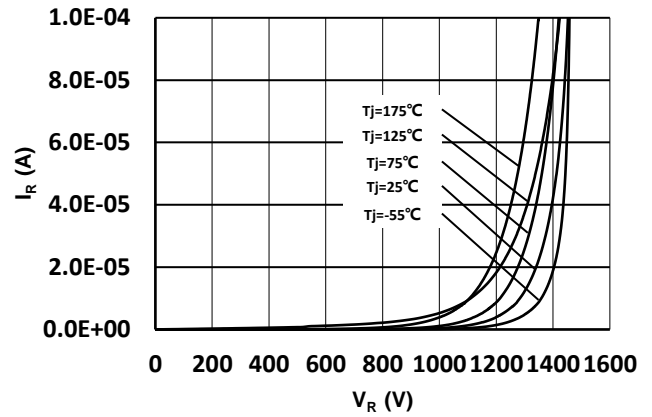

Fig 3: Current Derating

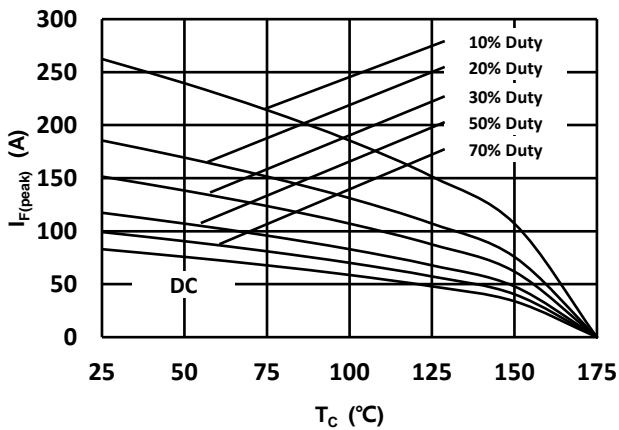

Fig 4: Power Derating

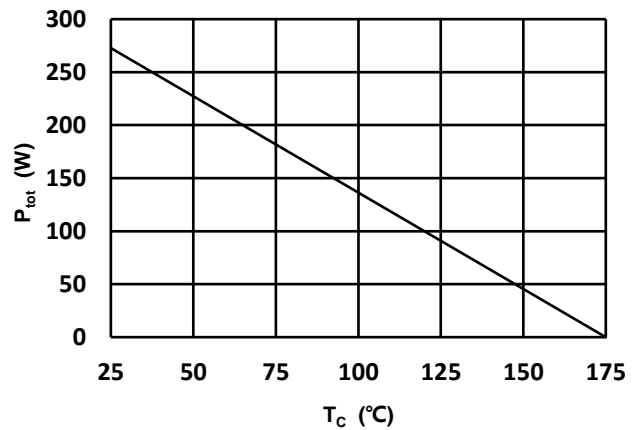

Fig 5: Capacitance vs. Reverse Voltage

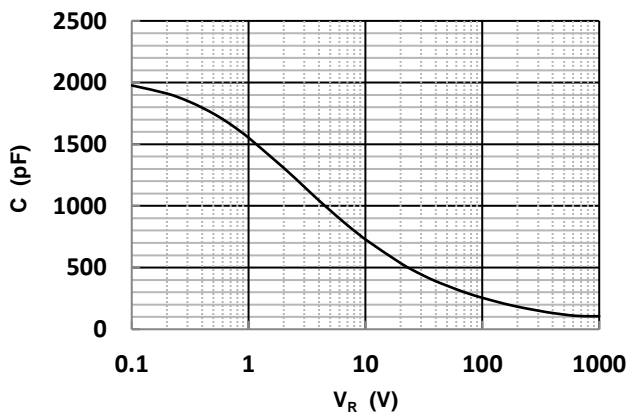

Fig 6: Reverse Charge vs. Reverse Voltage

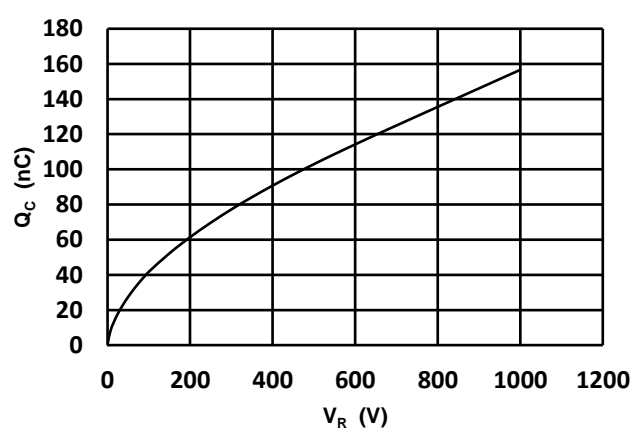

Fig 7: Typical Capacitance Stored Energy

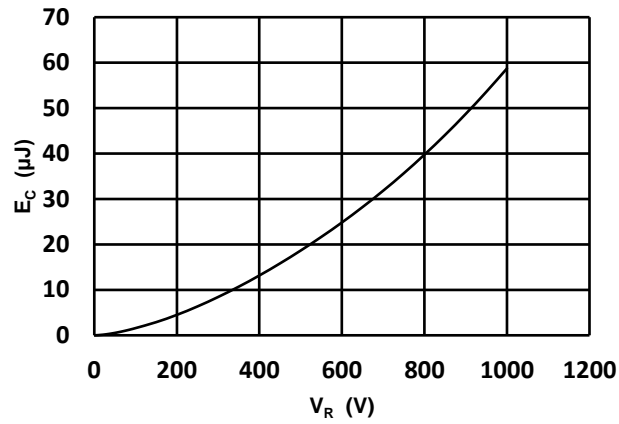
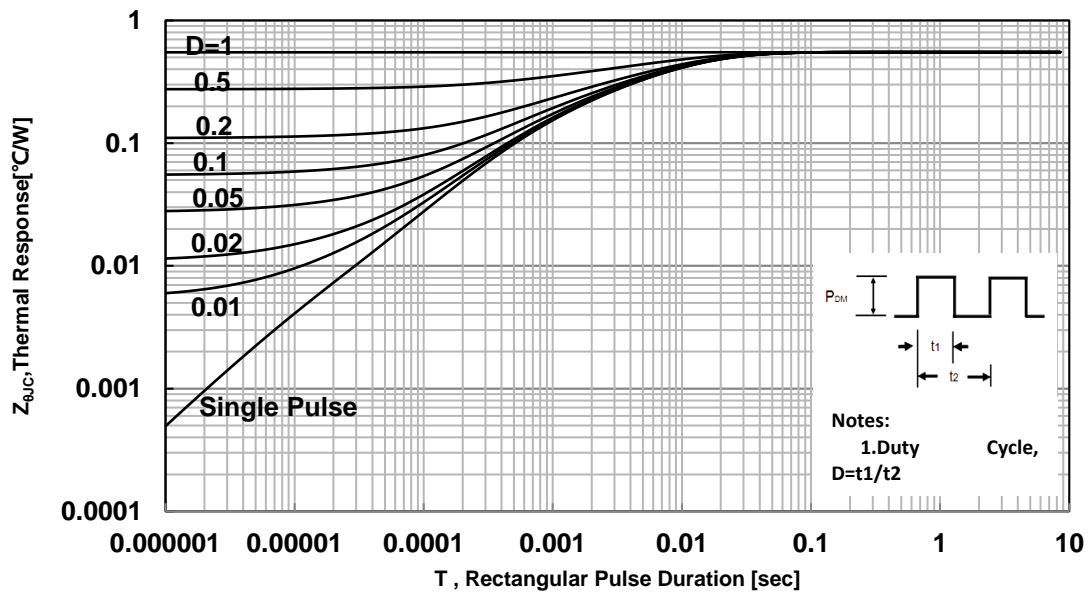
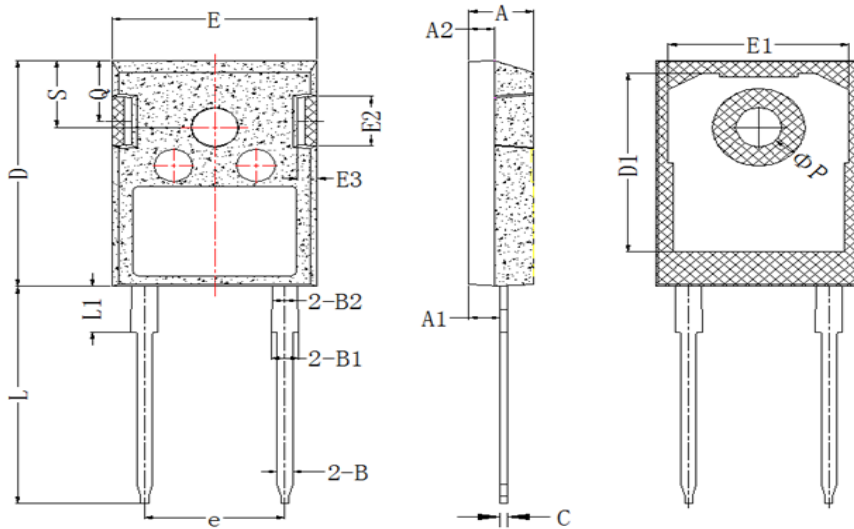

Fig 8: Transient Thermal Impedance



**Package Outline: TO-247-2**



Items	Values(mm)	
	MIN	MAX
A	4.85	5.15
A1	2.25	2.55
A2	1.85	2.15
B	1.04	1.33
B1	1.90	2.35
B2	1.90	2.15
C	0.55	0.68
D	20.80	21.10
D1	16.25	17.65
D2	0.95	1.35
E	15.70	16.10
E1	13.50	14.20
E2	3.80	5.00
E3	1.00	2.60
e	10.63	11.13
L	19.80	20.30
L1	4.00	4.50
φP	3.50	3.70
Q	5.40	6.00
S	6.00	6.40

---

**Revision History**

Revision	Date	Major changes
1.0		Release of formal version.

**Warnings**

Exceeding the maximum ratings of the device in performance may cause damage to the device, even the permanent failure, which may affect the dependability of the machine. It is suggested to be used under 80 percent of the maximum ratings of the device.

1. When installing the heatsink, please pay attention to the torsional moment and the smoothness of the heatsink.
2. This product has not been designed or tested for use in, and is not intended for use in, applications implanted into the human body nor in applications in which failure of the product could lead to death, personal injury or property damage, including but not limited to equipment used in the operation of nuclear facilities, life-support machines, cardiac defibrillators or similar emergency medical equipment, aircraft navigation or communication or control systems, or air traffic control systems.