

Features

- Enhancement mode
- Very low on-resistance $R_{DS(on)}$
- Fast Switching and High efficiency
- 100% Avalanche test

V_{DS}	80	V
$R_{DS(on),TYP}@ V_{GS}=10\text{ V}$	4.5	m Ω
I_D	160	A



Part ID	Package Type	Marking	Packing
VS8402ATH	TO-220AB	8402ATH	50pcs/Tube

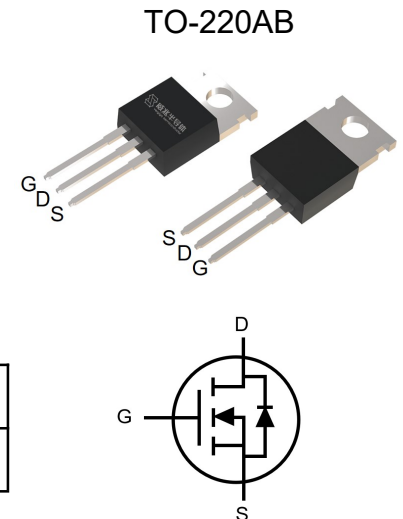

Maximum ratings, at $T_A = 25^\circ\text{C}$, unless otherwise specified

Symbol	Parameter	Rating	Unit	
$V_{(BR)DSS}$	Drain-Source breakdown voltage	80	V	
V_{GS}	Gate-Source voltage	± 25	V	
I_S	Diode continuous forward current	$T_C = 25^\circ\text{C}$	160	A
I_D	Continuous drain current @ $V_{GS}=10\text{V}$	$T_C = 25^\circ\text{C}$	160	A
		$T_C = 100^\circ\text{C}$	113	A
I_{DM}	Pulse drain current tested ①	$T_C = 25^\circ\text{C}$	640	A
I_{DSM}	Continuous drain current @ $V_{GS}=10\text{V}$	$T_A = 25^\circ\text{C}$	14	A
		$T_A = 70^\circ\text{C}$	11	A
E_{AS}	Avalanche energy, single pulsed ②	342	mJ	
P_D	Maximum power dissipation	$T_C = 25^\circ\text{C}$	259	W
P_{DSM}	Maximum power dissipation ③	$T_A = 25^\circ\text{C}$	2	W
$T_{STG,TJ}$	Storage and Junction Temperature Range	-55 to 175	$^\circ\text{C}$	

Thermal Characteristics

Symbol	Parameter	Typical	Max	Unit
$R_{\theta JC}$	Thermal Resistance, Junction-to-Case	0.58	0.7	$^\circ\text{C/W}$
$R_{\theta JA}$	Thermal Resistance, Junction-to-Ambient	62.5	75	$^\circ\text{C/W}$

Electrical Characteristics

Symbol	Parameter	Condition	Min.	Typ.	Max.	Unit
Static Electrical Characteristics @ T_j=25°C (unless otherwise stated)						
V(BR)DSS	Drain-Source Breakdown Voltage	V _{GS} =0V, I _D =250μA	80	--	--	V
IDSS	Zero Gate Voltage Drain Current	V _{DS} =80V, V _{GS} =0V	--	--	1	μA
	Zero Gate Voltage Drain Current(T _j =125°C)	V _{DS} =80V, V _{GS} =0V	--	--	100	μA
IGSS	Gate-Body Leakage Current	V _{GS} =±25V, V _{DS} =0V	--	--	±100	nA
V _{GS(th)}	Gate Threshold Voltage	V _{DS} =V _{GS} , I _D =250μA	2.6	3.1	3.6	V
R _{DS(on)}	Drain-Source On-State Resistance ④	V _{GS} =10V, I _D =80A	--	4.5	6	mΩ
		T _j =100°C	--	6.3	--	mΩ
Dynamic Electrical Characteristics @ T_j = 25°C (unless otherwise stated)						
C _{iss}	Input Capacitance	V _{DS} =30V, V _{GS} =0V, f=1MHz	6490	8655	11510	pF
C _{oss}	Output Capacitance		360	480	640	pF
C _{rss}	Reverse Transfer Capacitance		265	350	465	pF
R _g	Gate Resistance	f=1MHz	0.2	2.7	5	Ω
Q _g	Total Gate Charge	V _{DS} =40V, I _D =40A, V _{GS} =10V	--	144	192	nC
Q _{gs}	Gate-Source Charge		--	40	53	nC
Q _{gd}	Gate-Drain Charge		--	41	62	nC
Switching Characteristics						
T _{d(on)}	Turn-on Delay Time	V _{DD} =40V, I _D =40A, R _G =3Ω, V _{GS} =10V	--	22	--	ns
T _r	Turn-on Rise Time		--	85	--	ns
T _{d(off)}	Turn-Off Delay Time		--	101	--	ns
T _f	Turn-Off Fall Time		--	59	--	ns
Source- Drain Diode Characteristics@ T_j = 25°C (unless otherwise stated)						
V _{SD}	Forward on voltage	I _{SD} =80A, V _{GS} =0V	--	0.9	1.2	V
T _{rr}	Reverse Recovery Time	T _j =25°C, I _{sd} =40A, V _{GS} =0V	--	33	66	ns
Q _{rr}	Reverse Recovery Charge	di/dt=100A/μs	--	44	88	nC

NOTE: ① Repetitive rating; pulse width limited by max junction temperature.

② Limited by T_{Jmax}, starting T_J = 25°C, L = 0.5mH, R_G = 25Ω, I_{AS} = 37A, V_{GS} = 10V. Part not recommended for use above this value

③ The power dissipation P_{DSM} is based on R_{θJA} and the maximum allowed junction temperature of 150°C.

④ Pulse width ≤ 380μs; duty cycle ≤ 2%.

Typical Characteristics

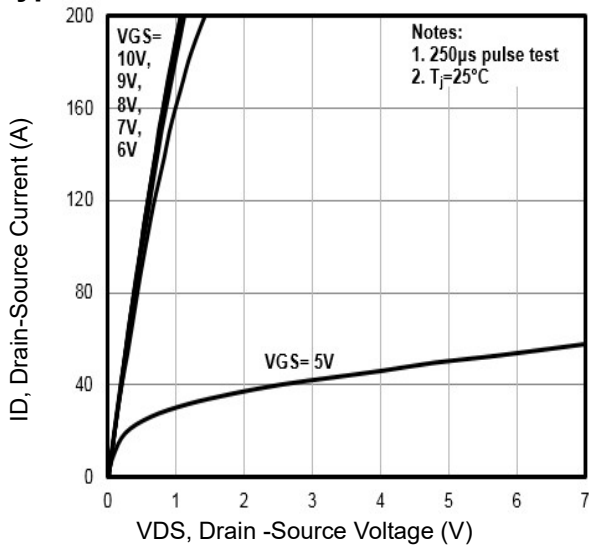

Fig1. Typical Output Characteristics

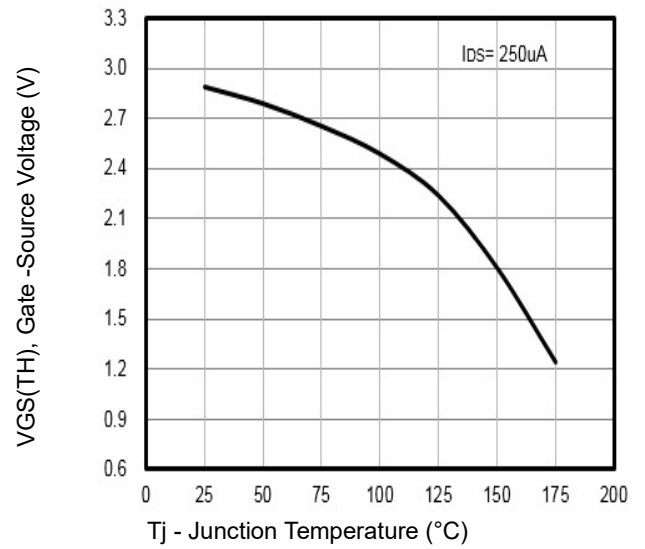

Fig2. $V_{GS(TH)}$ Gate -Source Voltage Vs. T_j

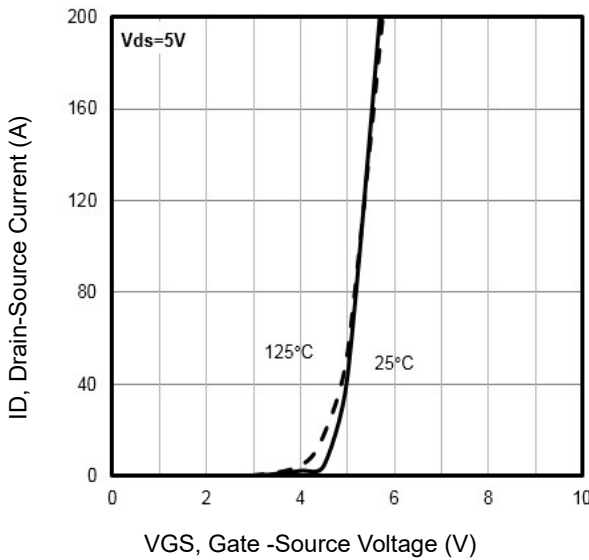

Fig3. Typical Transfer Characteristics

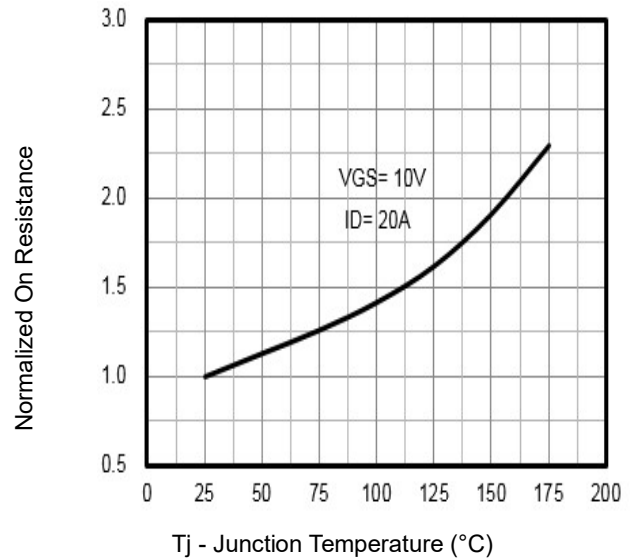

Fig4. Normalized On-Resistance Vs. T_j

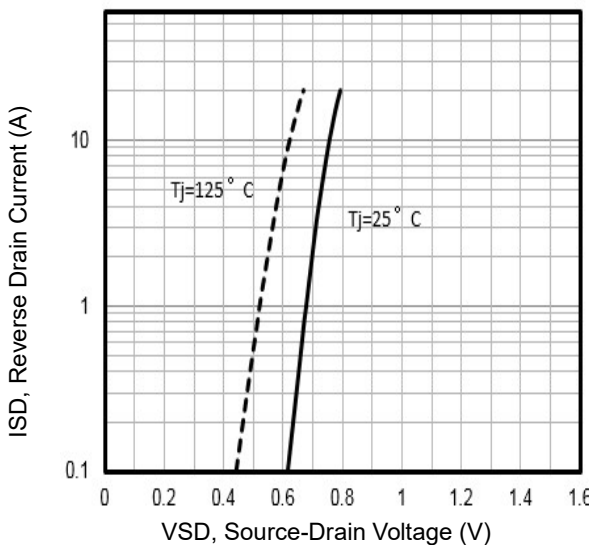

Fig5. Typical Source-Drain Diode Forward Voltage

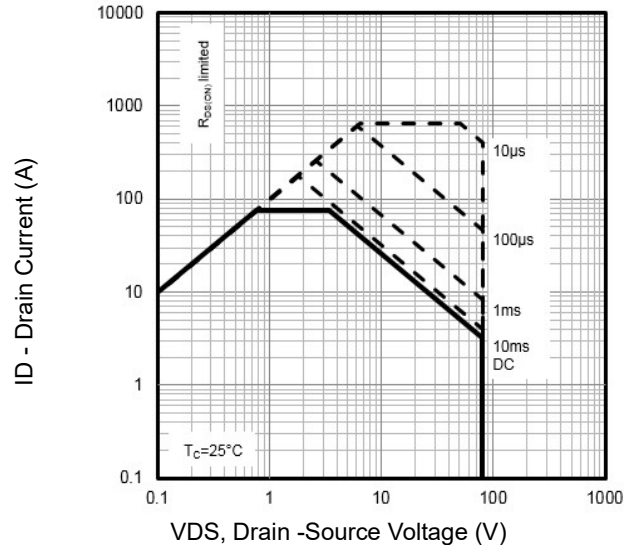

Fig6. Maximum Safe Operating Area

Typical Characteristics

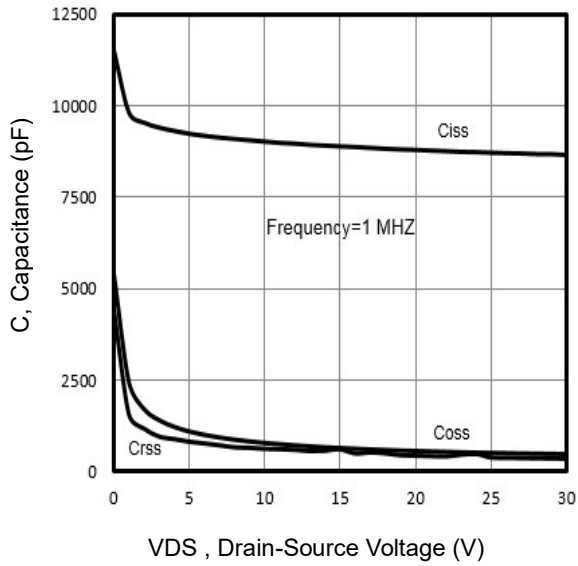

Fig7. Typical Capacitance Vs.Drain-Source Voltage

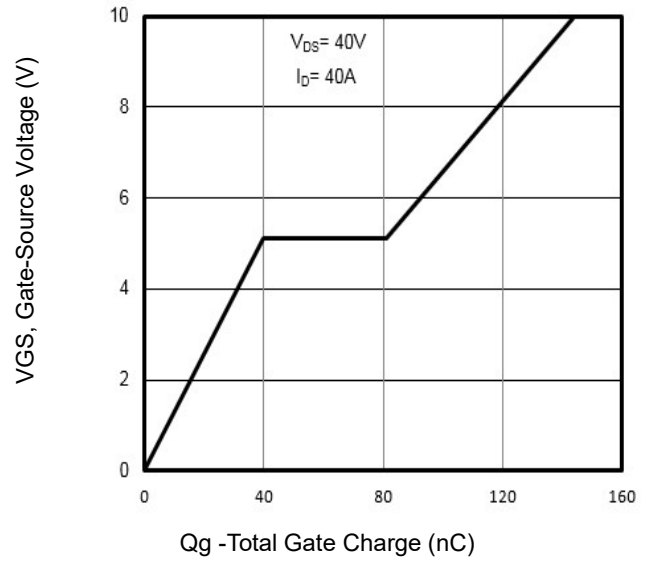

Fig8. Typical Gate Charge Vs.Gate-Source Voltage

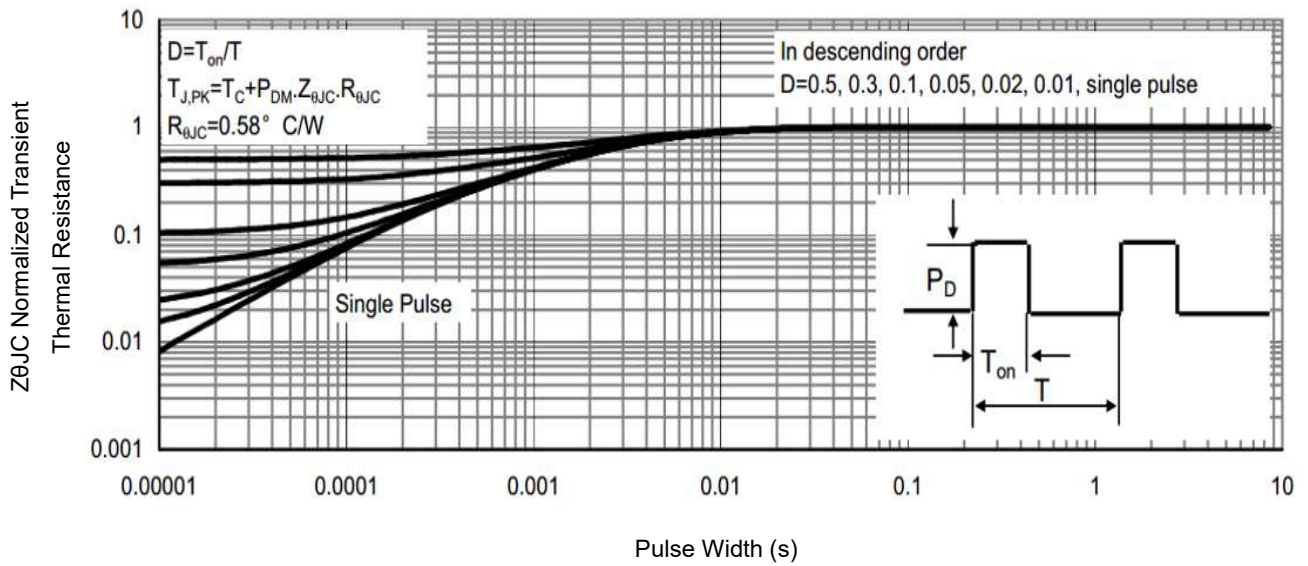

Fig9. Normalized Maximum Transient Thermal Impedance

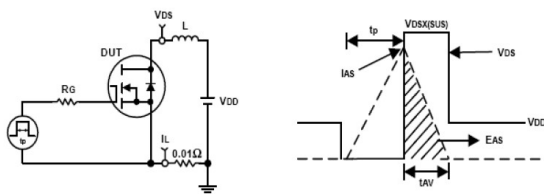

Fig10. Unclamped Inductive Test Circuit and waveforms

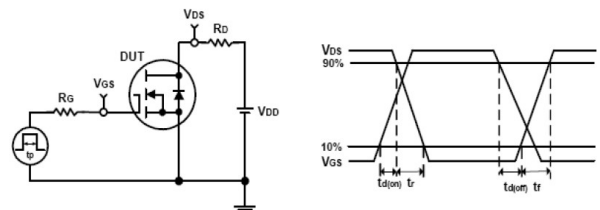
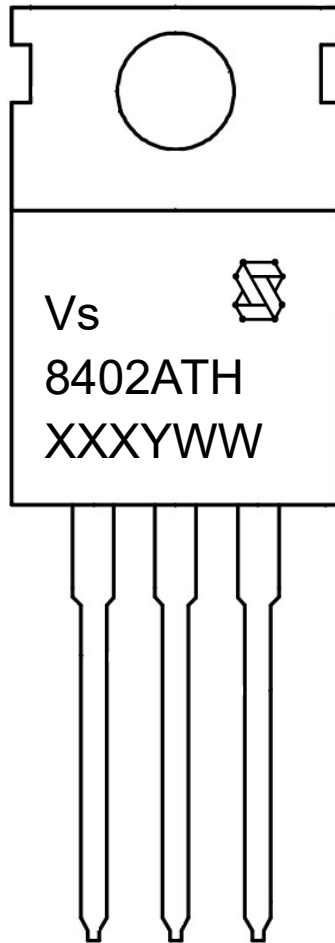

Fig11. Switching Time Test Circuit and waveforms

Marking Information



1st line: Vergiga Code (Vs), Vergiga Logo

2nd line: Part Number (8402ATH)

3rd line: Date code (XXXYWW)

XXX: Wafer Lot Number Code , code changed with Lot Number

Y: Year Code, refer to table below

WW: Week Code (01 to 53)

Code	C	D	E	F	G	H	J	K	L	M	N	P	Q	R	S	T
Year	2015	2016	2017	2018	2019	2020	2021	2022	2023	2024	2025	2026	2027	2028	2029	2030

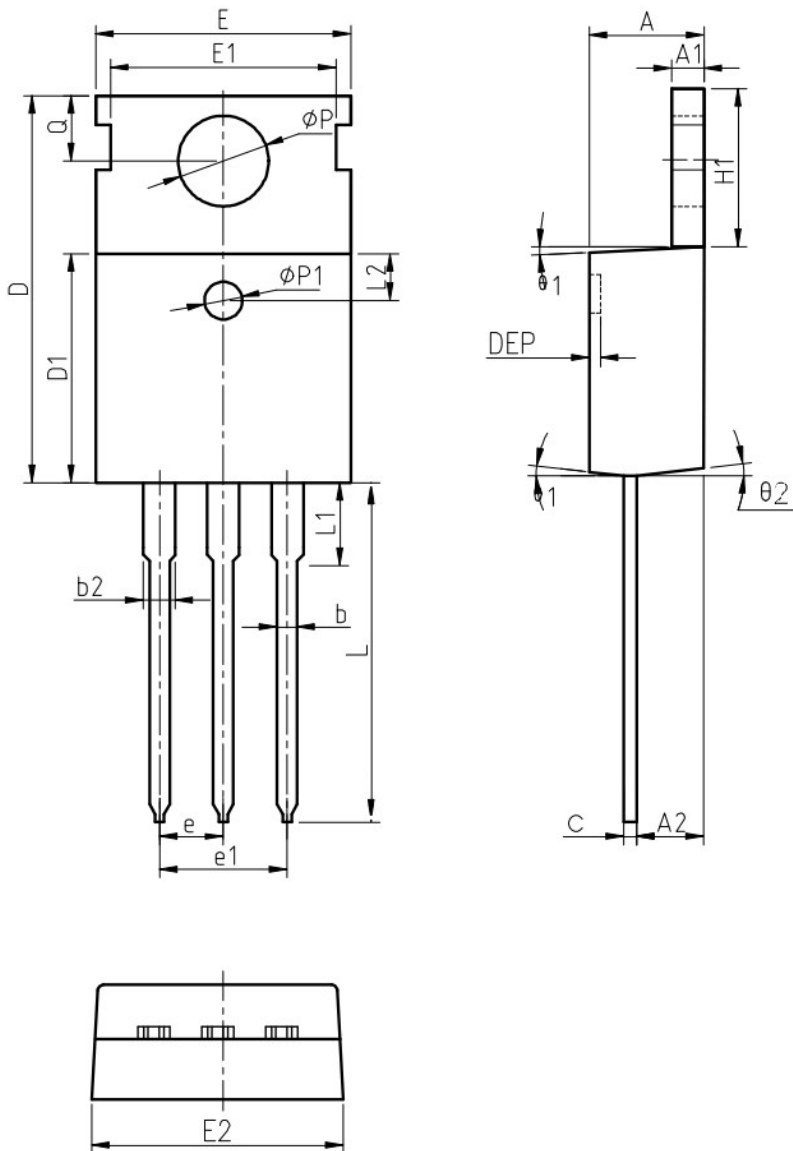
TO-220AB Package Outline Data

Symbol	Dimensions (unit: mm)		
	Min	Typ	Max
A	4.30	4.52	4.70
A1	1.15	1.30	1.40
A2	2.20	2.40	2.60
b	0.70	0.80	1.00
b2	1.17	1.32	1.50
c	0.45	0.50	0.61
D	15.30	15.65	15.90
D1	9.00	9.20	9.40
DEP	0.05	0.10	0.25
E	9.66	9.90	10.28
E1	-	8.70	-
E2	9.80	10.00	10.20
$\phi P1$	1.40	1.50	1.60
e	2.54 BSC		
e1	5.08 BSC		
H1	6.40	6.50	6.80
L	12.70	-	14.27
L1	-	-	3.95
L2	2.40	2.50	2.60
ϕP	3.53	3.60	3.70
Q	2.70	2.80	2.90
$\theta 1$	5 °	7 °	9 °
$\theta 2$	1 °	3 °	5 °

Notes:

1. Refer to JEDEC TO-220 variation AB
2. Dimension "D" and "E" do NOT include mold flash. Mold flash shall not exceed 0.127mm per side.

Customer Service
Sales and Service:
sales@vgsemi.com
Vergiga Semiconductor CO., LTD
TEL: (86-755) -26902410

FAX: (86-755) -26907027

WEB: www.vgsemi.com