

Features

- Low current rectification and high speed switching
- Small surface mount type
- Up to 200mA current capability
- Low forward voltage drop (0.35V typ. @IF=10mA)
Silicon epitaxial planar chip, metal silicon junction
- High speed (trr < 6 ns)
- Lead-free parts meet RoHS requirements
- Compliant to Halogen-free

Mechanical data

- Epoxy:UL94-V0 rated flame retardant
- Case : Molded plastic, SOD-323
- Terminals : Solder plated, solderable per MIL-STD-750, Method 2026
- Polarity : Indicated by cathode band
- Mounting Position : Any

Package outline

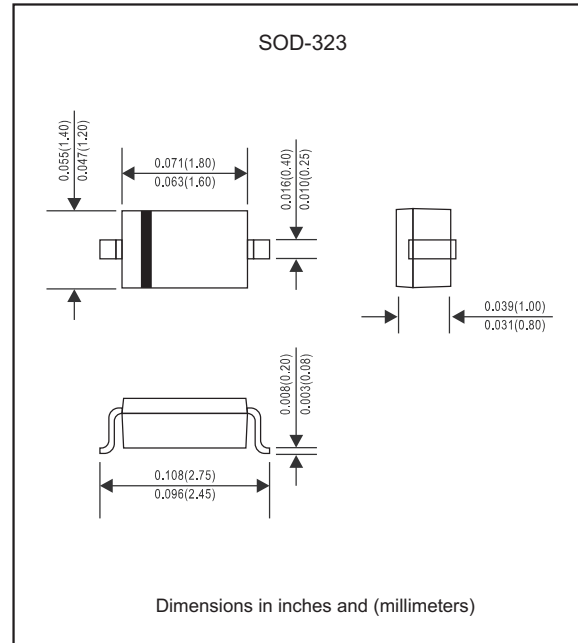

Maximum ratings (AT TA=25°C unless otherwise noted)

PARAMETER	CONDITIONS	Symbol	MIN.	TYP.	MAX.	UNIT
Repetitive peak reverse voltage		V_{RRM}			30	V
Reverse voltage		V_R			30	V
Repetitive peak forward current		I_{FRM}			300	mA
Non-repetitive peak forward current	t < 1.0 s	I_{FSM}			600	mA
Forward current		I_F			200	mA
Power dissipation	Mounted on FR-5 board at TA=25°C	P_D			200	mW
Thermal resistance	Junction to ambient	$R_{\theta JA}$		635		°C/W
Operating junction temperature range		T_J	-55		+125	°C
Storage temperature range		T_{STG}	-55		+125	°C

Electrical characteristics (AT TA=25°C unless otherwise noted)

PARAMETER	CONDITIONS	Symbol	MIN.	TYP.	MAX.	UNIT
Forward voltage	$I_F = 0.1 \text{ mA}$	V_F		0.220	0.240	V
	$I_F = 1 \text{ mA}$	V_F		0.290	0.320	V
	$I_F = 10 \text{ mA}$	V_F		0.350	0.400	V
	$I_F = 30 \text{ mA}$	V_F		0.410	0.500	V
	$I_F = 100 \text{ mA}$	V_F		0.520	1.000	V
Reverse current	$V_R = 25 \text{ V}$	I_R		0.5	2.0	uA
Total capacitance	$V_R = 1 \text{ V}, f = 1 \text{ MHz}$	C_T			10.0	pF
Reverse recovery time	$I_F = I_R = 10 \text{ mAdc}, I_{R(REC)} = 1.0 \text{ mAdc}$	trr			6.0	ns

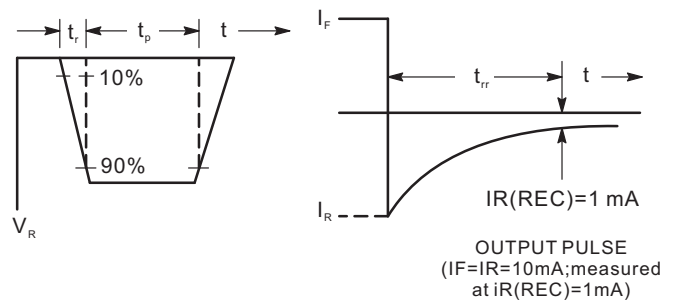
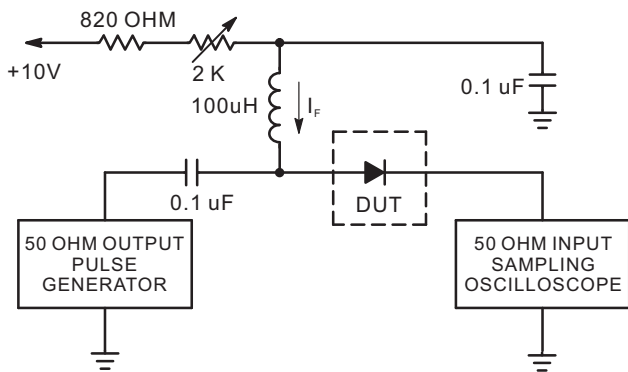
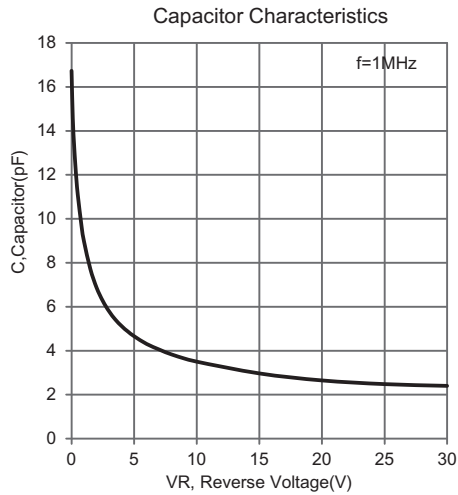
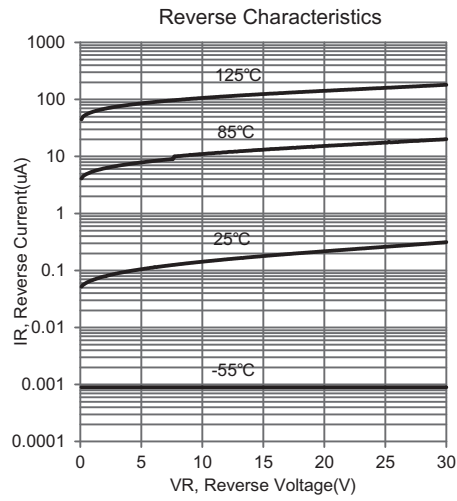
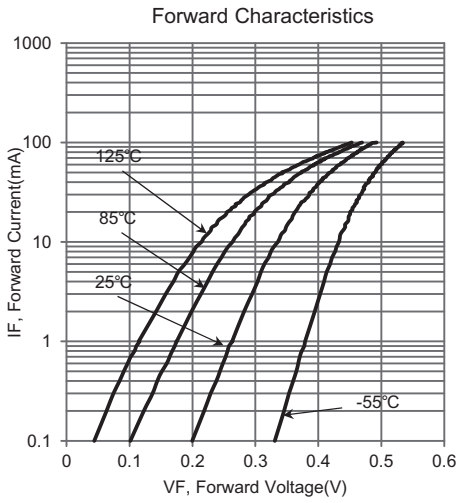

Rating and characteristic curves for each diode (BAT54WS)



- Notes : 1. A2.0 Kohm variable resistor adjusted for a forward Current (I_F) of 10mA.
 2. Input pulse is adjusted so $I_R(\text{peak})$ is equal to 10 mA.
 3. $t_p \gg t_{rr}$.

Recovery Time Equivalent Test Circuit

Pinning information

Pin	Simplified outline	Symbol
Pin1 cathode Pin2 anode		

Marking

Type number	Marking code
BAT54WS	L9 or S1

Suggested solder pad layout

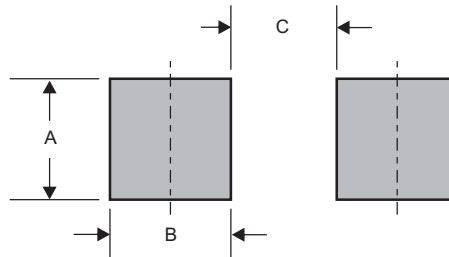

Dimensions in inches and (millimeters)

PACKAGE	A	B	C
SOD-323	0.032 (0.82)	0.022 (0.56)	0.069 (1.75)