



BPM0306CG

30V Complementary MOSFET

General Description

The BPM0306CG uses advanced trench technology to provide excellent $R_{DS(ON)}$ and low gate charge. The complementary MOSFETs can be used in a wide variety of applications.

Features

- **N-Channel**
 $V_{DS} = 30V, I_D = 6.5A$
 $R_{DS(ON)} < 30m\Omega @ V_{GS} = 10V$
- **P-Channel**
 $V_{DS} = -30V, I_D = -7A$
 $R_{DS(ON)} < 33m\Omega @ V_{GS} = -10V$
- High power and current handing capability

Application

- H-bridge
- Inverters

Typical Application

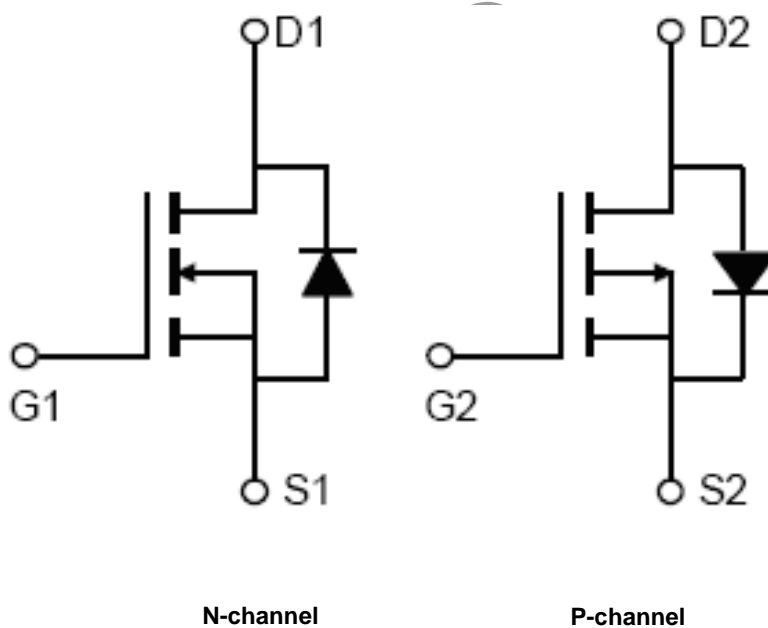

Figure 1. Schematic Diagram

Ordering Information

Part Number	Package	Operating Temperature	Packing Type	Marking
BPM0306CG	SOP-8	-40 °C to 105 °C	Tape & Reel 4,000pcs/Reel	BPM0306 XXXXXY CGXWW

Pin Configuration and Marking Information

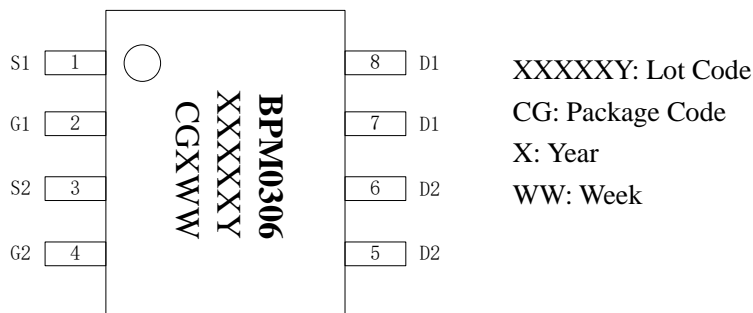

Figure 2. Pin Configuration

Pin Definition

Pin No.	Name	Description
1	S1	NMOS Source
2	G1	NMOS Gate
3	S2	PMOS Source
4	G2	PMOS Gate
5	D2	PMOS Drain
6	D2	PMOS Drain
7	D1	NMOS Drain
8	D1	NMOS Drain

Absolute Maximum Rating (note 1) (Unless otherwise specified, T_A=25°C)

Symbol	Parameter	N-Channel	P-Channel	Unit	
V _{DS}	Drain-Source Voltage	30	-30	V	
V _{GS}	Gate-Source Voltage	±20	±20	V	
I _D	Continuous Drain Current	T _C =25°C	6.5	-7	A
		T _C =70°C	5.4	-5.8	
I _{DM}	Pulsed Drain Current (note 2)	30	-30	A	
P _D	Maximum Power Dissipation	T _C =25°C	2	2	W
T _J , T _{STG}	Operating Junction and Storage Temperature Range	-55 to 150	-55 to 150	°C	
R _{θJA}	Thermal Resistance, Junction-to-Ambient (note 3)	62.5	62.5	°C/W	

Note 1: Stress beyond those listed under “absolute maximum ratings” may cause permanent damage to the device. Under “recommended operating conditions” the device operation is assured, but some particular parameter may not be achieved. The electrical characteristics table defines the operation range of the device, the electrical characteristics is assured on DC and AC voltage by the test program. For the parameters without minimum and maximum value in the EC table, the typical value defines the operation range, the accuracy is not guaranteed by spec.



BPM0306CG

30V Complementary MOSFET

Note 2: Repetitive Rating: Pulse width limited by maximum junction temperature.

Note 3: Surface Mounted on FR4 Board, $t \leq 10$ sec.

N-Channel Electrical Characteristics (note 4, 5) (Unless otherwise specified, $T_A=25^\circ\text{C}$)

Symbol	Parameter	Condition	Min	Typ	Max	Unit
Off Characteristics						
BV_{DSS}	Drain-Source Breakdown Voltage	$V_{GS}=0V, I_D=250\mu A$	30	33	-	V
I_{DSS}	Zero Gate Voltage Drain Current	$V_{DS}=30V, V_{GS}=0V$	-	-	1	μA
I_{GSS}	Gate-Body Leakage Current	$V_{GS}=\pm 20V, V_{DS}=0V$	-	-	± 100	nA
On Characteristics (Note 6)						
$V_{GS(th)}$	Gate Threshold Voltage	$V_{DS}=V_{GS}, I_D=250\mu A$	1	1.6	3	V
$R_{DS(on)}$	Drain-Source On-State Resistance	$V_{GS}=10V, I_D=6A$	-	20	30	m Ω
g_{FS}	Forward Transconductance	$V_{DS}=5V, I_D=6A$	15	-	-	S
Dynamic Characteristics (Note 7)						
C_{iss}	Input Capacitance	$V_{DS}=15V, V_{GS}=0V,$ $F=1.0MHz$	-	255	-	PF
C_{oss}	Output Capacitance		-	45	-	PF
C_{rss}	Reverse Transfer Capacitance		-	35	-	PF
Switching Characteristics (Note 7)						
$t_{d(on)}$	Turn-on Delay Time	$V_{DD}=15V, R_L=2.5\Omega$ $V_{GS}=10V, R_{GEN}=3\Omega$	-	4.5	-	nS
t_r	Turn-on Rise Time		-	2.5	-	nS
$t_{d(off)}$	Turn-Off Delay Time		-	14.5	-	nS
t_f	Turn-Off Fall Time		-	3.5	-	nS
Q_g	Total Gate Charge	$V_{DS}=15V, I_D=6A,$ $V_{GS}=10V$	-	13	-	nC
Q_{gs}	Gate-Source Charge		-	5.5	-	nC
Q_{gd}	Gate-Drain Charge		-	3.5	-	nC
Drain-Source Diode Characteristics						
V_{SD}	Diode Forward Voltage (Note 6)	$V_{GS}=0V, I_S=6A$	-	0.8	1.2	V



BPM0306CG

30V Complementary MOSFET

P-Channel Electrical Characteristics (note 4, 5) (Unless otherwise specified, $T_A=25^\circ\text{C}$)

Symbol	Parameter	Condition	Min	Typ	Max	Unit
Off Characteristics						
BV_{DSS}	Drain-Source Breakdown Voltage	$V_{GS}=0V, I_D=-250\mu A$	-30	-33	-	V
I_{DSS}	Zero Gate Voltage Drain Current	$V_{DS}=-30V, V_{GS}=0V$	-	-	-1	μA
I_{GSS}	Gate-Body Leakage Current	$V_{GS}=\pm 20V, V_{DS}=0V$	-	-	± 100	nA
On Characteristics (Note 6)						
$V_{GS(th)}$	Gate Threshold Voltage	$V_{DS}=V_{GS}, I_D=-250\mu A$	-1.5	-1.9	-2.5	V
$R_{DS(on)}$	Drain-Source On-State Resistance	$V_{GS}=-10V, I_D=-6.5A$	-	28	33	m Ω
g_{FS}	Forward Transconductance	$V_{DS}=-5V, I_D=-6.5A$	10	-	-	S
Dynamic Characteristics (Note 7)						
C_{iss}	Input Capacitance	$V_{DS}=-15V, V_{GS}=0V,$ $F=1.0MHz$	-	520	-	PF
C_{oss}	Output Capacitance		-	100	-	PF
C_{rss}	Reverse Transfer Capacitance		-	65	-	PF
Switching Characteristics (Note 7)						
$t_{d(on)}$	Turn-on Delay Time	$V_{DD}=-15V, R_L=2.3\Omega$ $V_{GS}=-10V, R_{GEN}=6\Omega$	-	7.5	-	nS
t_r	Turn-on Rise Time		-	5.5	-	nS
$t_{d(off)}$	Turn-Off Delay Time		-	19	-	nS
t_f	Turn-Off Fall Time		-	7	-	nS
Q_g	Total Gate Charge	$V_{DS}=-20V, I_D=-6.5A,$ $V_{GS}=-10V$	-	9.2	-	nC
Q_{gs}	Gate-Source Charge		-	1.6	-	nC
Q_{gd}	Gate-Drain Charge		-	2.2	-	nC
Drain-Source Diode Characteristics						
V_{SD}	Diode Forward Voltage (Note 6)	$V_{GS}=0V, I_S=-6.5A$	-	-0.8	-1.2	V

Note 4: Production testing of the chip is performed at 25°C .

Note 5: The maximum and minimum parameters specified are guaranteed by test, the typical value are guaranteed by design, characterization and statistical analysis.

Note 6: Pulse Test: Pulse Width $\leq 300\mu s$, Duty Cycle $\leq 2\%$.

Note 7: Guaranteed by design, not subject to production

N-Channel Typical Electrical and Thermal Characteristics Curves

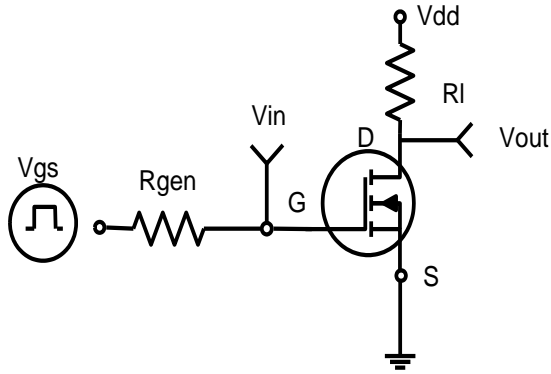

Figure 3. Switching Test Circuit

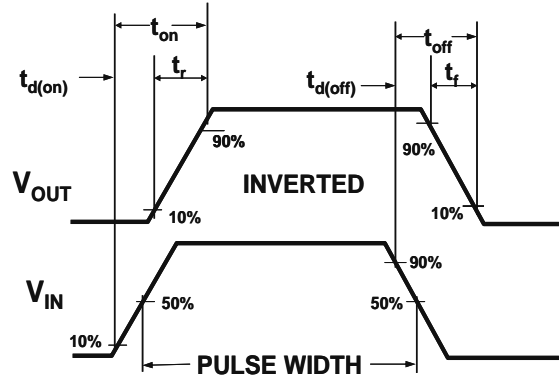

Figure 4. Switching Waveforms

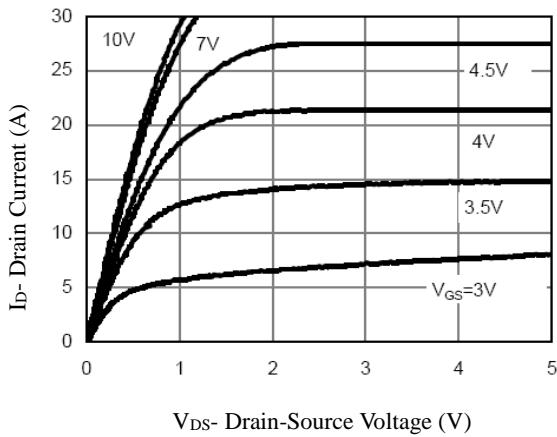

Figure 5. Output Characteristics

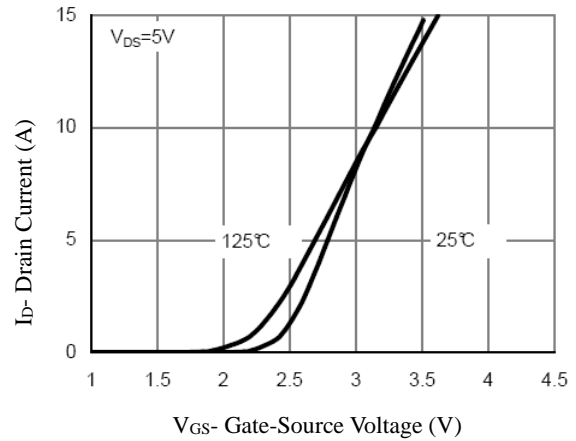

Figure 6. Transfer Characteristics

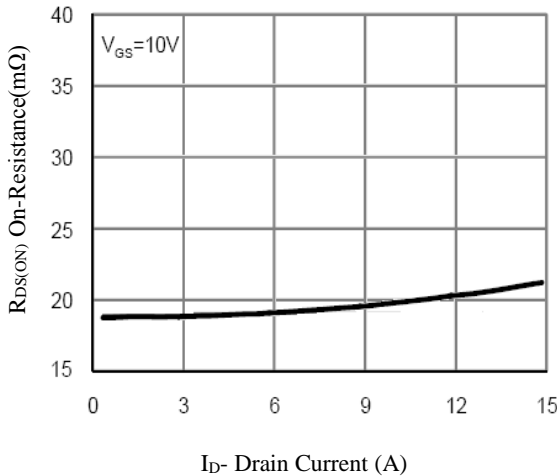

Figure 7. Drain-Source On-Resistance

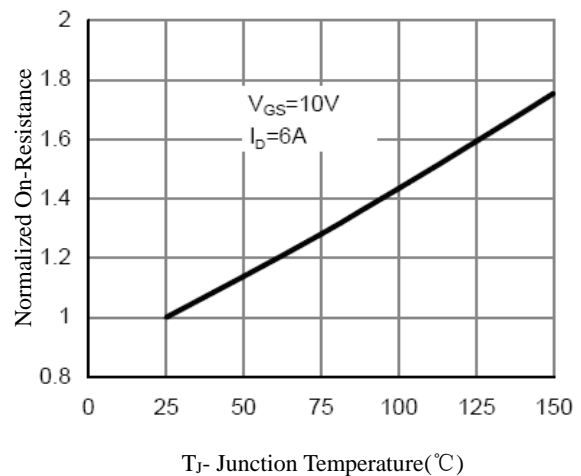

Figure 8. Drain-Source On-Resistance



BPM0306CG

30V Complementary MOSFET

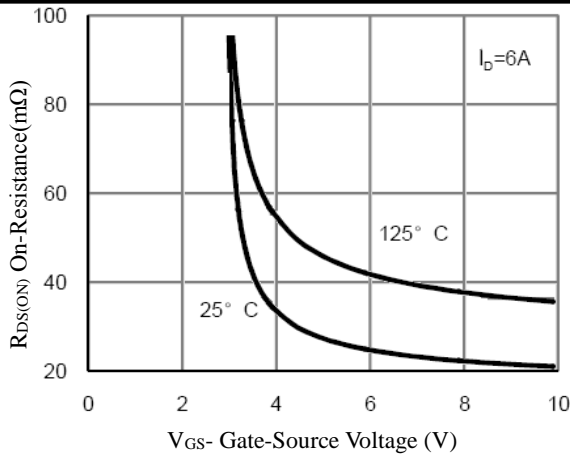

Figure 9. $R_{DS(ON)}$ vs V_{GS}

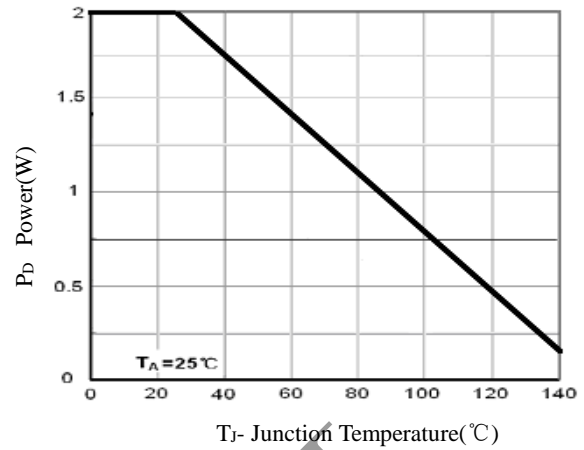

Figure 10. Power Dissipation

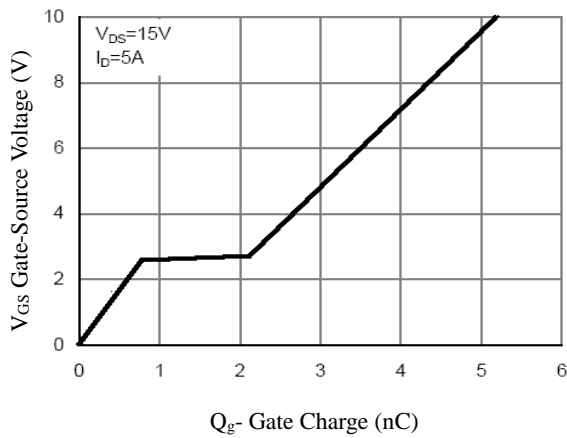

Figure 11 Gate Charge

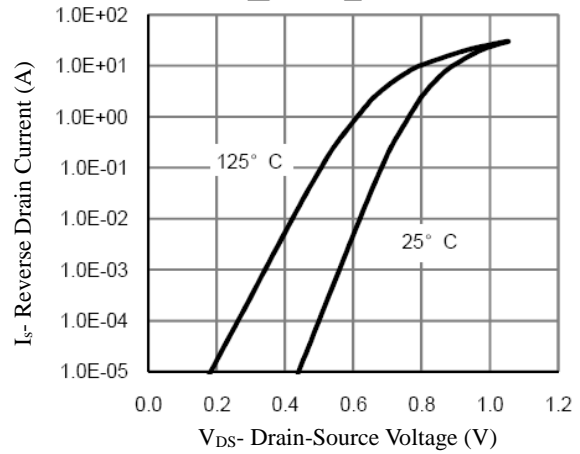

Figure 12. Source- Drain Diode Forward

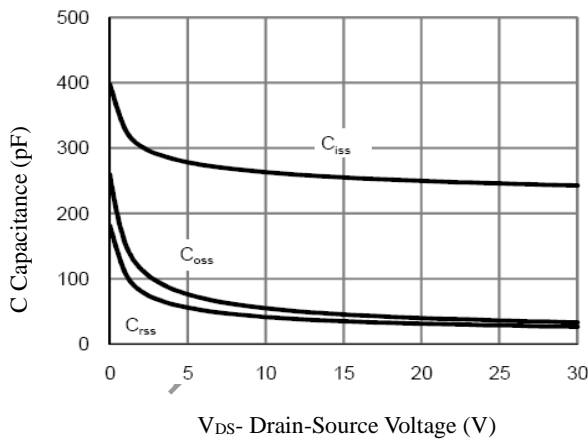

Figure 13. Capacitance vs V_{DS}

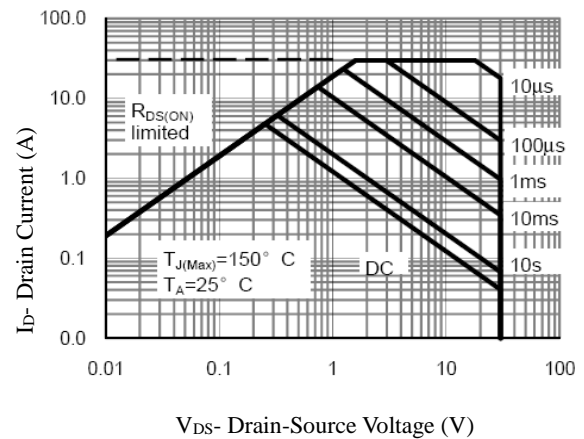

Figure 14. Safe Operation Area

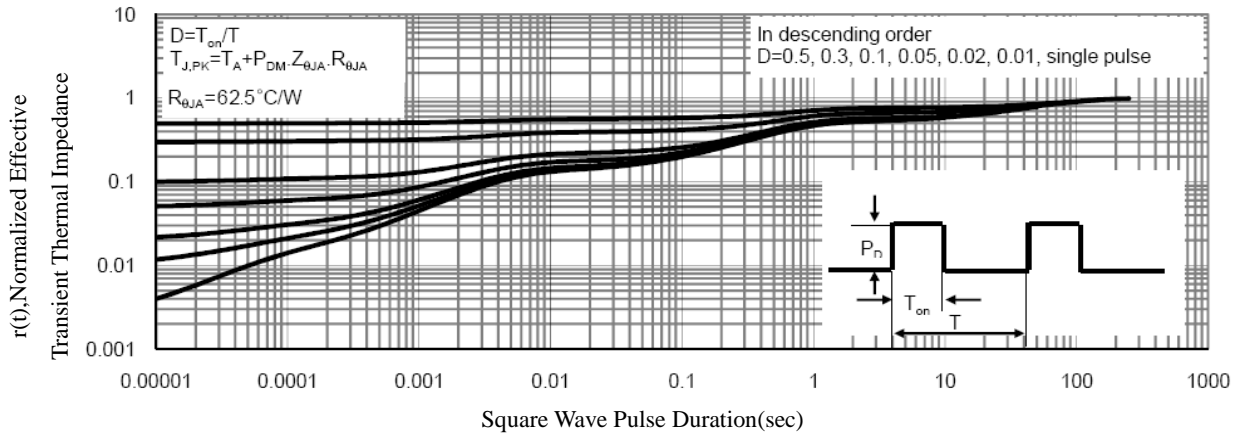

Figure 15. Normalized Maximum Transient Thermal Impedance

P-Channel Typical Electrical and Thermal Characteristics Curves

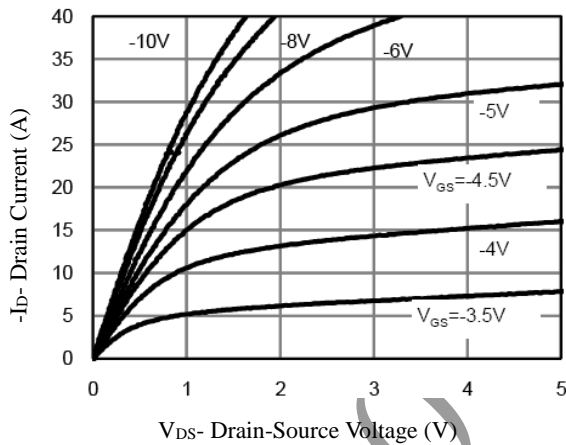

Figure 16. Output Characteristics

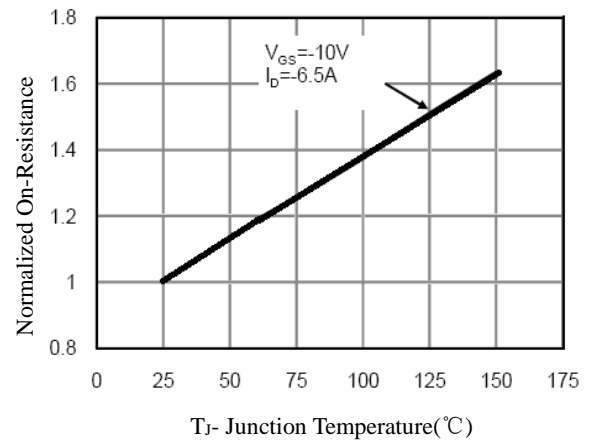

Figure 17. $R_{DS(ON)}$ -Junction Temperature

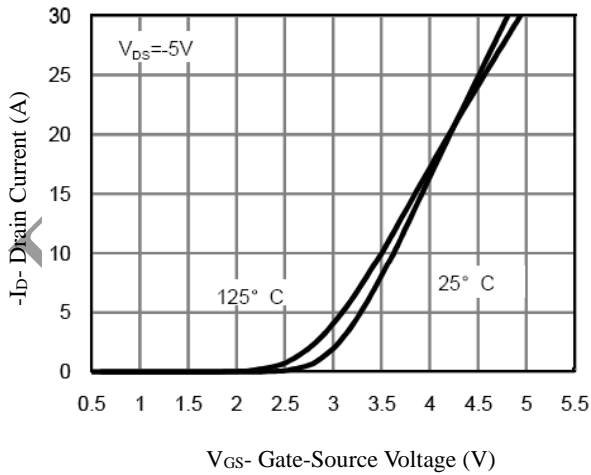

Figure 18. Transfer Characteristics

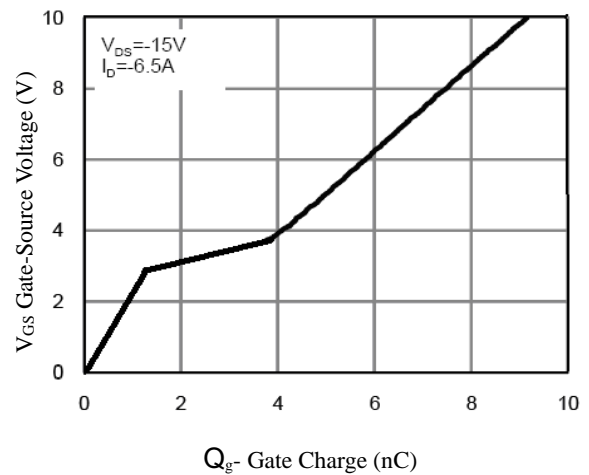

Figure 19. Gate Charge



BPM0306CG

30V Complementary MOSFET

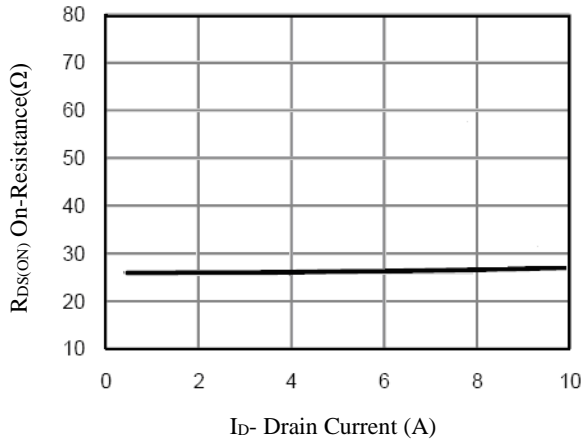

Figure 20. $R_{DS(ON)}$ - Drain Current

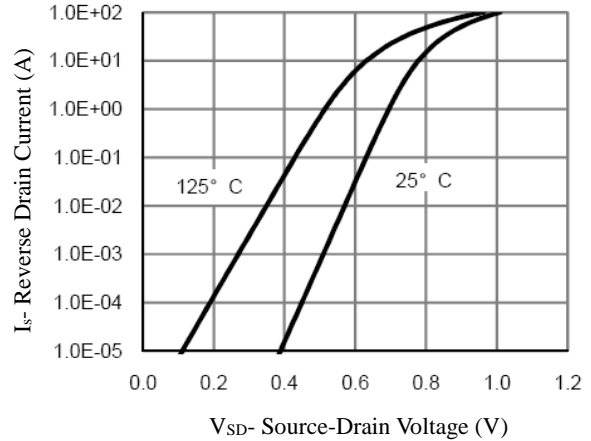

Figure 21. Source-Drain Diode Forward

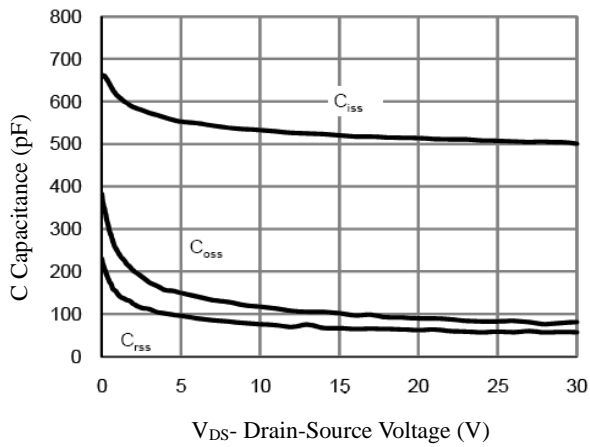

Figure 22. Capacitance vs V_{DS}

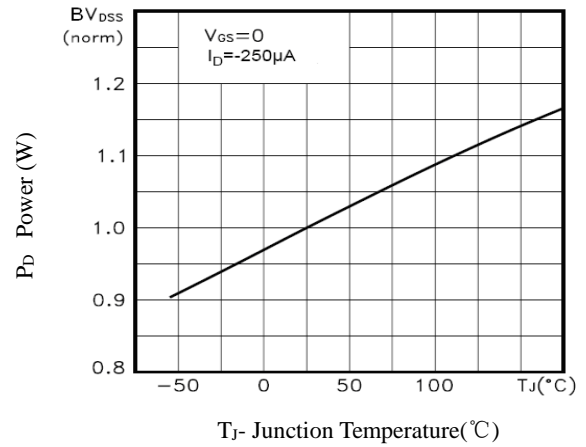

Figure 23. Power Dissipation

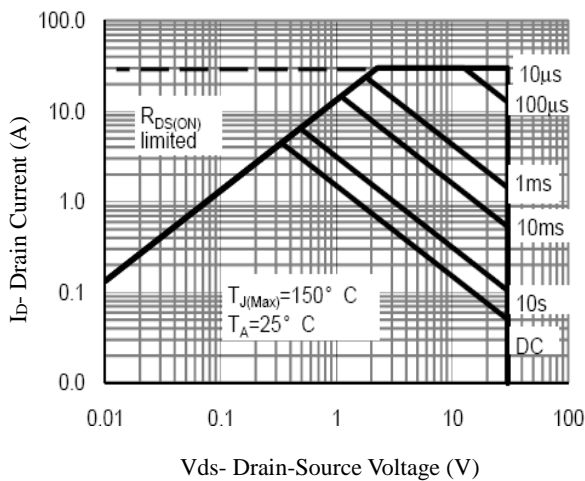

Figure 24. Safe Operation Area

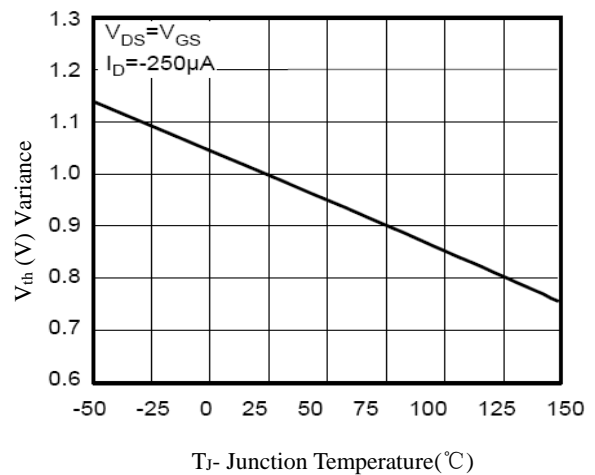

Figure 25. $V_{GS(th)}$ vs. Junction Temperature



BPM0306CG

30V Complementary MOSFET

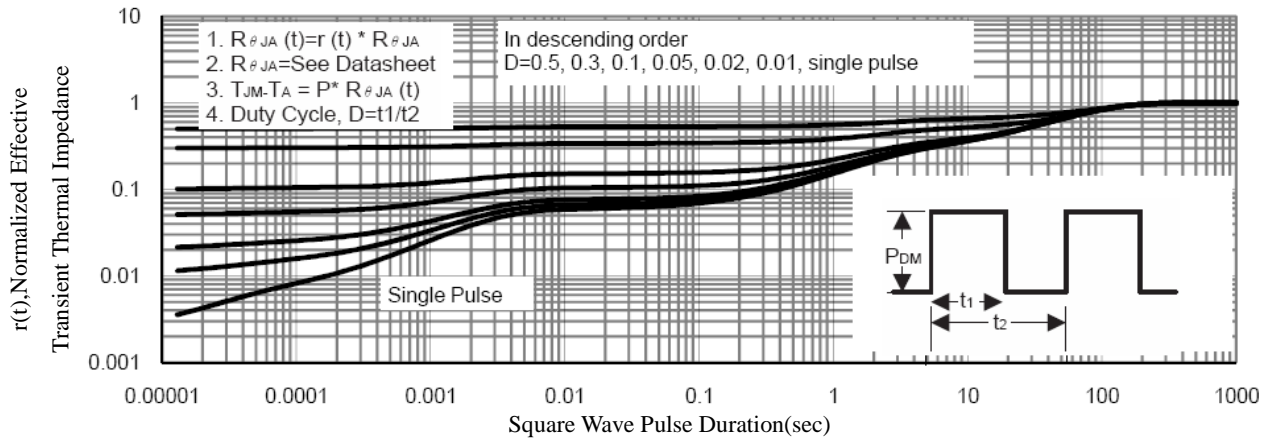

Figure 26. Normalized Maximum Transient Thermal Impedance

Physical Dimensions

