

General Description

The TD6817D is a current mode monolithic buck switching regulator. Operating with an input range of 2.5V-6V, the TD6817D delivers 2A of continuous output current with integrated P-Channel and N-Channel MOSFETs. The internal synchronous power switches provide high efficiency. At light loads, the regulator operate in low frequency to maintain high efficiency and low output ripples. Current mode control provides tight load transient response and cycle-by-cycle current limit.

The TD6817D guarantees robustness with hiccup output short-circuit protection, FB short-circuit protection, start-up current run-away protection, input under voltage lockout protection, hot-plug in protection, and thermal protection.

The TD6817D requires a minimum number of readily available standard external components. It is available in SOT23-5L packages.

Package Types

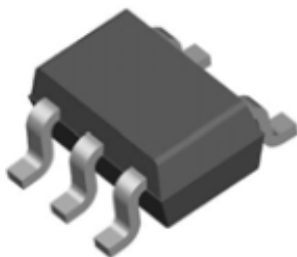

SOT23-5

Features

- 2.5V to 6V operating input range
- Up to 2A output current
- Up to 94% peak efficiency
- High efficiency (>85%) at light load
- Internal Soft-Start
- 1.5MHz switching frequency
- Input under voltage lockout
- Short circuit protection
- Thermal protection
- Hot-plug in protection
- Available in SOT23-5 PbFree Package

Application

- Set Top Boxes
- Storage Equipment
- GPU/DDR Power Supply
- Telecom/Networking Systems
- 5V or 3.3V Point of Load Conversion

Pin Configurations

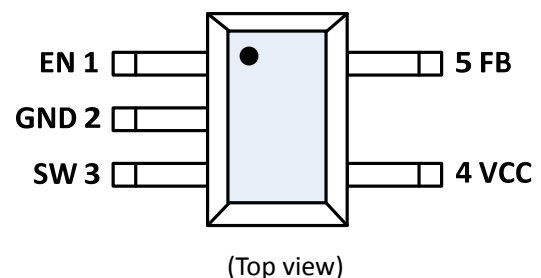

Pin Description

Pin Number	Pin Name	Description
1	EN	Chip Enable pin. Active high.
2	GND	Ground Pin.
3	SW	Switch Node Connection to Inductor. This pin connects to the drains of the internal main and synchronous power MOSFET switches.
4	VCC	Input voltage pin. VCC supplies power to the IC. Connect a 2.5V to 6V supply to VCC and bypass VCC to GND with a suitably large capacitor to eliminate noise on the input to the IC.
5	FB	Feedback Pin. Receives the feedback voltage from an external resistive divider across the output.

Ordering Information

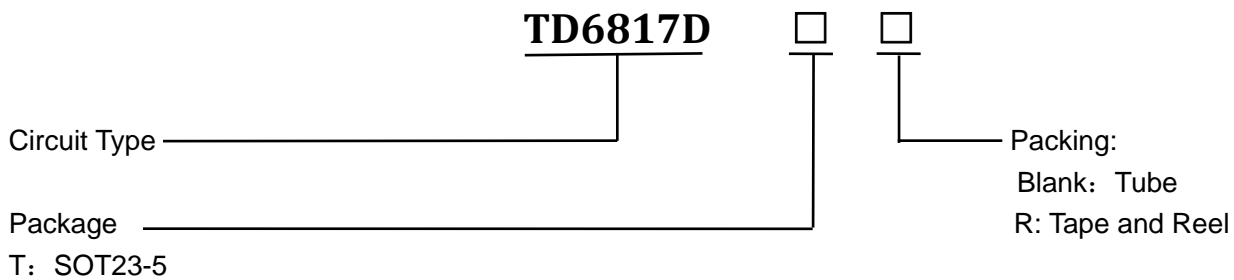

Function Block

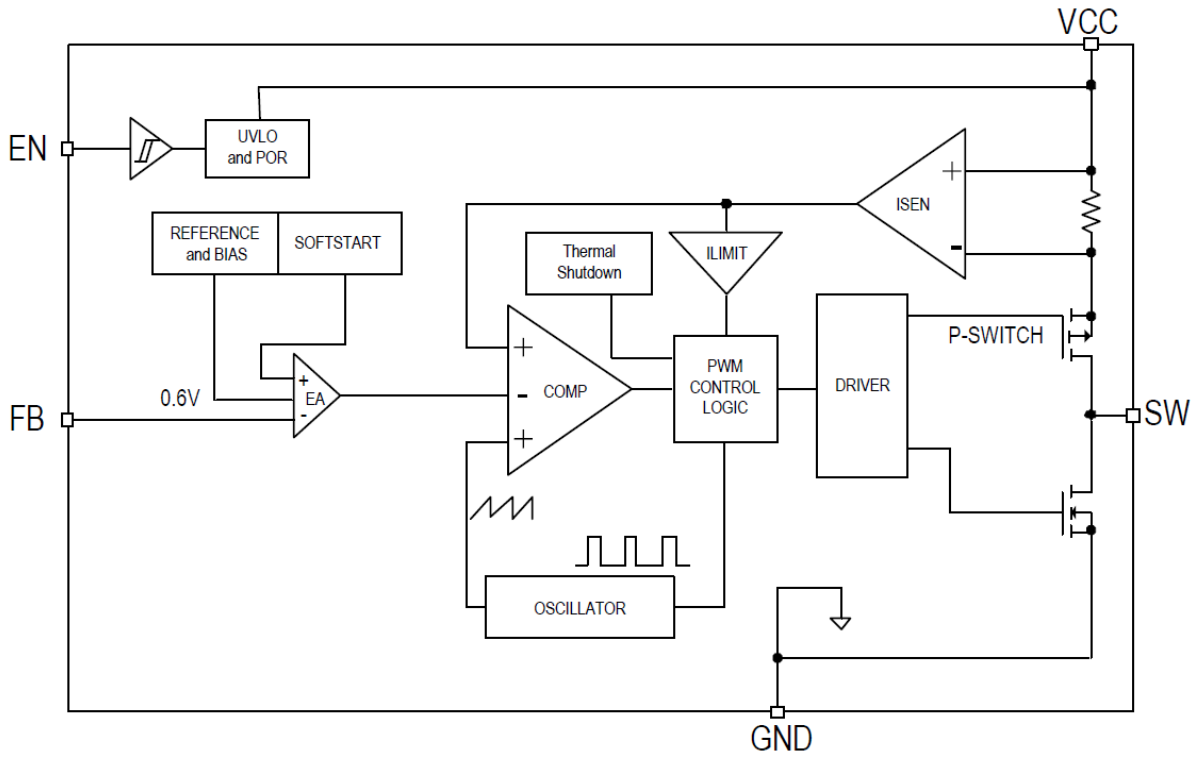

Figure1 Function Block Diagram of TD6817D

Typical Application Circuit

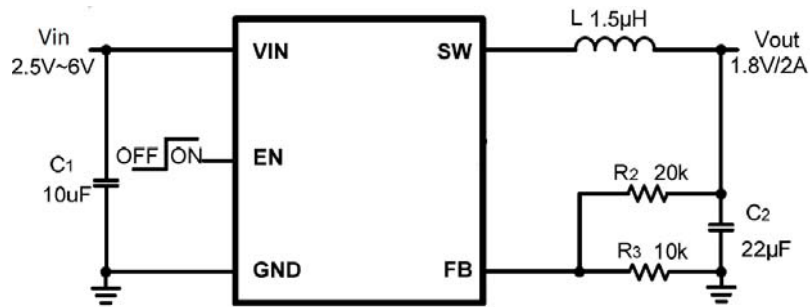

Figure2 $2.5V \leq Vin \leq 6V$ $Vout=1.8V$

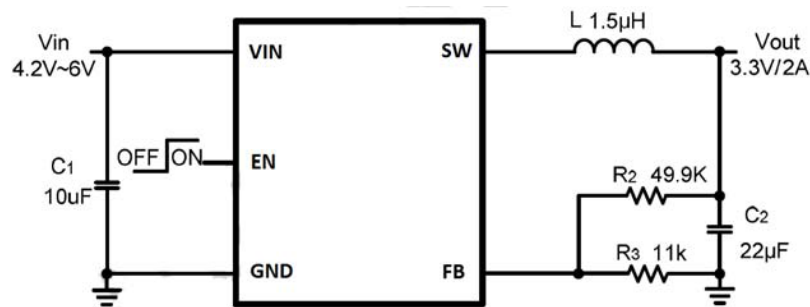

Figure3 $4.2V \leq Vin \leq 6V$ $Vout=3.3V$

Absolute Maximum Ratings (at $T_A=25^{\circ}\text{C}$)

Symbol	Parameter	Rating	Unit
	All Pins	-0.3 to 7.2	V
ESD	ESD Susceptibility (Human Body Model)	2K	V
T_{OP}	Operating Junction Temperature	-40 to 125	$^{\circ}\text{C}$
T_J	Junction Temperature	150	$^{\circ}\text{C}$
T_{STG}	Storage Temperature	-65 ~ 150	$^{\circ}\text{C}$
T_{SDR}	Maximum Lead Soldering Temperature (10 Seconds)	260	$^{\circ}\text{C}$

Electrical Characteristics

 Unless otherwise specified, these specifications apply over $V_{IN}=5\text{V}$, $V_{EN}=5\text{V}$, $T_A=25^{\circ}\text{C}$

Characteristics	Symbol	Conditions	Min	Typ	Max	Units
Input Voltage Range	V_{IN}		2.5	-	6	V
Input UVLO	UVLO	V_{IN} rising	2.25	2.4	2.55	V
V_{IN} Under Voltage Lockout Hysteresis	UVLO_HYST	V_{IN} falling	-	180	-	mV
Input OVLO	OVLO	V_{IN} rising	6.5	7	7.5	V
V_{IN} Over Voltage Protection Threshold	OVLO_HYST	V_{IN} falling	-	400	-	mV
Quiescent Current	I_Q	$V_{EN}=2\text{V}$, $V_{FB}=V_{REF} * 105\%$	-	40	60	μA
Shutdown Current	I_{SD}	$V_{EN}=0\text{V}$	-	0.1	1	μA
FB Pin Voltage	V_{FB}	$2.5\text{V} < V_{IN} < 6\text{V}$	0.582	0.6	0.618	V
PFET Leakage Current	I_{LEAK_P}	$V_{IN}=5.5\text{V}$, $V_{EN}=0\text{V}$, $V_{SW}=0\text{V}$	-	-	1	μA
NFET Leakage Current	I_{LEAK_N}	$V_{IN}=5.5\text{V}$, $V_{EN}=0\text{V}$, $V_{SW}=5.5\text{V}$	-	-	1	μA
PFET Current Limit	I_{LIM_TOP}	Duty Cycle=100%	-	2.4	-	A
EN Rising Threshold	V_{EN_TH}	V_{EN} rising, $\text{FB}=0.4\text{V}$	1.5	-	-	V
EN Falling Threshold	V_{EN_HYST}	V_{EN} falling, $\text{FB}=0.4\text{V}$	-	-	0.4	V
Switching Frequency	F_{OSC}	$I_{OUT}=2\text{A}$	1.2	1.5	1.8	MHz
Switching Maximum Duty _(Note)	D_{max}		-	91	-	%
Minimum On Time _(Note)	T_{ON_MIN}		-	100	-	ns
P-Switch $R_{DS(ON)}$ _(Note)	$R_{DS(ON)-P}$	$V_{IN}=3.6\text{V}$, $I_{SW}=200\text{mA}$	-	180	-	$\text{m}\Omega$
N-Switch $R_{DS(ON)}$ _(Note)	$R_{DS(ON)-N}$	$V_{IN}=3.6\text{V}$, $I_{SW}=200\text{mA}$	-	150	-	$\text{m}\Omega$
Thermal Shutdown _(Note)	T_{SD}		-	150	-	$^{\circ}\text{C}$
Thermal Shutdown Protection hysteresis _(Note)	T_{SH}		-	15	-	$^{\circ}\text{C}$

Note: Guaranteed by design.

Typical Operating Characteristics

$V_{in} = 5V$, $V_{out} = 1.8V$, $L = 1.5\mu H$, $C_{out} = 22\mu F$, $T_A = +25^\circ C$, unless otherwise noted

Startup through Enable

$V_{IN}=5V$, $V_{out}=1.8V$ $I_{out}=2A$ (Resistive load)

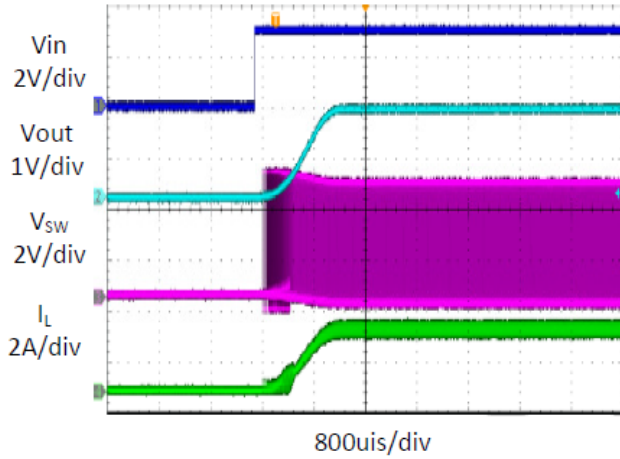

Shutdown through Enable

$V_{IN}=5V$, $V_{out}=1.8V$ $I_{out}=2A$ (Resistive load)

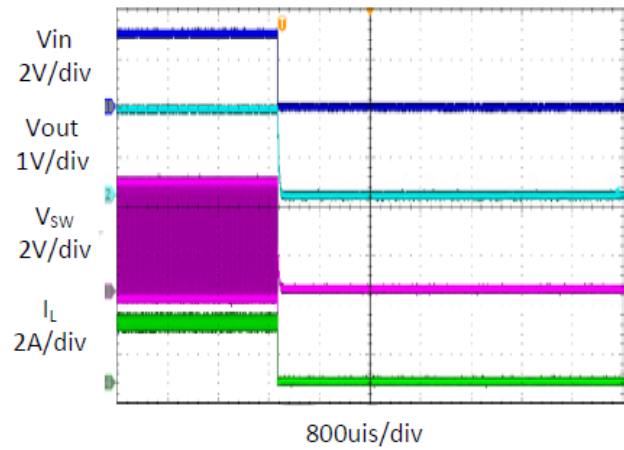

Heavy Load Operation

2A Load

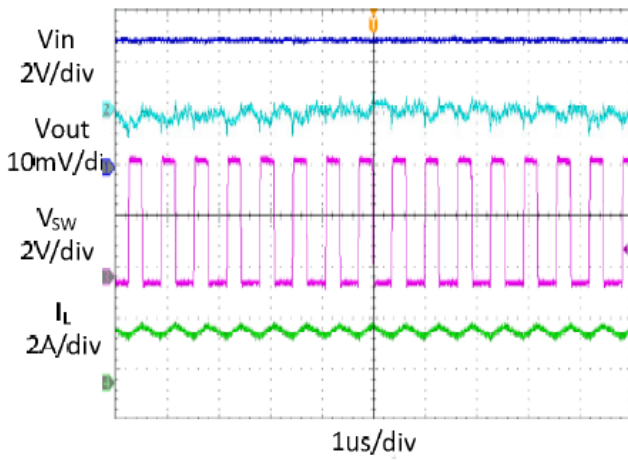

Medium Load Operation

1A Load

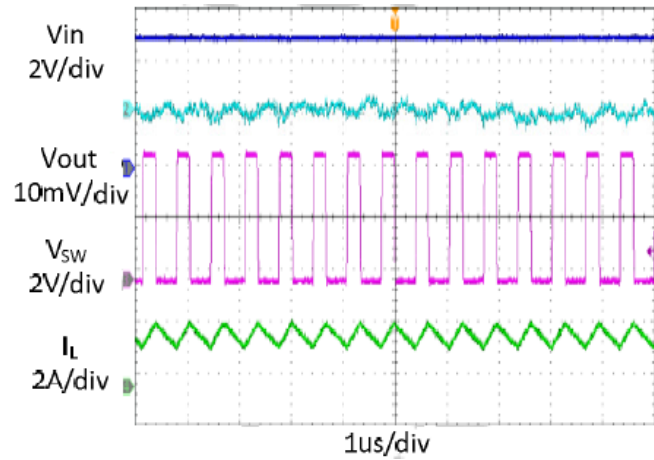

Typical Operating Characteristics(Cont.)

V_{in} = 5V, V_{out} = 1.8V, L = 1.5μH, C_{out} = 22μF, T_A = +25°C, unless otherwise noted

Light Load Operation

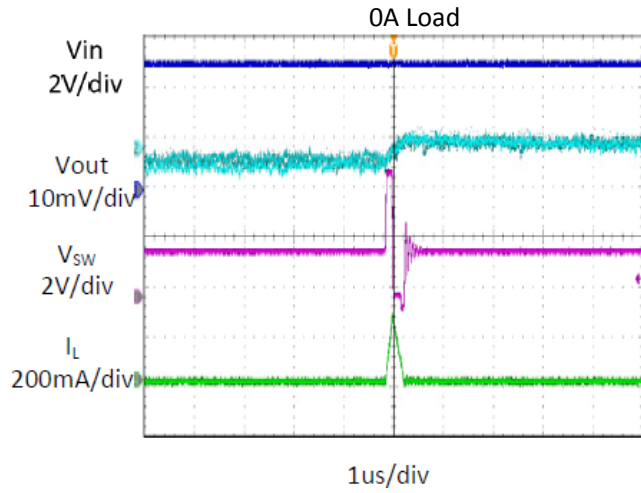

Load Transient

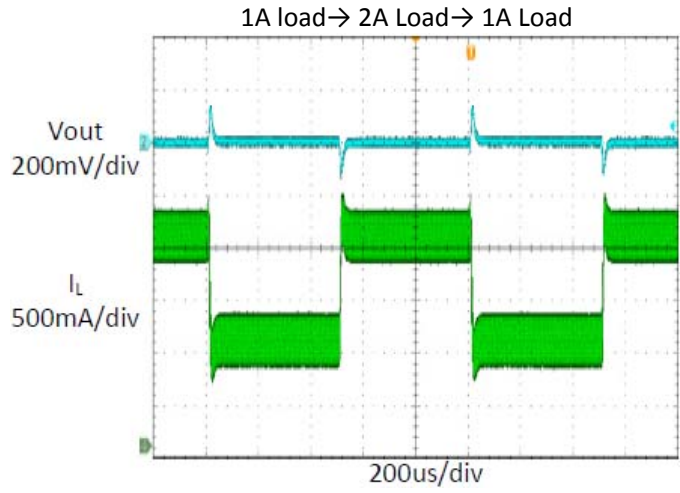

Short Circuit Protection

V_{IN}=5V, V_{out}=1.8V I_{out}=2A-Short

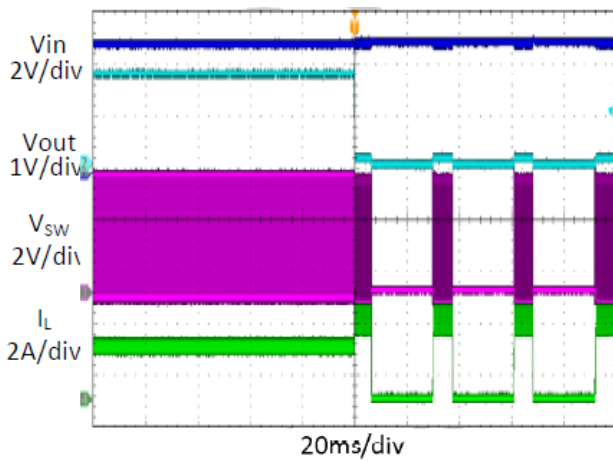

Short Circuit Protection

V_{IN}=5V, V_{out}=1.8V I_{out}=Short-2A

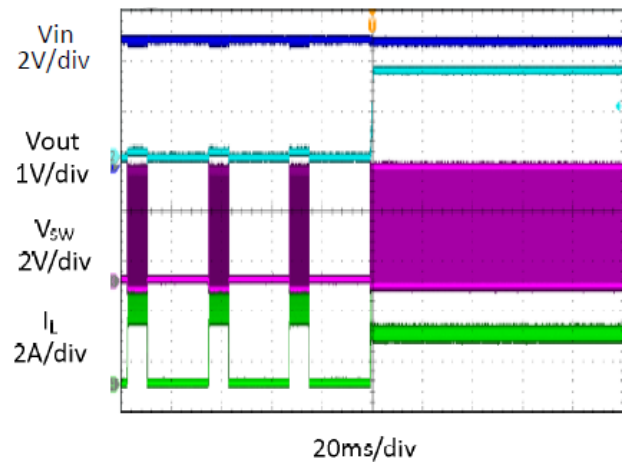

Typical Operating Characteristics(Cont.)

V_{in} = 5V, V_{out} = 1.8V, L = 1.5μH, C_{out} = 22μF, T_A = +25°C, unless otherwise noted

Quiescent Current Vs. Input Voltage

V_{IN}=2.5V ~ 6.5V, V_{EN}=2.5V, V_{FB}=0.8V

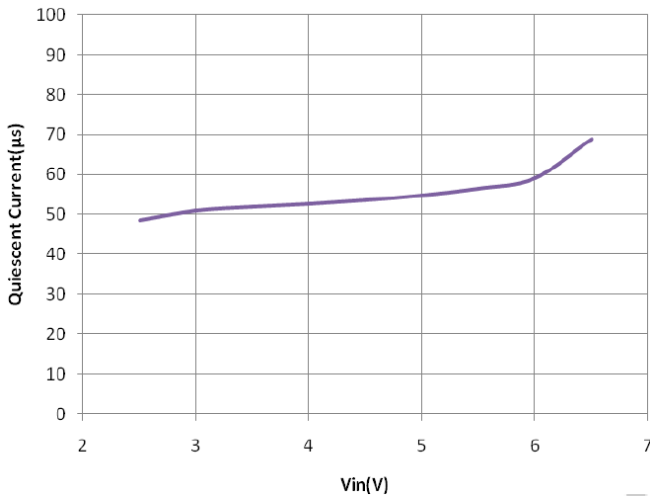

Shutdown Current Vs. Input Voltage

V_{IN}=2.5V ~ 6.5V, V_{EN}=0V, V_{FB}=0.5V

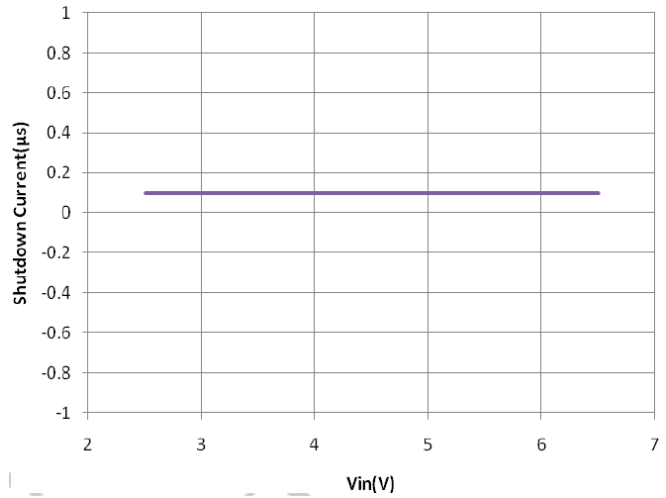

Efficiency @ Vout=3.3V

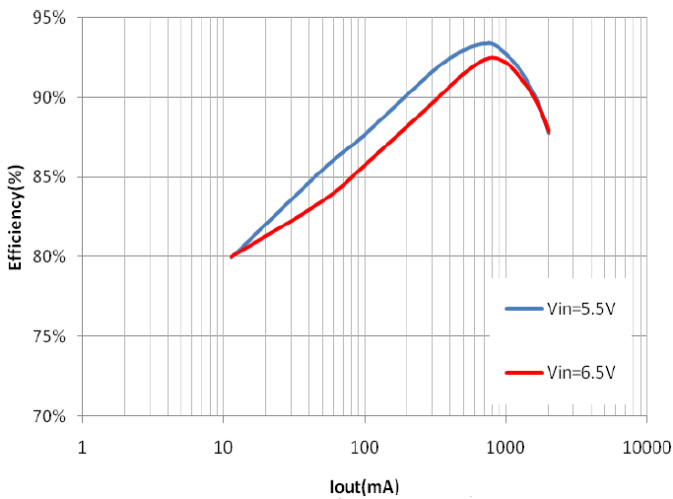

Efficiency @ Vout=2.5V

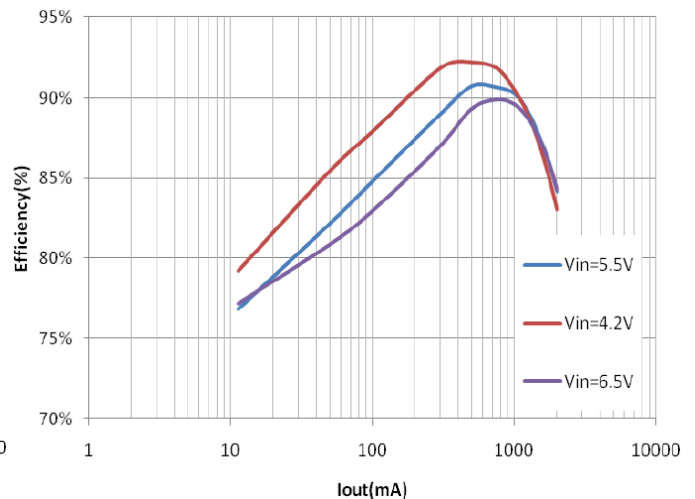

Efficiency @ Vout=1.8V

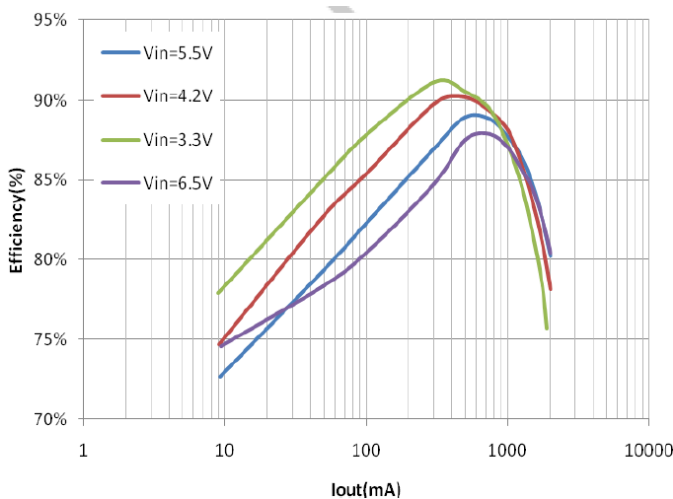

Load regulation @ Vout=1.8V

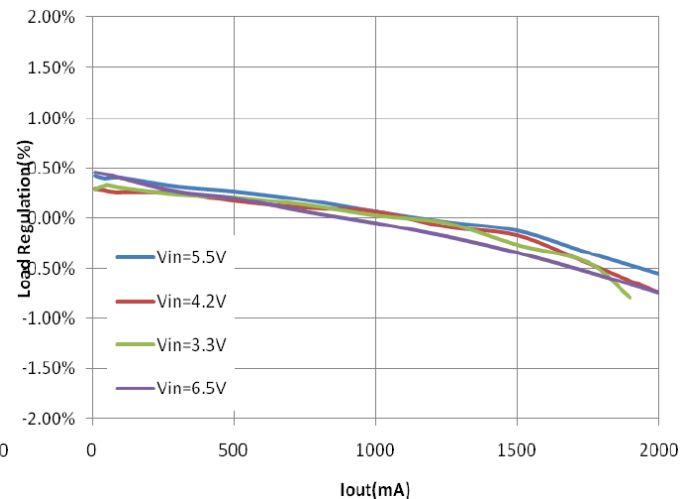

Function Description

The TD6817D is a synchronous, current-mode, step-down regulator. It regulates input voltages from 2.5V~6V down to an output voltage as low as 0.6V, and is capable of supplying up to 2A of load current.

Current-Mode Control

The TD6817D utilizes current-mode control to regulate the output voltage. The output voltage is measured at the FB pin through a resistive voltage divider and the error is amplified by the internal transconductance error amplifier. Output of the internal error amplifier is compared with the switch current measured internally to control the output current limit.

PFM Mode

The TD6817D operates in PFM mode at light load. In PFM mode, switch frequency is continuously controlled in proportion to the load current, i.e. switch frequency decreases when load current drops to boost power efficiency at light load by reducing switch-loss, while switch frequency increases when load current rises, minimizing output voltage ripples.

Shut-Down Mode

The TD6817D operates in shut-down mode when voltage at EN pin is driven below 0.4V. In shut-down mode, the entire regulator is off and the supply current consumed by the TD6817D drops below 1uA.

Power Switches

P-channel and N-channel MOSFET switches are integrated on the TD6817D to down convert the input voltage to the regulated output voltage.

Hot-Plug In Protection

If the Vin voltage exceeds 6.85V, IC will turn off power switch, entering over-voltage protection. It will remain in this state until Vin voltage is less than 6.5V.

Output Current Run-Away Protection

At start-up, due to the high voltage at input and low voltage at output, current inertia of the output inductance can be easily built up, resulting in a large start-up output current. A valley current limit is designed in the TD6817D so that only when output current drops below the valley current limit can the bottom power switch be turned off. By such control mechanism, the output current at start-up is well controlled.

Short Circuit Protection

When output is shorted to ground, the switching frequency is reduced to prevent the inductor current from increasing beyond PFET current limit. If short circuit condition holds for more than 1024 cycles, both PFET and NFET are forced off and can be enabled again after 8ms. This procedure is repeated as long as short circuit condition is not removed.

Thermal Protection

When the temperature of the TD6817D rises above 150°C, it is forced into thermal shut-down.

Only when core temperature drops below 135°C can the regulator becomes active again.

APPLICATION INFORMATION

Output Voltage Set

The output voltage is determined by the resistor divider connected at the FB pin, and the voltage ratio is:

$$V_{FB} = V_{OUT} * \frac{R_3}{R_2 + R_3}$$

where V_{FB} is the feedback voltage and V_{OUT} is the output voltage.

Choose R_3 around 10KΩ, and then R_2 can be calculated by:

$$R_2 = R_3 * \left(\frac{V_{OUT}}{0.6V} - 1 \right)$$

The following table lists the recommended values.

$V_{OUT}(V)$	$R_2(K\Omega)$	$R_3(K\Omega)$
1.2	10	10
1.8	20	10
2.5	31.6	10
3.3	49.9	11

Input Capacitor

The input capacitor is used to supply the AC input current to the step-down converter and maintaining the DC input voltage. The ripple current through the input capacitor can be calculated by:

$$I_{C1} = I_{LOAD} * \sqrt{\frac{V_{OUT}}{V_{IN}} * \left(1 - \frac{V_{OUT}}{V_{IN}} \right)}$$

where I_{LOAD} is the load current, V_{OUT} is the output voltage, V_{IN} is the input voltage.

Thus the input capacitor can be calculated by the following equation when the input ripple voltage is determined.

$$C_1 = \frac{I_{LOAD}}{f_s * \Delta V_{IN}} * \frac{V_{OUT}}{V_{IN}} * \left(1 - \frac{V_{OUT}}{V_{IN}} \right)$$

where C_1 is the input capacitance value, f_s is the switching frequency, ΔV_{IN} is the input ripple current.

The input capacitor can be electrolytic, tantalum or ceramic. To minimizing the potential noise, a small X5R or X7R ceramic capacitor, i.e. 0.1uF, should be placed as close to the IC as possible when using electrolytic capacitors.

A 10uF ceramic capacitor is recommended in typical application.

Output Capacitor

The output capacitor is required to maintain the DC output voltage, and the capacitance value determines the output ripple voltage. The output voltage ripple can be calculated by:

$$\Delta V_{OUT} = \frac{V_{OUT}}{f_s * L} * \left(1 - \frac{V_{OUT}}{V_{IN}} \right) * \left(R_{ESR} + \frac{1}{8f_s C_2} \right)$$

Where C_2 is the output capacitance value and R_{ESR} is the equivalent series resistance value of the output capacitor.

The output capacitor can be low ESR electrolytic, tantalum or ceramic, which lower ESR capacitors get lower output ripple voltage.

The output capacitors also affect the system stability and transient response, and a 22uF ceramic capacitor is recommended in typical application.

Inductor

The inductor is used to supply constant current to the output load, and the value determines the ripple current which affect the efficiency and the output voltage ripple. The ripple current is typically allowed to be 30% of the maximum switch current limit, thus the inductance value can be calculated by:

$$L = \frac{V_{OUT}}{f_s * \Delta I_L} * \left(1 - \frac{V_{OUT}}{V_{IN}} \right)$$

Where V_{IN} is the input voltage, V_{OUT} is the output voltage, f_s is the switching frequency, and ΔI_L is the peak-to-peak inductor ripple current.

PCB Layout Note

For minimum noise problem and best operating performance, the PCB is preferred to following the guidelines as reference.

1. Place the input decoupling capacitor as close to TD6817D (VIN pin and PGND) as possible to eliminate noise at the input pin. The loop area formed by input capacitor and GND must be minimized.
2. Put the feedback trace as far away from the inductor and noisy power traces as possible.
3. The ground plane on the PCB should be as large as possible for better heat dissipation.

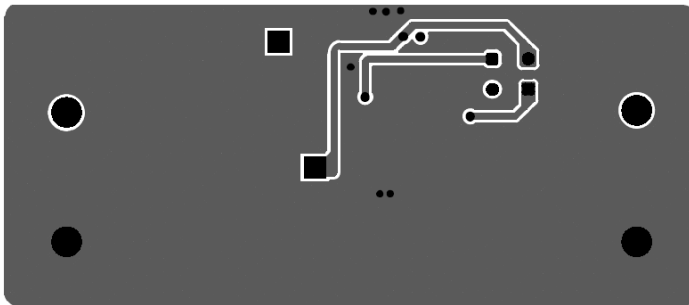
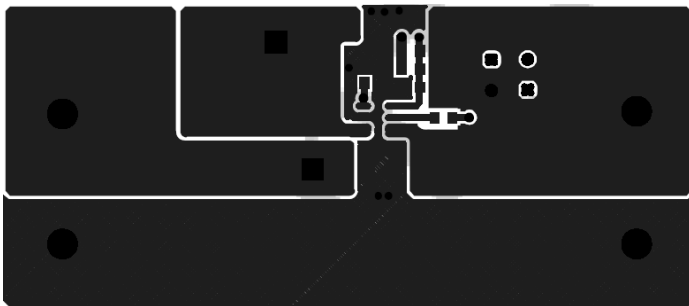
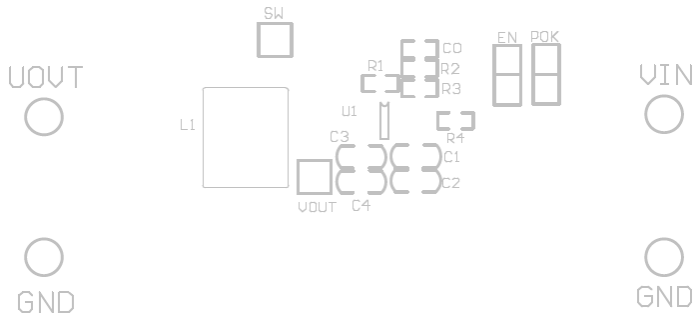

Package Information

SOT23-5 Package Outline Dimensions

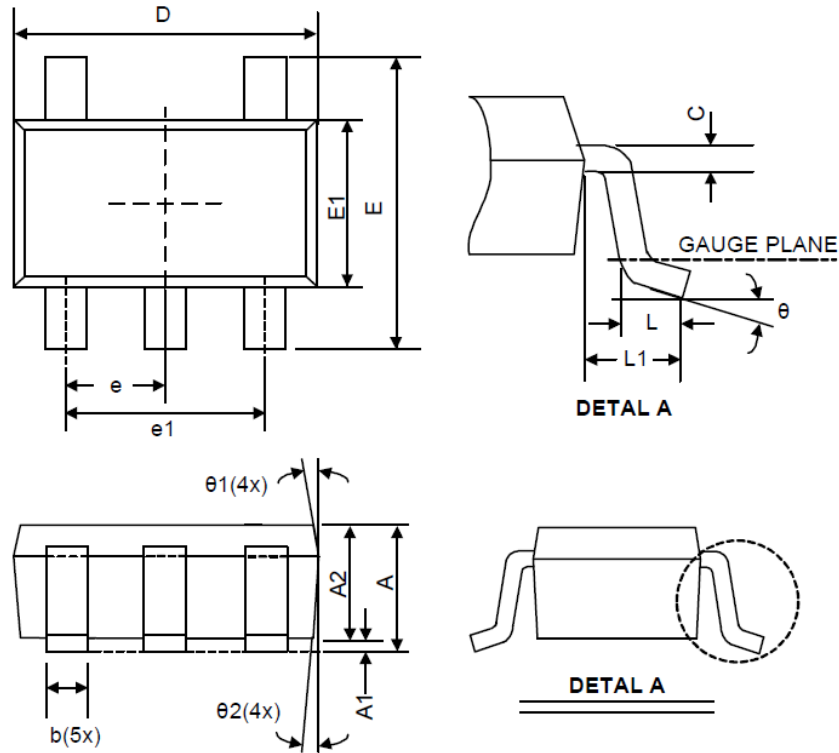

Symbol	Dimensions in Millimeters			Dimensions in Inches		
	Min.	Nom.	Max.	Min.	Nom.	Max.
A	1.05	-	1.35	0.041	-	0.053
A1	0.05	-	0.15	0.002	-	0.006
A2	1.00	1.10	1.20	0.039	0.043	0.047
b	0.30	-	0.50	0.012	-	0.020
C	0.08	-	0.22	0.003	-	0.009
D	2.80	2.90	3.00	0.110	0.114	0.118
E1	1.50	1.60	1.70	0.059	0.063	0.067
E	2.60	2.80	3.00	0.102	0.110	0.118
L	0.30	-	0.60	0.012	-	0.024
L1	0.50	0.60	0.70	0.020	0.024	0.028
e1	1.80	1.90	2.00	0.071	0.075	0.079
e	0.85	0.95	1.05	0.033	0.037	0.041
θ	0°	4°	8°	0°	4°	8°
θ1	5°	10°	15°	5°	10°	15°
θ2	5°	10°	15°	5°	10°	15°

Design Notes