

### »Features

- Excellent clamping capability
- Low leakage current
- Low capacitance
- High surge capability
- Glass passivated chip
- Epoxy resin package
- Built-in strain relief
- Will not fatigue
- RoHS Compliant
- Fast response time:  
typically less than 1.0ps from 0 Volts to  $V_{BR}$  min



SMC (DO-214AB)

### »Mechanical Characteristics

- Package: SMC plastic package.
- Lead Finish: Matte Tin
- Case Material: Epoxy Molding Compound.
- UL Flammability Classification Rating 94V-0
- Moisture Sensitivity: Level 1 per J-STD-020

### »Applications

- Telecom
- Computer
- Industrial electronic
- Consumer electronic

### »Electrical Parameters

Parameter	Definition
$C_J$	Junction Capacitance - typical capacitance measured with 0V or $V_R$ bias
$I_{PP}$	Peak Pulse Current - maximum rated peak impulse current
$V_C$	Clamping Voltage - Peak voltage measured across the suppressor at a specified $I_{ppm}$ (peak impulse current)
$V_{BR}$	Breakdown Voltage - Maximum voltage that flows through the TVS at a specified test current ( $I_T$ )
$I_R$	Leakage Current - maximum peak off-state current measured at $V_R$
$V_R$	Peak Off-state Voltage - maximum voltage that can be applied while maintaining off state

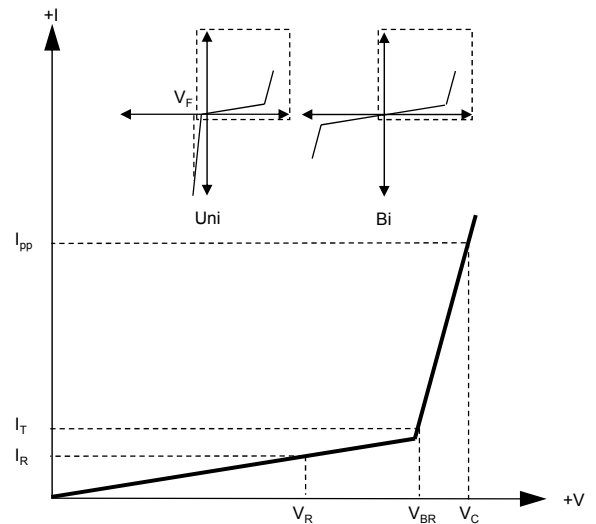

### »Summary of Packing Options

Package	Packing Description	Packing Quantity	Industry Standard
SMC	Tape/Reel, 13" reel	3000	EIA-481-1
	Tape/Reel, 7" reel	500	EIA-481-1

**»Absolute Maximum Ratings ( $T_A=25^{\circ}\text{C}$  unless otherwise noted)**

Parameter	Symbol	Value	Units	Remarks
Peak Pulse Power Dissipation	$P_{PPM}$	1500	W	(Note1)(Note2)
Steady State Power Dissipation	$P_D$	6.5	W	(Note3)
Peak Forward Surge Current	$I_{FSM}$	200	A	(Note4)
Maximum Instantaneous Forward Voltage at 100A	$V_{FM}$	3.5/5	V	(Note5)
Typical Thermal Resistance Junction to Lead	$R_{\theta JL}$	15	$^{\circ}\text{C}/\text{W}$	
Typical Thermal Resistance Junction to Ambient	$R_{\theta JA}$	75	$^{\circ}\text{C}/\text{W}$	
Operating Temperature Range	$T_J$	-55 to 150	$^{\circ}\text{C}$	
Storage Temperature Range	$T_{STG}$	-55 to 150	$^{\circ}\text{C}$	

Notes1: Non-repetitive current pulse , 10/1000us Waveform.

Notes2: Mounted on copper pad area of 8×8mm to each terminal.

Notes3: Infinite HeatSink at  $T_A=50^{\circ}\text{C}$

Notes4: Measured on 8.3ms single half sine wave or equivalent square wave, duty cycle=4 perminute maximum.

Notes5: For UnidirectionalOnly,  $V_{FM}<3.5\text{V}$  for  $V_{BR} \leq 200\text{V}$  and  $V_{FM}<5.0\text{V}$  for  $V_{BR} \geq 201\text{V}$ .

**»Electrical Characteristics ( $T_A=25^{\circ}\text{C}$  unless otherwise noted)**

Part Number (Uni)	Part Number (Bi)	Marking Code		Reverse Stand off Voltage $V_R$ (V)	Breakdown Voltage $V_{BR} @ I_T$ (V)		Test Current $I_T$ (mA)	Maximum Clamping Voltage $V_C @ I_{PP}$ (V)	Maximum Peak Pulse Current $I_{PP}$ (A)	Maximun Reverse Leakage $I_R @ V_R$ ( $\mu\text{A}$ )
		Uni	Bi		Min	Max				
SMCJ5.0A	SMCJ5.0CA	GDE	BDE	5	6.4	7	10	9.2	163	800
SMCJ6.0A	SMCJ6.0CA	GDG	BDG	6	6.67	7.37	10	10.3	145.7	800
SMCJ6.5A	SMCJ6.5CA	GDK	BDK	6.5	7.22	7.98	10	11.2	134	500
SMCJ7.0A	SMCJ7.0CA	GDM	BDM	7	7.78	8.6	10	12	125	200
SMCJ7.5A	SMCJ7.5CA	GDP	BDP	7.5	8.33	9.21	1	12.9	116.3	100
SMCJ8.0A	SMCJ8.0CA	GDR	BDR	8	8.89	9.83	1	13.6	110.3	50
SMCJ8.5A	SMCJ8.5CA	GDT	BDT	8.5	9.44	10.4	1	14.4	104.2	20
SMCJ9.0A	SMCJ9.0CA	GDV	BDV	9	10	11.1	1	15.4	97.4	10
SMCJ10A	SMCJ10CA	GDX	BDX	10	11.1	12.3	1	17	88.3	5
SMCJ11A	SMCJ11CA	GDZ	BDZ	11	12.2	13.5	1	18.2	82.5	1
SMCJ12A	SMCJ12CA	GEE	BEE	12	13.3	14.7	1	19.9	75.4	1
SMCJ13A	SMCJ13CA	GEG	BEG	13	14.4	15.9	1	21.5	69.8	1
SMCJ14A	SMCJ14CA	GEK	BEK	14	15.6	17.2	1	23.2	64.7	1
SMCJ15A	SMCJ15CA	GEM	BEM	15	16.7	18.5	1	24.4	61.5	1
SMCJ16A	SMCJ16CA	GEP	BEP	16	17.8	19.7	1	26	57.7	1
SMCJ17A	SMCJ17CA	GER	BER	17	18.9	20.9	1	27.6	54.4	1
SMCJ18A	SMCJ18CA	GET	BET	18	20	22.1	1	29.2	51.4	1
SMCJ20A	SMCJ20CA	GEV	BEV	20	22.2	24.5	1	32.4	46.3	1
SMCJ22A	SMCJ22CA	GEX	BEX	22	24.4	26.9	1	35.5	42.3	1
SMCJ24A	SMCJ24CA	GEZ	BEZ	24	26.7	29.5	1	38.9	38.6	1

**»Electrical Characteristics ( $T_A=25^{\circ}\text{C}$  unless otherwise noted)**

Part Number (Uni)	Part Number (Bi)	Marking Code		Reverse Stand off Voltage $V_R$ (V)	Breakdown Voltage $V_{BR} @ I_T$ (V)		Test Current $I_T$ (mA)	Maximum Clamping Voltage $V_C @ I_{PP}$ (V)	Maximum Peak Pulse Current $I_{PP}$ (A)	Maximun Reverse Leakage $I_R @ V_R$ ( $\mu\text{A}$ )
		Uni	Bi		Min	Max				
SMCJ26A	SMCJ26CA	GFE	BFE	26	28.9	31.9	1	42.1	35.7	1
SMCJ28A	SMCJ28CA	GFG	BFG	28	31.1	34.4	1	45.4	33.1	1
SMCJ30A	SMCJ30CA	GFK	BFK	30	33.3	36.8	1	48.4	31	1
SMCJ33A	SMCJ33CA	GFM	BFM	33	36.7	40.6	1	53.3	28.2	1
SMCJ36A	SMCJ36CA	GFP	BFP	36	40	44.2	1	58.1	25.9	1
SMCJ40A	SMCJ40CA	GFR	BFR	40	44.4	49.1	1	64.5	23.3	1
SMCJ43A	SMCJ43CA	GFT	BFT	43	47.8	52.8	1	69.4	21.7	1
SMCJ45A	SMCJ45CA	GFV	BFV	45	50	55.3	1	72.7	20.6	1
SMCJ48A	SMCJ48CA	GFX	BFX	48	53.3	58.9	1	77.4	19.4	1
SMCJ51A	SMCJ51CA	GFZ	BFZ	51	56.7	62.7	1	82.4	18.2	1
SMCJ54A	SMCJ54CA	GGE	BGE	54	60	66.3	1	87.1	17.3	1
SMCJ58A	SMCJ58CA	GGG	BGG	58	64.4	71.2	1	93.6	16.1	1
SMCJ60A	SMCJ60CA	GGK	BGK	60	66.7	73.7	1	96.8	15.5	1
SMCJ64A	SMCJ64CA	GGM	BGM	64	71.1	78.6	1	103	14.6	1
SMCJ70A	SMCJ70CA	GGP	BGP	70	77.8	86	1	113	13.3	1
SMCJ75A	SMCJ75CA	GGR	BGR	75	83.3	92.1	1	121	12.4	1
SMCJ78A	SMCJ78CA	GGT	BGT	78	86.7	95.8	1	126	11.9	1
SMCJ85A	SMCJ85CA	GGV	BGV	85	94.4	104	1	137	11	1
SMCJ90A	SMCJ90CA	GGX	BGX	90	100	111	1	146	10.3	1
SMCJ100A	SMCJ100CA	GGZ	BGZ	100	111	123	1	162	9.3	1
SMCJ110A	SMCJ110CA	GHE	BHE	110	122	135	1	177	8.5	1
SMCJ120A	SMCJ120CA	GHG	BHG	120	133	147	1	193	7.8	1
SMCJ130A	SMCJ130CA	GHK	BHK	130	144	159	1	209	7.2	1
SMCJ150A	SMCJ150CA	GHM	BHM	150	167	185	1	243	6.2	1
SMCJ160A	SMCJ160CA	GHP	BHP	160	178	197	1	259	5.8	1
SMCJ170A	SMCJ170CA	GHR	BHR	170	189	209	1	275	5.5	1
SMCJ180A	SMCJ180CA	GHT	BHT	180	201	222	1	292	5.1	1
SMCJ200A	SMCJ200CA	GHW	BHW	200	224	247	1	324	4.6	1
SMCJ220A	SMCJ220CA	GHX	BHX	220	246	272	1	356	4.2	1
SMCJ250A	SMCJ250CA	GHZ	BHZ	250	279	309	1	405	3.7	1
SMCJ300A	SMCJ300CA	GJE	BJE	300	335	371	1	486	3.1	1
SMCJ350A	SMCJ350CA	GJG	BJG	350	391	432	1	567	2.6	1
SMCJ400A	SMCJ400CA	GJK	BJK	400	447	494	1	648	2.3	1
SMCJ440A	SMCJ440CA	GJM	BJM	440	492	543	1	713	2.1	1

»Rating And Characteristic Curves ( $T_A=25^\circ\text{C}$  unless otherwise noted)

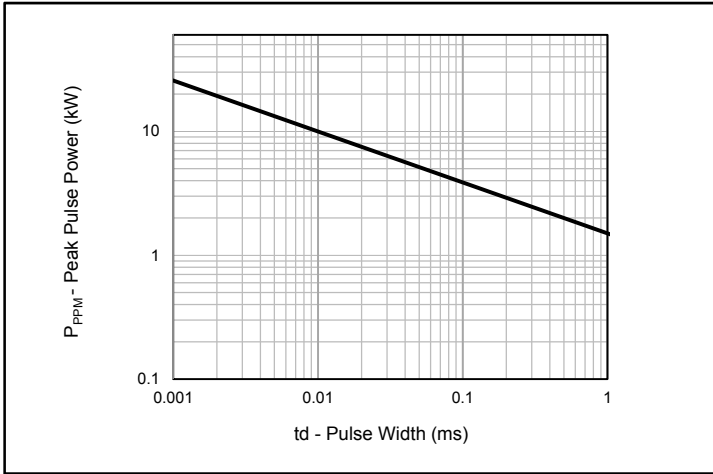

Fig.1 - Peak Pulse Power Rating



Fig.2 - Pulse Derating Curve

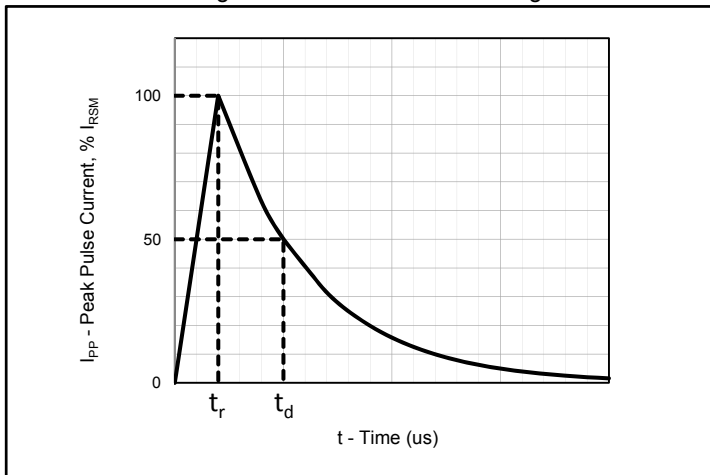

Fig.3 - Pulse Waveform

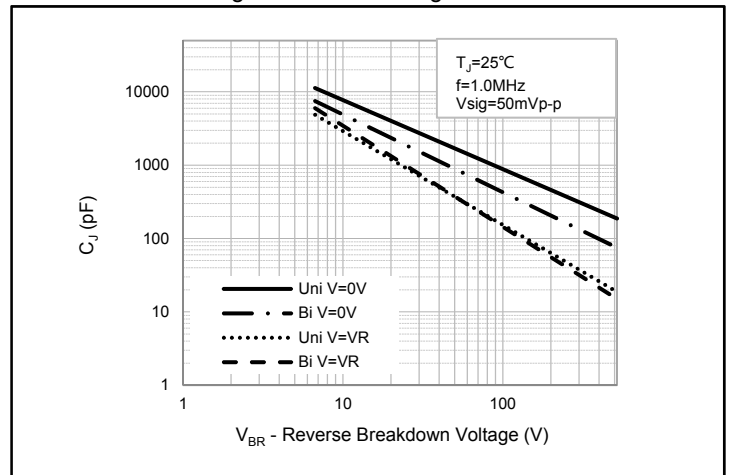

Fig.4 - Typical Junction Capacitance

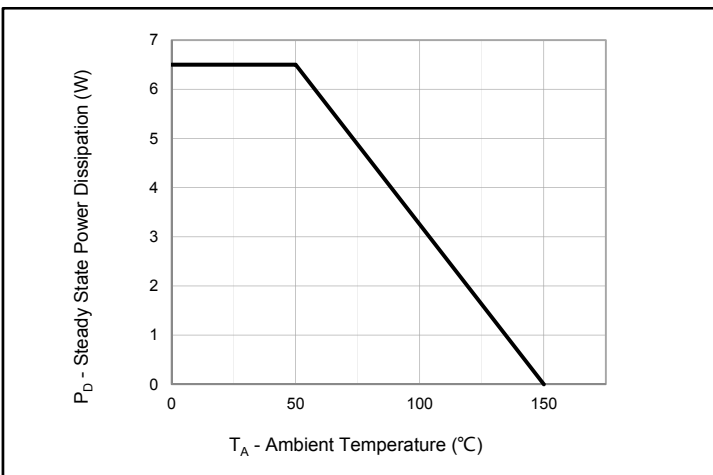

Fig.5 - Steady State Power Dissipation Derating Curve

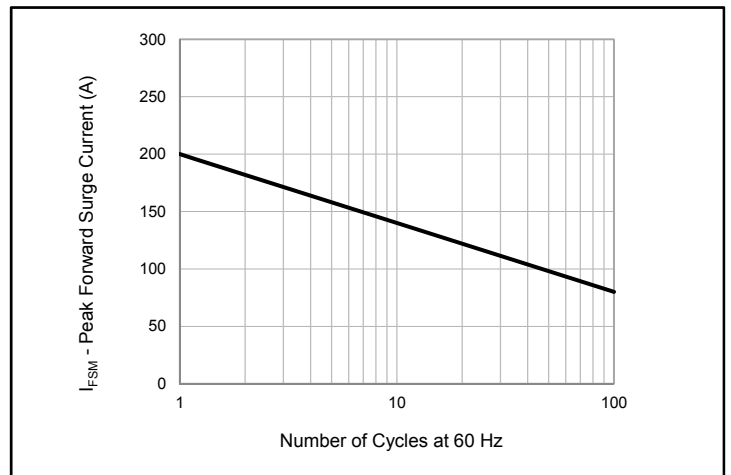
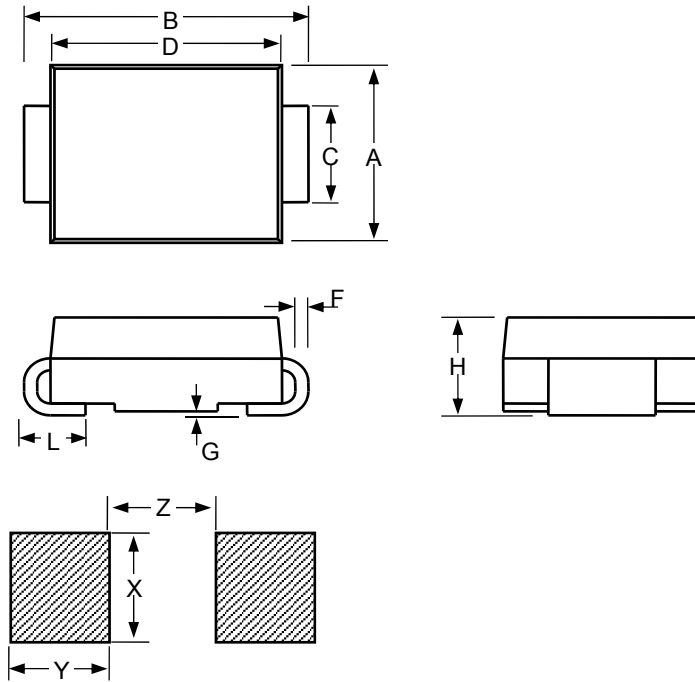

Fig.6 - Maximum Non-Repetitive Peak Forward Surge Current  
Uni-Directional Only

»Package Dimensions



SMCJ						
Dimension	Inches			Millimeters		
	MIN	NOM	MAX	MIN	NOM	MAX
A	0.22		0.245	5.59		6.22
B	0.305		0.32	7.75		8.13
C	0.114		0.126	2.9		3.2
D	0.26		0.28	6.6		7.11
F	0.006		0.012	0.15		0.305
G	-		0.008	-		0.203
H	0.087		0.11	2.2		2.8
L	0.03		0.06	0.76		1.52
X		0.15			3.82	
Y		0.119			3.03	
Z		0.151			3.84	

»Marking Information

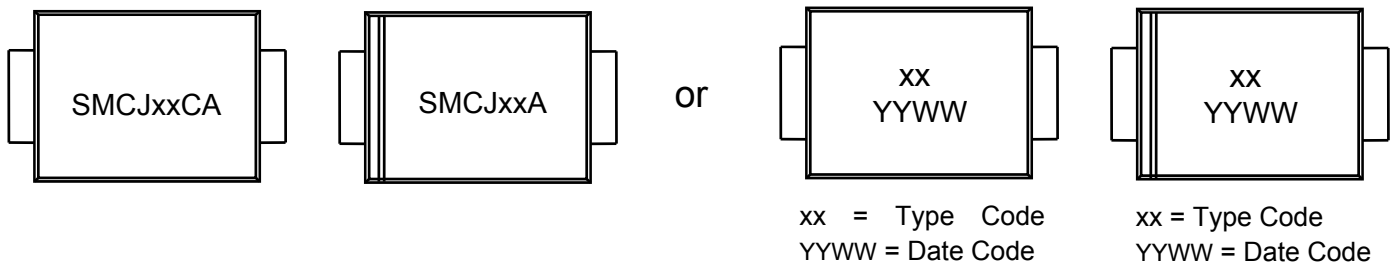

»Soldering Parameters



Reflow Condition		Lead-free assembly
Pre Heat	- Temperature Min ( $T_{s(min)}$ )	150°C
	- Temperature Max ( $T_{s(max)}$ )	200°C
	- Time (min to max) ( $t_s$ )	60 – 180 secs
Average ramp up rate (Liquidus Temp ( $T_L$ ) to peak)		3°C/second max
$T_{s(max)}$ to $T_L$ - Ramp-up Rate		3°C/second max
Reflow	- Temperature ( $T_L$ ) (Liquidus)	217°C
	- Time ( $t_L$ )	60 – 150 secs
Peak Temperature ( $T_P$ )		260 <sup>+0/-5</sup> °C
Time within 5°C of actual peak Temperature ( $t_p$ )		20 – 40 secs
Ramp-down Rate		6°C/second max
Time 25°C to peak Temperature (t)		8 minutes Max.
Do not exceed		260°C

»Tape and Reel Specification



Dimension	Inches			Millimeters		
	MIN	NOM	MAX	MIN	NOM	MAX
P		0.315			8	
P0		0.157			4	
W		0.63			16	
W1		0.646			16.4	
D1		7			177.8	
D2		13			330.2	