

LEFT SIDE VIEW

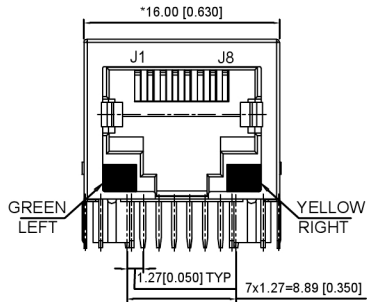

FRONT VIEW

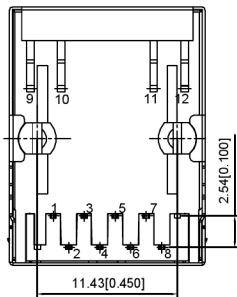

BOTTOM VIEW

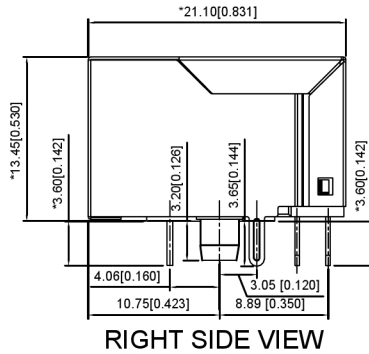

RIGHT SIDE VIEW

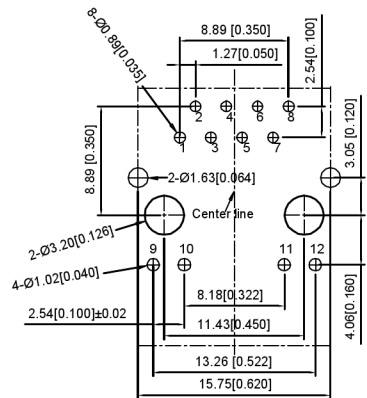

RECOMMENDED PCB LAYOUT VIEWED FROM COMPONENT SIDE

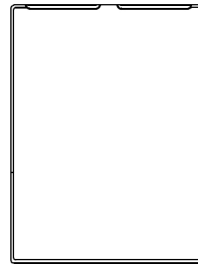

TOP VIEW

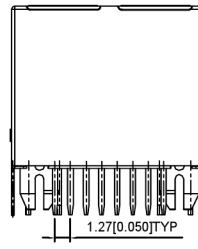

BACK VIEW

ELECTRICAL 电气:

- Turn ratio 匝数比: 1~2: J1~J2=1CT:1CT(±2%)
3~6: J3~J6=1CT:1CT(±2%)
- OCL 已占搭载量: 350uH Min. at 100KHz 100mV 8mA DC.
- Insertion Loss 插入损耗: -1.0 dB Max 1~100MHz
- Return loss 回程损耗: -20dB Min 1~10MHz
-16dB Min 10~30MHz
-12dB Min 30~60MHz
-10dB Min 60~80MHz
- Cross talk 声道串扰: -40dB Min 1~30MHz;
-35dB Min 30~60MHz;
-30dB Min 60~100MHz;
- CMR 共模抑制: -30dB Min 1~100MHz;
- Hi-Pot 耐压测试: 1500V AC & 2250V DC 6S
1mA PRI TO SEC

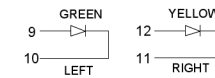
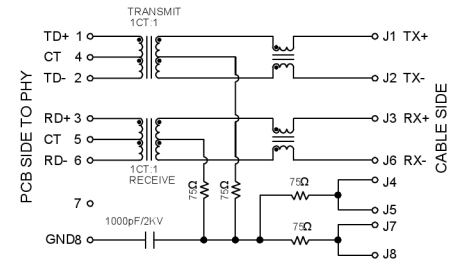

LED Specification

Standard LED Color	LED Wavelength	Forward(A)	Forward(V)
Green	568nm	20mA	1.85~2.45V
Yellow	585nm	20mA	1.7~2.2V

XKB Connectivity

MATERIAL 材料:

- HOUSING 外壳: PBT, UL94V-0, BLACK.
- TERMINALS BRACKET 端子支架: PBT, UL94V-0, BLACK.
- SHIELD 保护物: C2680, T=0.20MM, NICKEL PLATING ON ALL AREA.
- TERMINAL 端子: PHOSPHOR BRONZE C5210, T=0.35MM, GOLD PLATING ON CONTACT AREA.

MECHANICAL 机械:

- DURABILITY 耐用性: 750 CYCLES MIN.
- MATING FORCE 配合力: 23N MAX.
- OPERATING TEMPERATURE 工作温度: -40°C~+85°C.
- STORAGE TEMPERATURE 储存温度: -40°C~+85°C.
- ALL CRITICAL DIMENSIONS WITH "M"

广东星坤科技股份有限公司

ΔX	日期
ΔX	日期
ΔX	日期
MARK	DESCRIPTION

文件工程章

REVISIONS	DATE	REVISED	APPROVED	UNSPECIFIED TOLERANCES
ANGLAR				±5°
L ≤ 4				±0.2
4 < L ≤ 16				±0.3
16 < L ≤ 63				±0.4
L > 63				±0.5

DSND	SCALE: N/A	MODEL TYPE:	RJ JACK
DWN	VIEW:	PART NO.:	
CHKD	UNIT: mm/in	DWG NO.:	X01AB002AA2DD
APPD	SIZE: A4	WEIGHT	SHEET
XKB INDUSTRIAL PRECISION CO., LIMITED		1/1	REVISIOI
			A0