

ROHS

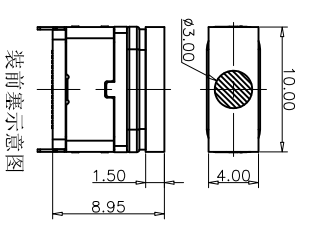

装前塞示意图

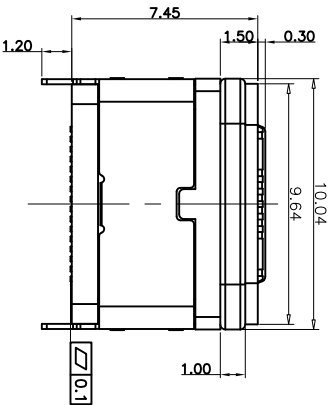
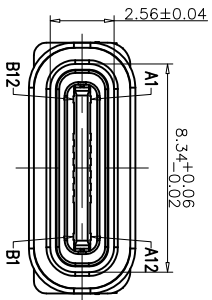
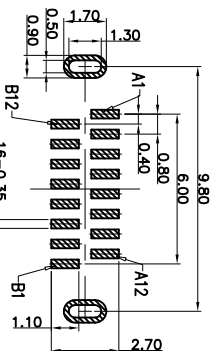

RECOMMEND P.C.B LAYOUT  
TOLERANCE UNSPECIFIED ±0.05mm

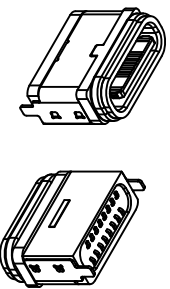
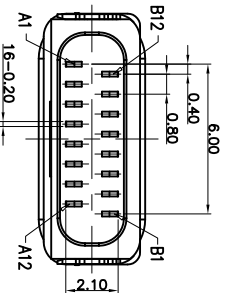
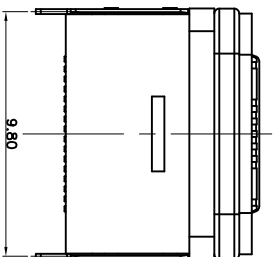
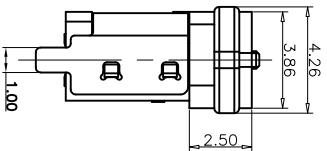

MAPX

MODIFICATION

DRW

DATE

- NOTES:
- SPECIFICATION:
- CURRENT RATING: 3.0 A
  - VOLTAGE RATING: 3.0 V
  - VBUS & GND PINS AND OTHER PINS: 40mQ/PIN MAX SHIELD: 50mQ/MAX
  - LCR MAX: CHANGE OF ALL PINS: 102m
  - INSULATION RESISTANCE: 100MΩ MIN
  - DIELECTRIC WITHSTAND VOLTAGE: AC 100V FOR 1MINUTE
  - INSERTION FORCE: 0.5~2.0kgf
  - UNMATING FORCE: 0.8~2.0kgf
  - DURABILITY: 10000 CYCLES
  - OPERATING TEMPERATURE: -35°C~+85°C
  - THE PEAK TEMPERATURE ON THE BOARD SHALL BE MAINTAINED FOR 10 SECONDS AT 230°C
  - WATERPROOF: IP-X7.

USB TYPE C PIN ASSIGNMENTS

PIN NUMBER	SIGNAL NAME	PIN NUMBER	SIGNAL NAME
A1	GND	B12	GND
A4	VBUS	B9	VBUS
A5	CC1	B8	SR12
A6	DP1	B7	DM2
A7	DM1	B6	DP2
A8	SR11	B5	CC2
A9	VBUS	B4	VBUS
A12	GND	B1	GND

TABLE:

NO	PART	QTY	Material
1	PLASTIC SHELL	1	PA UL94 V-0 BLACK
2	CONTACT	16	C7025,TIN80U"/Au3u"/Ni30u"PLATED
3	MID PLATE	1	SUS301,NO PLATING
4	HOUSING	1	LCP UL94 V-0 BLACK
5	SHIELDING PLATE	1	SUS,NI PLATED
6	WATERPROOF RING	1	SILICONE UL94 V-0 BLACK
7	CAP	1	LCP UL94 V-0 BLACK

产品图  
公差一览表

PRODUCT CHART DWG	TOLERANCE UNLESS OTHERWISE
X.	±0.25 X.
X.	±0.20 X.
.XX	±0.05 .XX
.XXX	±0.02 .XXX
	±5.°
	±2.°
	±1.°
	±0.5°

深圳市精拓金电子有限公司  
Shenzhen Jing Tuo Jin Electronics Co., Ltd.

单位	MM	制图	YANG	制图料号	918-468K2027Y10000
UNITS	MM	DRAWING	YANG	PRODUCT PART NO.	918-468K2027Y10000
比例	1:1	审核	郭治富	产品名称	TYPE-C3_1防水母座立式L=7.45
SCALE	1:1	CHD	郭治富	产品NO	两脚插板,CP黑胶双排SUITABLE PIN
日期	2020-05-22	核准	黄国荣	角法	VER
DATE	2020-05-22	APPD	黄国荣	版本	AO

TYPE C 16P 防水母座立式贴板 L=7.45mm (U型全塑款)  
胶芯: LCP/黑色/无卤; 端子: 高导电/镀半金锡3U";  
中钢片: 不锈钢/  
素材: U型胶壳: LCP/黑色/无卤;  
护脚外壳: 不锈钢/镀锌; 环保要求: ROHS+REACH (0.7K/卷)