

## Transient Voltage Suppressors (TVS) Data Sheet

### Features

- For surface mounted applications in order to optimize board space
- Low profile package
- Built-in strain relief
- Glass passivated junction
- Low inductance
- Excellent clamping capability
- 5000W peak pulse power capability at 10/1000μs waveform, repetition rate (duty cycle): 0.01%
- Fast response time
- Typical  $I_R$  less than 2μA above 22V
- High Temperature soldering: 260°C/10 seconds at terminals
- Plastic package has underwriters laboratory flammability 94V-0
- Meets MSL level 1, per J-STD-020
- Safety certification: UL: E244458
- AEC-Q101 qualified
- IEC61000-4-2 ESD 30KV Air, 30KV contact compliance



### Mechanical Data

- Case: JEDEC DO-214AB. Molded plastic over glass passivated junction
- Terminal: Tin plated, solderable per MIL-STD-750, Method 2026
- Polarity: Color band denotes cathode except bi-directional models
- Standard Packaging: 16mm tape (EIA STD RS-481)
- Weight: 0.30g

### Applications

- I/O interface
- AC/DC power supply
- Low frequency signal transmission line (RS232, RS485, etc.)

### Maximum Ratings and Characteristics

Ratings at 25° C ambient temperature unless otherwise specified.

Rating	Symbol	Value	Units
Peak pulse power dissipation at 10/1000μs waveform (Note1, Note2, Fig.1)	$P_{PPM}$	Minimum 5000	Watts
Peak pulse current of at 10/1000μs waveform (Note 1, Fig.3)	$I_{PPM}$	See Table	Amps
Steady state power dissipation at $T_A=50^\circ\text{C}$ (Fig.5)	$P_{M(AV)}$	6.5	Watts
Peak forward surge current, 8.3ms single half sine-wave superimposed on rated load, (JEDEC Method) (Note3, Fig.6)	$I_{FSM}$	300	Amps
Operating junction and Storage Temperature Range.	$T_J, T_{STG}$	-55 to +150	°C
Typical thermal resistance junction to lead	$R_{\theta JL}$	15	°C/W
Typical thermal resistance junction to ambient	$R_{\theta JA}$	75	°C/W

Notes: 1. Non-repetitive current pulse, per Fig.3 and derated above  $T_A=25^\circ\text{C}$  per Fig.2.

2. Mounted on 8.0mm×8.0mm copper pads to each terminal.

3. 8.3ms single half sine-wave, or equivalent square wave, duty cycle=4 pulses per minutes maximum.

**Dimensions (SMC/DO-214AB)**

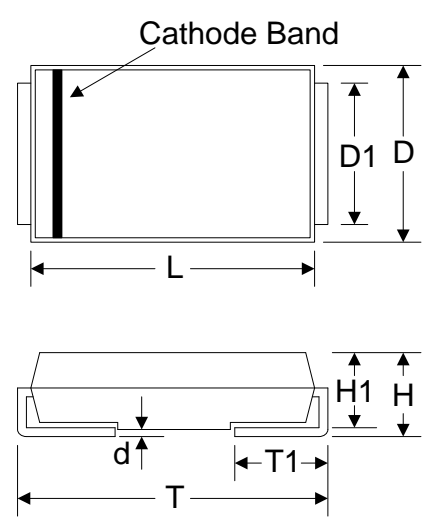
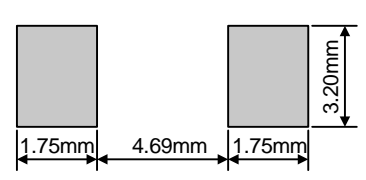
<p>Product:</p>  <p>Pad:</p> 	Symbol	Millimeters		Inches	
		Min.	Max.	Min.	Max.
	L	6.60	7.11	0.260	0.280
	D	5.59	6.22	0.220	0.245
	D1	2.90	3.20	0.114	0.126
	T	7.75	8.13	0.305	0.320
	T1	0.76	1.52	0.030	0.060
	d	-	0.203	-	0.008
	H	2.20	2.80	0.087	0.110
	H1	2.06	2.62	0.079	0.103

**Electrical Characteristics (T<sub>A</sub>=25°C)**

Part Number		Device Marking Code		Reverse Stand-Off Voltage	Breakdown Voltage @I <sub>T</sub>	Test Current	Maximum Clamping Voltage @I <sub>PP</sub>	Peak Pulse Current	Reverse Leakage @V <sub>RWM</sub>
Unidirectional	Bidirectional	UNI	BI	V <sub>RWM</sub> (V)	V <sub>BR</sub> (V)	I <sub>T</sub> (mA)	V <sub>C</sub> (V)	I <sub>PP</sub> (A)	I <sub>R</sub> (μA)
5.0SMDJ11A-AT	5.0SMDJ11CA-AT	5PEN	5BEN	11.0	12.20~13.50	10	18.2	275.00	800
5.0SMDJ12A-AT	5.0SMDJ12CA-AT	5PEP	5BEP	12.0	13.30~14.70	10	19.9	252.00	800
5.0SMDJ13A-AT	5.0SMDJ13CA-AT	5PEQ	5BEQ	13.0	14.40~15.90	10	21.5	233.00	500
5.0SMDJ14A-AT	5.0SMDJ14CA-AT	5PER	5BER	14.0	15.60~17.20	10	23.2	216.00	200
5.0SMDJ15A-AT	5.0SMDJ15CA-AT	5PES	5BES	15.0	16.70~18.50	1	24.4	205.00	100
5.0SMDJ16A-AT	5.0SMDJ16CA-AT	5PET	5BET	16.0	17.80~19.70	1	26.0	193.00	50
5.0SMDJ17A-AT	5.0SMDJ17CA-AT	5PEU	5BEU	17.0	18.90~20.90	1	27.6	181.00	20
5.0SMDJ18A-AT	5.0SMDJ18CA-AT	5PEV	5BEV	18.0	20.00~22.10	1	29.2	172.00	10
5.0SMDJ20A-AT	5.0SMDJ20CA-AT	5PEW	5BEW	20.0	22.20~24.50	1	32.4	155.00	5
5.0SMDJ22A-AT	5.0SMDJ22CA-AT	5PEX	5BEX	22.0	24.40~26.90	1	35.5	141.00	5
5.0SMDJ24A-AT	5.0SMDJ24CA-AT	5PEZ	5BEZ	24.0	26.70~29.50	1	38.9	129.00	2
5.0SMDJ26A-AT	5.0SMDJ26CA-AT	5PFE	5BFE	26.0	28.90~31.90	1	42.1	119.00	2

Part Number		Device Marking Code		Reverse Stand-Off Voltage	Breakdown Voltage @ $I_T$	Test Current	Maximum Clamping Voltage @ $I_{PP}$	Peak Pulse Current	Reverse Leakage @ $V_{RWM}$
Unidirectional	Bidirectional	UNI	BI	$V_{RWM}(V)$	$V_{BR}(V)$	$I_T(mA)$	$V_C(V)$	$I_{PP}(A)$	$I_R(\mu A)$
5.0SMDJ28A-AT	5.0SMDJ28CA-AT	5PFG	5BFG	28.0	31.10~34.40	1	45.4	110.00	2
5.0SMDJ30A-AT	5.0SMDJ30CA-AT	5PFK	5BFK	30.0	33.30~36.80	1	48.4	103.00	2
5.0SMDJ33A-AT	5.0SMDJ33CA-AT	5PFM	5BFM	33.0	36.70~40.60	1	53.3	93.90	2
5.0SMDJ36A-AT	5.0SMDJ36CA-AT	5PFP	5BFP	36.0	40.00~44.20	1	58.1	86.10	2
5.0SMDJ40A-AT	5.0SMDJ40CA-AT	5PFR	5BFR	40.0	44.40~49.10	1	64.5	77.60	2
5.0SMDJ43A-AT	5.0SMDJ43CA-AT	5PFT	5BFT	43.0	47.80~52.80	1	69.4	72.10	2
5.0SMDJ45A-AT	5.0SMDJ45CA-AT	5PFV	5BFV	45.0	50.00~55.30	1	72.7	68.80	2
5.0SMDJ48A-AT	5.0SMDJ48CA-AT	5PFX	5BFX	48.0	53.30~58.90	1	77.4	64.70	2
5.0SMDJ51A-AT	5.0SMDJ51CA-AT	5PFZ	5BFZ	51.0	56.70~62.70	1	82.4	60.70	2
5.0SMDJ54A-AT	5.0SMDJ54CA-AT	5PGE	5BGE	54.0	60.00~66.30	1	87.1	57.50	2
5.0SMDJ58A-AT	5.0SMDJ58CA-AT	5PGG	5BGG	58.0	64.40~71.20	1	93.6	53.50	2
5.0SMDJ60A-AT	5.0SMDJ60CA-AT	5PGK	5BGK	60.0	66.70~73.70	1	96.8	51.70	2
5.0SMDJ64A-AT	5.0SMDJ64CA-AT	5PGM	5BGM	64.0	71.10~78.60	1	103.0	48.60	2
5.0SMDJ70A-AT	5.0SMDJ70CA-AT	5PGP	5BGP	70.0	77.80~86.00	1	113.0	44.30	2
5.0SMDJ75A-AT	5.0SMDJ75CA-AT	5PGR	5BGR	75.0	83.30~92.10	1	121.0	41.40	2
5.0SMDJ78A-AT	5.0SMDJ78CA-AT	5PGT	5BGT	78.0	86.70~95.80	1	126.0	39.70	2
5.0SMDJ85A-AT	5.0SMDJ85CA-AT	5PGV	5BGV	85.0	94.40~104.00	1	137.0	36.50	2
5.0SMDJ90A-AT	5.0SMDJ90CA-AT	5PGX	5BGX	90.0	100.00~111.00	1	146.0	34.30	2
5.0SMDJ100A-AT	5.0SMDJ100CA-AT	5PGZ	5BGZ	100.0	111.00~123.00	1	162.0	30.90	2
5.0SMDJ110A-AT	5.0SMDJ110CA-AT	5PHE	5BHE	110.0	122.00~135.00	1	177.0	28.30	2
5.0SMDJ120A-AT	5.0SMDJ120CA-AT	5PHG	5BHG	120.0	133.00~147.00	1	193.0	26.00	2
5.0SMDJ130A-AT	5.0SMDJ130CA-AT	5PHK	5BHK	130.0	144.00~159.00	1	209.0	24.00	2
5.0SMDJ150A-AT	5.0SMDJ150CA-AT	5PHM	5BHM	150.0	167.00~185.00	1	243.0	20.60	2
5.0SMDJ160A-AT	5.0SMDJ160CA-AT	5PHP	5BHP	160.0	178.00~197.00	1	259.0	19.30	2
5.0SMDJ170A-AT	5.0SMDJ170CA-AT	5PHR	5BHR	170.0	189.00~209.00	1	275.0	18.20	2

**Ratings and Characteristic Curves ( $T_A=25^\circ\text{C}$  unless otherwise noted)**

**Figure 1. Peak Pulse Power Rating Curve**

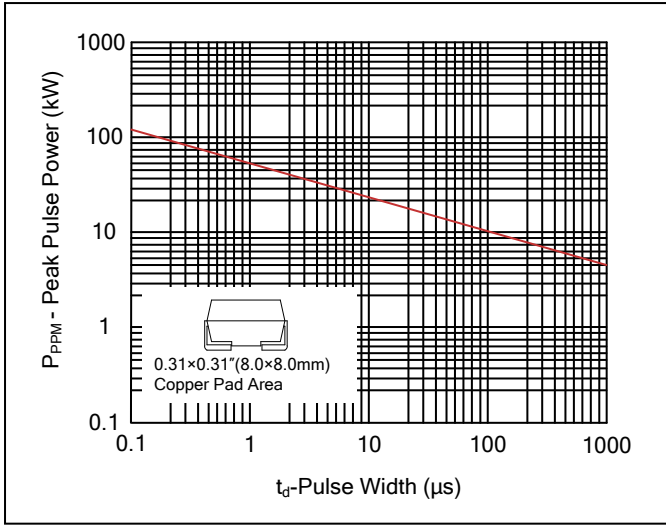

**Figure 2. Pulse Derating Curve**

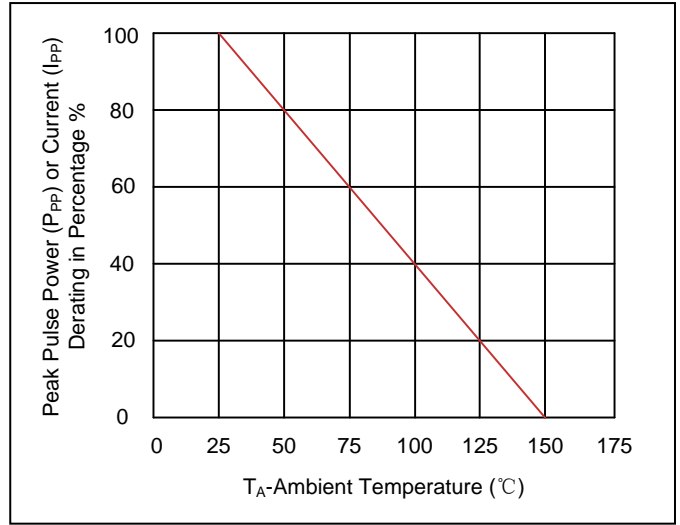

**Figure 3. Pulse Waveform**

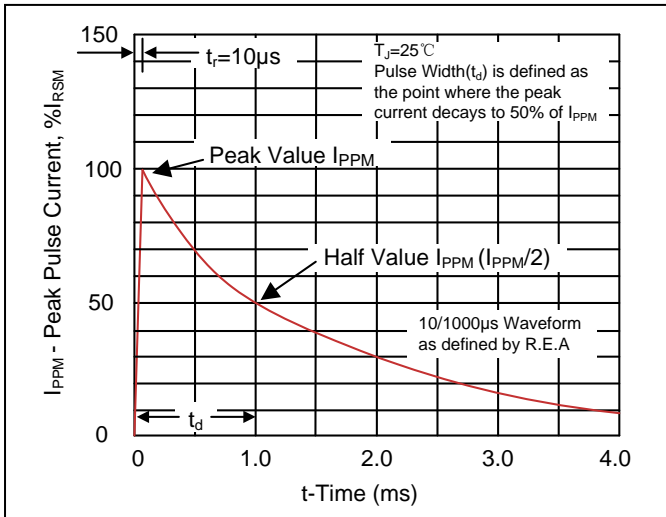

**Figure 4. Typical Junction Capacitance**

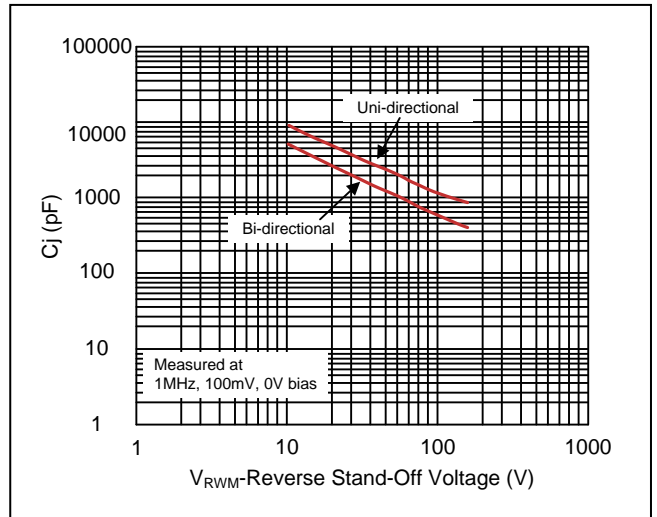

**Figure 5. Steady State Power Dissipation Derating Curve**

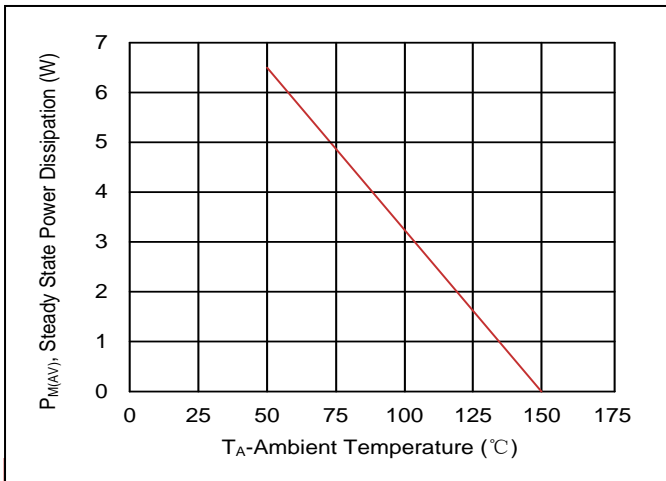

**Figure 6. Maximum Non-Repetitive Forward Surge Current Uni-Directional Only**

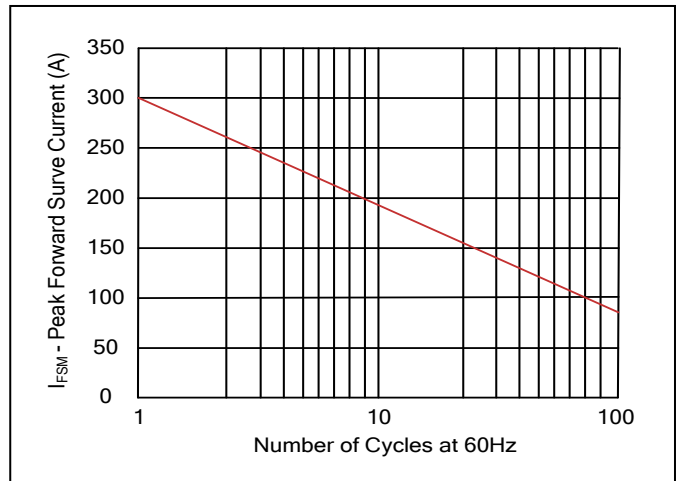

**Recommended Soldering Conditions**

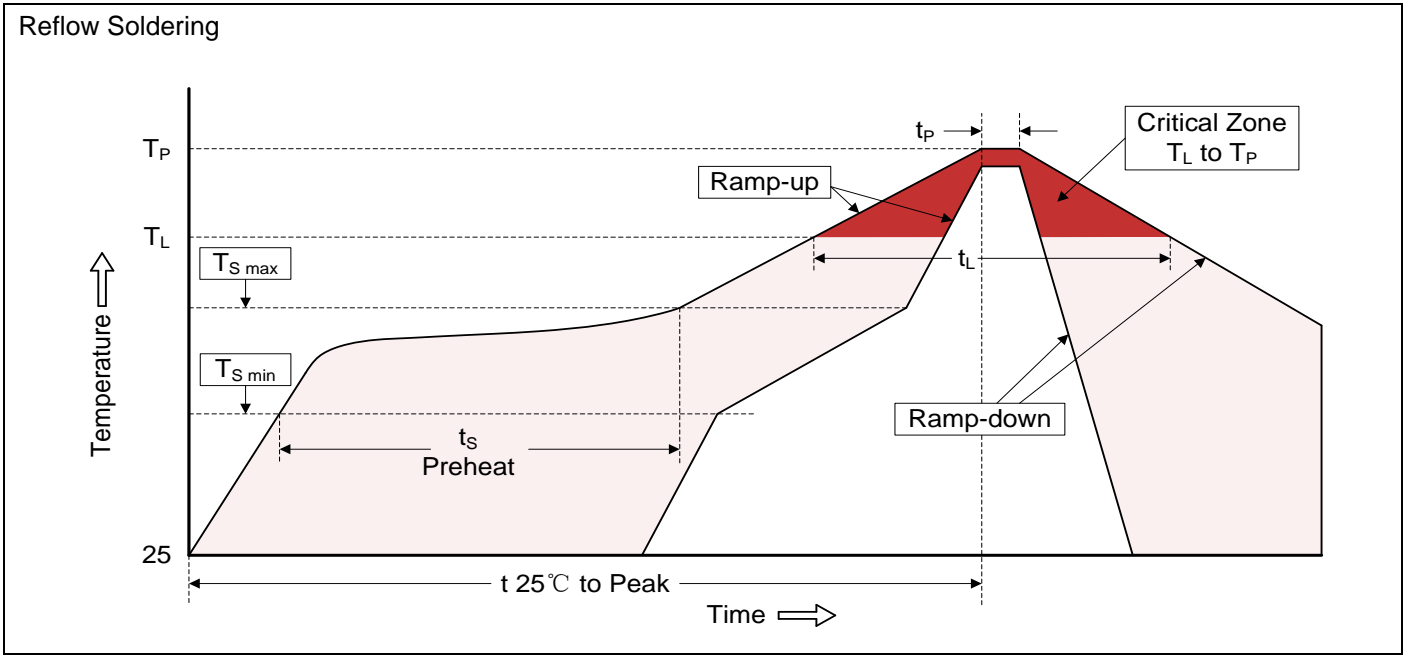

Recommended Conditions

Profile Feature	Pb-Free Assembly
Average ramp-up rate ( $T_L$ to $T_P$ )	3°C/second max.
Preheat -Temperature Min ( $T_{S\ min}$ ) -Temperature Max ( $T_{S\ max}$ ) -Time (min to max) ( $t_s$ )	150°C 200°C 60-180 seconds
$T_{S\ max}$ to $T_L$ -Ramp-up Rate	3°C/second max.
Time maintained above: -Temperature ( $T_L$ ) -Time ( $t_L$ )	217°C 60-150 seconds
Peak Temperature ( $T_P$ )	260°C
Time within 5°C of actual Peak Temperature ( $t_P$ )	20-40 seconds
Ramp-down Rate	6°C/second max.
Time 25°C to Peak Temperature	8 minutes max.

### Marking Code

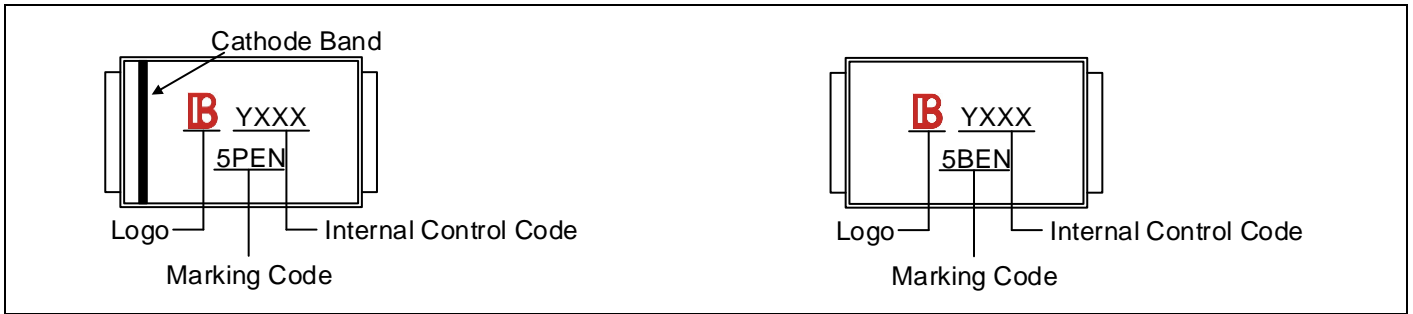

### Part Number Code

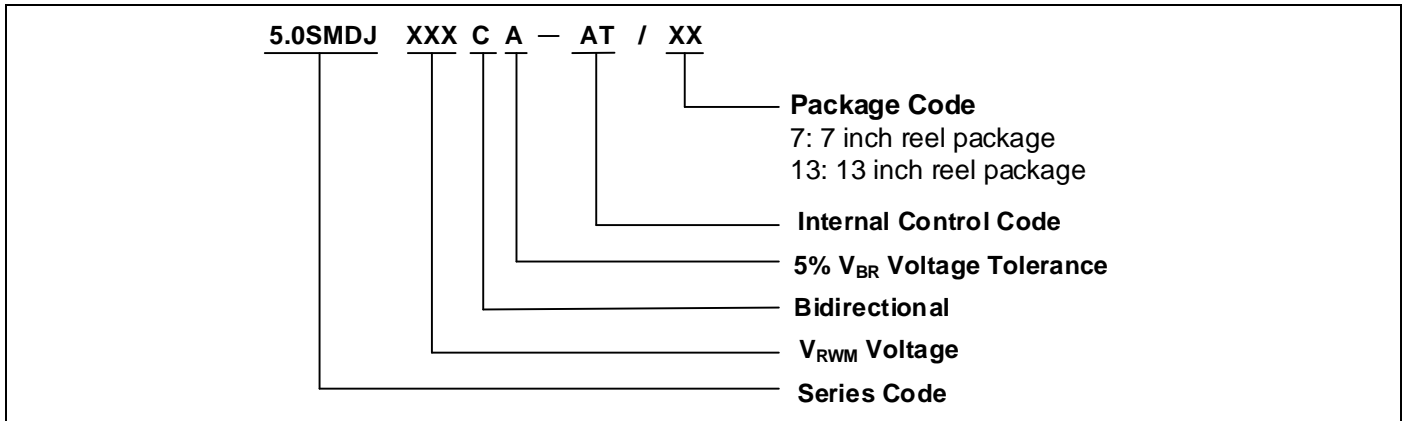

### Ordering Code for Different Package

7 inch reel package: Add suffix "/7" at the end of the part number, such as 5.0SMDJXXXCA-AT/7

13 inch reel package: Add suffix "/13" at the end of the part number, such as 5.0SMDJXXXCA-AT/13

**Packaging**

Tape	Symbol	Dimension (mm)
	W	16.00±0.20
	P0	4.00±0.10
	P1	8.00±0.10
	P2	2.00±0.10
	D0	Φ1.5±0.10
	D1	Φ1.5±0.10
	E	1.75±0.10
	F	7.50±0.10
	A0	6.27±0.10
	B0	8.30±0.10
	K0	3.15±0.15
	T	0.30±0.05
	D2	Φ178.0±2.0
	D3	Φ50.0Min.
D4	Φ13.0±0.5	
W1	20.0±2.0	
Quantity: 500PCS		
	D5	Φ330.0±2.0
	D6	Φ13.5±0.5
	H	2.5±1.0
	W2	20.0±2.0
	Quantity: 3000PCS	