

MARK	PLACES	ZONE	ECN	DATE

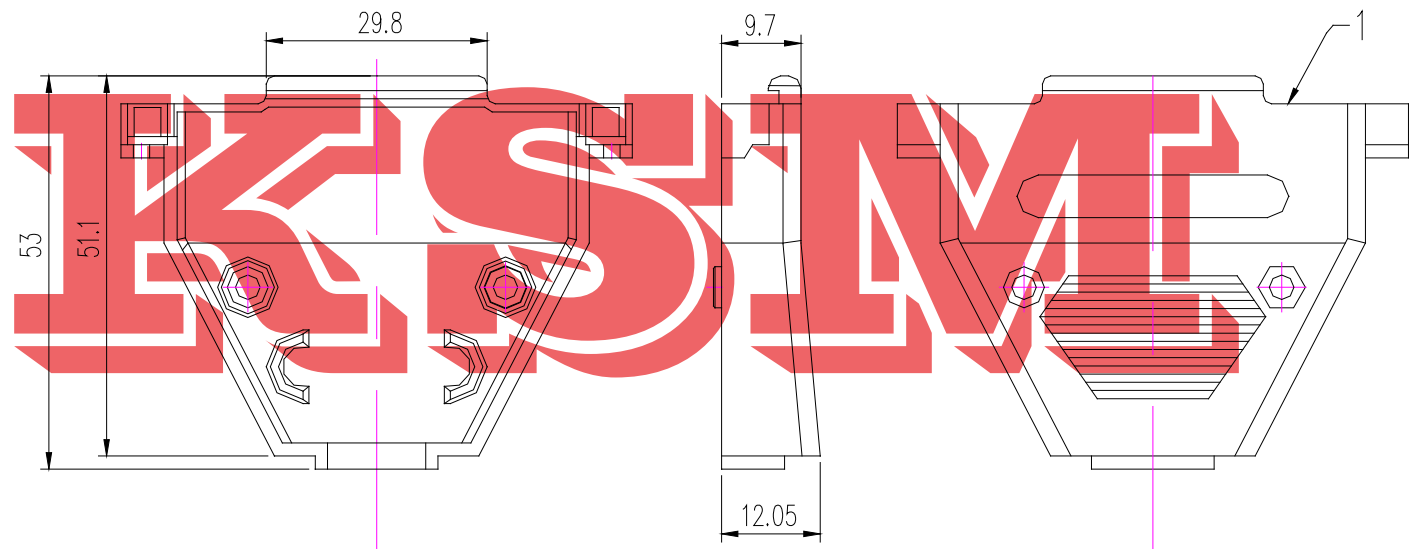

BOM LIST			
ITEM	PART NAME	Q'ty	NOTES
1	PLASTIC HOOD	2	ABS
2	2.1 LONG BOLT	2	#4-40
	2.2 SHORT BOLT	2	#4-40
3	NUT	2	M3
4	LONG SCREW	2	M3
5	SMALL WASHER	2	
6	SHORT SCREW	2	M3
7	7.1 METAL WASHER	2	M3
	7.2 PLASTIC-1 WASHER	2	ABS
	7.3 PLASTIC-2 WASHER	2	ABS

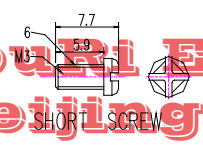
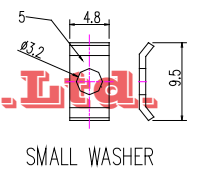
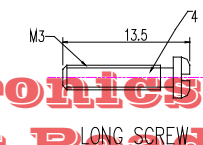
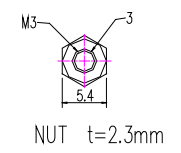
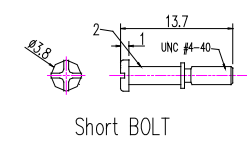
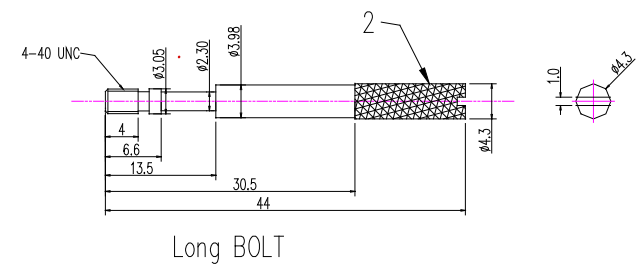
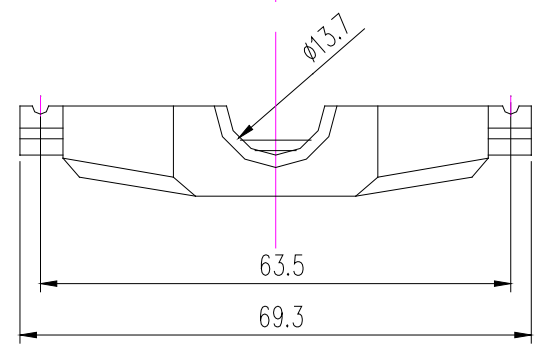

Shanghai ZhouRi Electronics CO., Ltd.

Add: No. 668 Beijing East Road

Tel: 86-21-51571121 53085565

Fax: 86-21-51571120

Http: www.ksmchina.com

E-mail: zhouri11@163.com

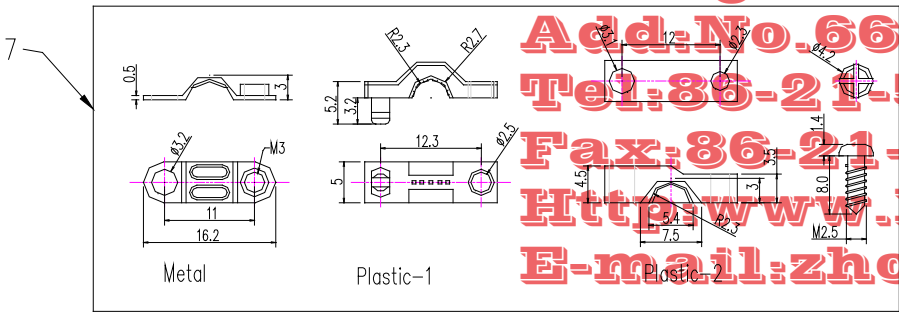

DIMENSION	TOLERANCE	
	DECIMAL	ANGLE
X.X	+0.2	+0.5°
X.XX	+0.1	±0°
X.XXX	+0.05	

UNLESS OTHERWISE SPECIFIED		37 D-SUB	
DESIGNED	Item NO.	MODEL NO.	DB Hood
CHECKED	REV.	DWG. NO.	ZR-Hood-004
APPROVED	SCALE	THE THIRD ANGLE PROJECTION	

上海洲日电子有限公司			
Shanghai ZhouRi Electronics CO.,LTD.			
MATERIAL		FINISH	
COLOR		QUANTITY	
UNIT	mm	SIZE	A4
SHEET	OF	PAGES	