

Features

- $V_{DS} = 60V, I_D = 3.5A$
 $R_{DS(ON)} < 100m\Omega @ V_{GS} = 10V$
 $R_{DS(ON)} < 120m\Omega @ V_{GS} = 4.5V$
- High Power and current handling capability
- Lead free product is acquired
- Surface mount package

Application

- Load/Power Switching
- Interfacing Switching
- Battery Management for Ultra Small Portable Electronics
- Logic Level Shift

Package and Pin Configuration

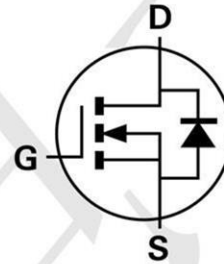
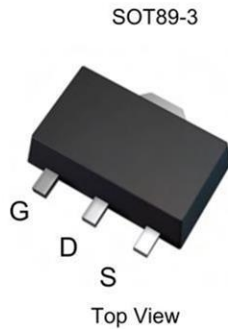

Marking:  603N

Absolute Maximum Ratings ($T_A = 25^\circ C$ unless otherwise noted)

Parameter	Symbol	Limit	Unit
Drain-Source Voltage	V_{DS}	60	V
Gate-Source Voltage	V_{GS}	± 20	V
Drain Current-Continuous	I_D	3.5	A
Drain Current-Pulsed ^(Note 1)	I_{DM}	10	A
Maximum Power Dissipation	P_D	1.7	W
Operating Junction and Storage Temperature Range	T_J, T_{STG}	-55 To 150	$^\circ C$

Thermal Characteristic

Thermal Resistance, Junction-to-Ambient ^(Note 2)	$R_{\theta JA}$	73.5	$^\circ C/W$
---	-----------------	------	--------------

Electrical Characteristics ($T_A=25^\circ\text{C}$ unless otherwise noted)

Parameter	Symbol	Condition	Min	Typ	Max	Unit
Off Characteristics						
Drain-Source Breakdown Voltage	BV_{DSS}	$V_{GS}=0V, I_D=250\mu A$	60	-		V
Zero Gate Voltage Drain Current	I_{DSS}	$V_{DS}=60V, V_{GS}=0V$	-	-	1	μA
Parameter						
Gate-Body Leakage Current	I_{GSS}	$V_{GS}=\pm 20V, V_{DS}=0V$	-	-	± 100	nA
On Characteristics (Note 3)						
Gate Threshold Voltage	$V_{GS(th)}$	$V_{DS}=V_{GS}, I_D=250\mu A$	1		2.3	V
Drain-Source On-State Resistance	$R_{DS(on)}$	$V_{GS}=10V, I_D=3A$	-	62		m Ω
		$V_{GS}=4.5V, I_D=3A$	-	-	120	m Ω
Forward Transconductance	g_{FS}	$V_{DS}=15V, I_D=2A$	2	-	-	S
Dynamic Characteristics (Note 4)						
Input Capacitance	C_{iss}	$V_{DS}=30V, V_{GS}=0V,$ $F=1.0MHz$	-	247	-	PF
Output Capacitance	C_{oss}		-	34	-	PF
Reverse Transfer Capacitance	C_{rss}		-	19.5	-	PF
Switching Characteristics (Note 4)						
Turn-on Delay Time	$t_{d(on)}$	$V_{DD}=30V, I_D=1.5A$ $V_{GS}=10V, R_{GEN}=1\Omega$	-	6	-	nS
Turn-on Rise Time	t_r		-	15	-	nS
Turn-Off Delay Time	$t_{d(off)}$		-	15	-	nS
Turn-Off Fall Time	t_f		-	10	-	nS
Total Gate Charge	Q_g	$V_{DS}=30V, I_D=3A,$ $V_{GS}=4.5V$	-	6	-	nC
Gate-Source Charge	Q_{gs}		-	1	-	nC
Gate-Drain Charge	Q_{gd}		-	1.3	-	nC
Drain-Source Diode Characteristics						
Diode Forward Voltage (Note 3)	V_{SD}	$V_{GS}=0V, I_S=3A$	-	-	1.2	V
Diode Forward Current (Note 2)	I_S		-	-	3	A

Typical Characteristics

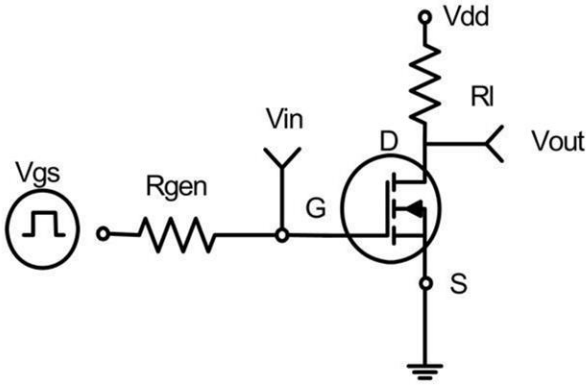

Figure 1 Switching Test Circuit

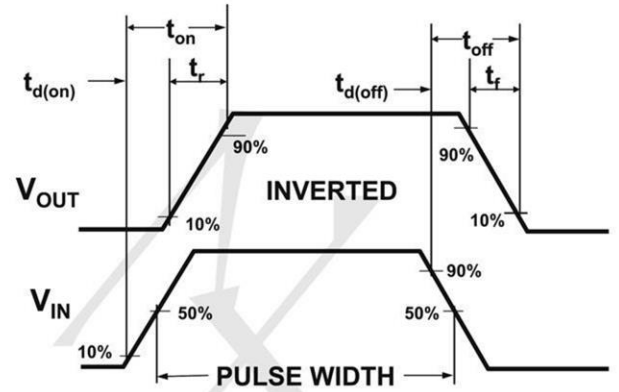

Figure 2 Switching Waveforms

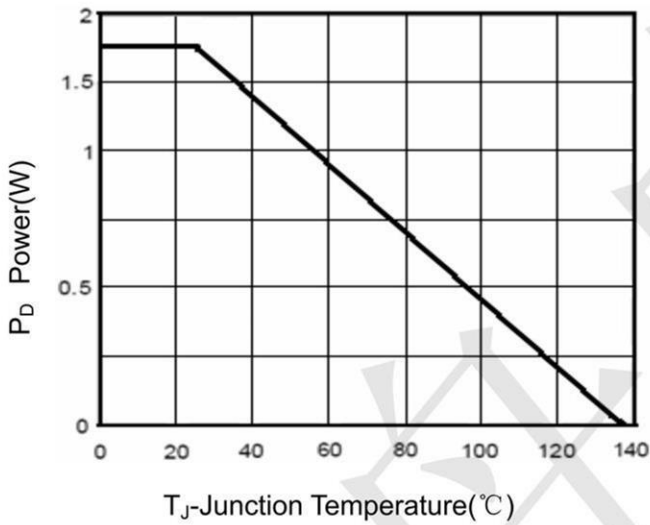

Figure 3 Power Dissipation

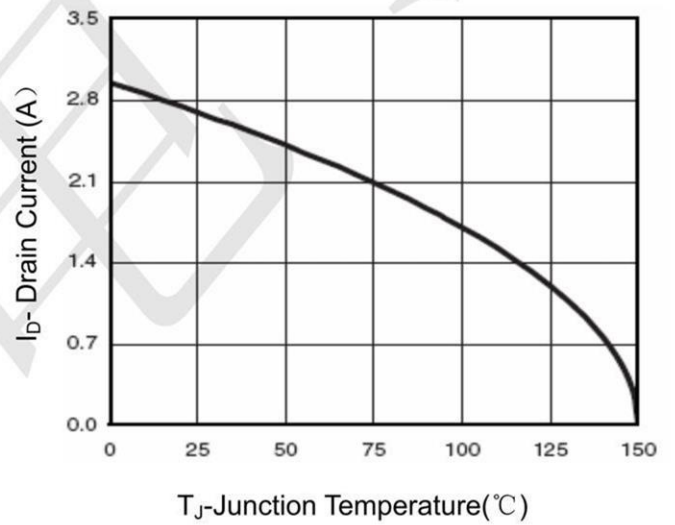

Figure 4 Drain Current

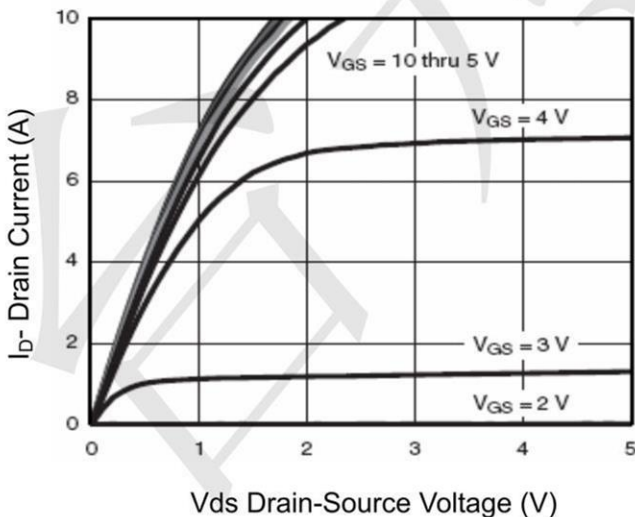

Figure 5 Output Characteristics

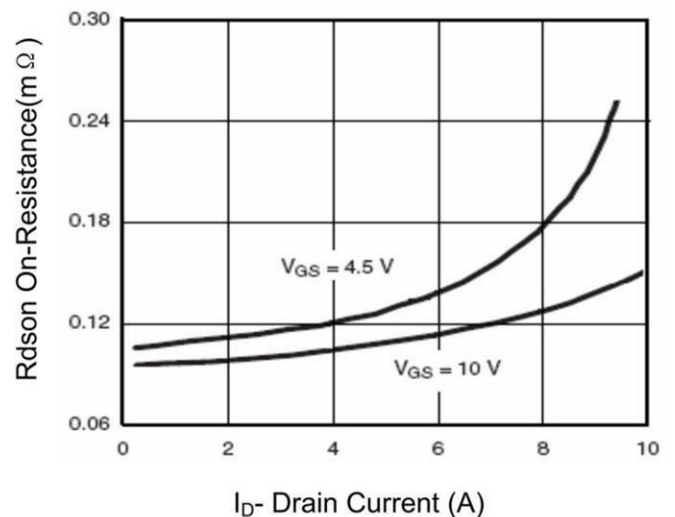
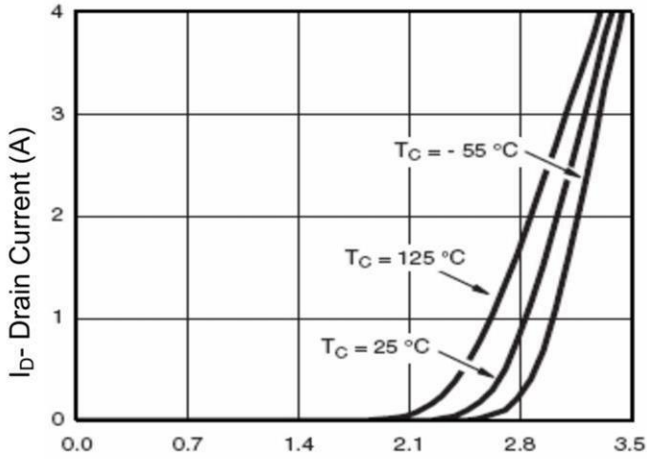
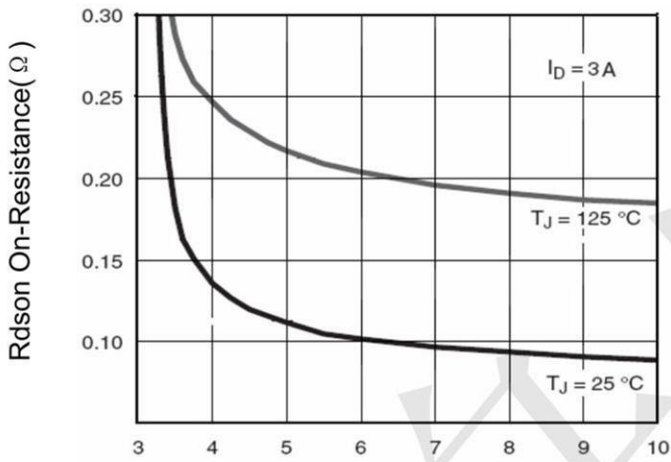

Figure 6 Drain-Source On-Resistance



Vgs Gate-Source Voltage (V)
Figure 7 Transfer Characteristics



Vgs Gate-Source Voltage (V)
Figure 9 Rdson vs Vgs

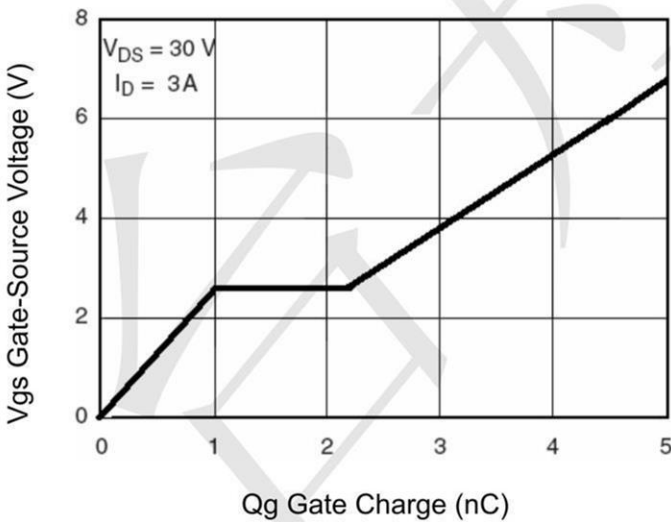

Qg Gate Charge (nC)
Figure 11 Gate Charge

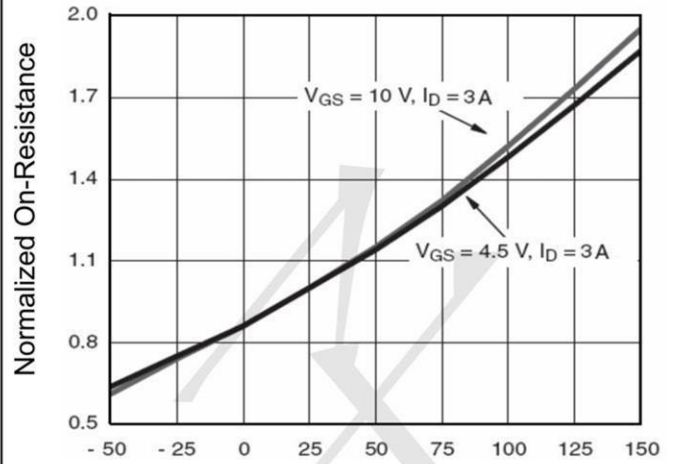

T_J -Junction Temperature($^\circ\text{C}$)
Figure 8 Drain-Source On-Resistance

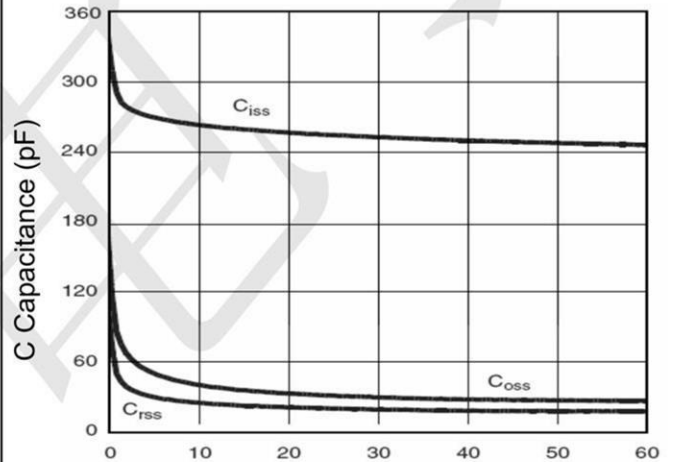

Vds Drain-Source Voltage (V)
Figure 10 Capacitance vs Vds

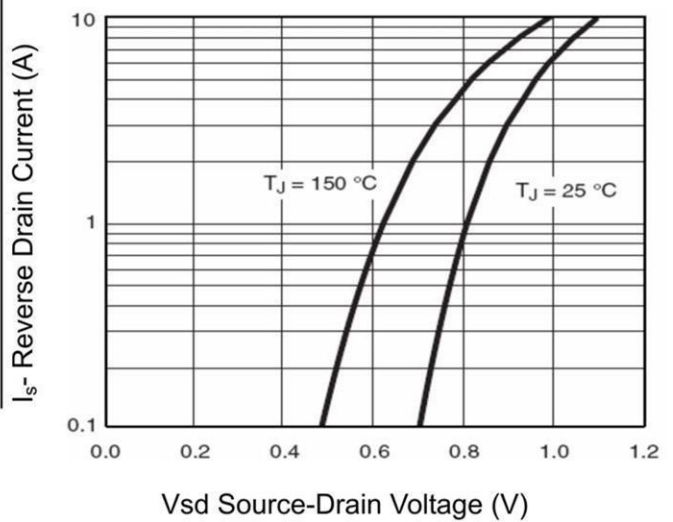

Vsd Source-Drain Voltage (V)
Figure 12 Source- Drain Diode Forward

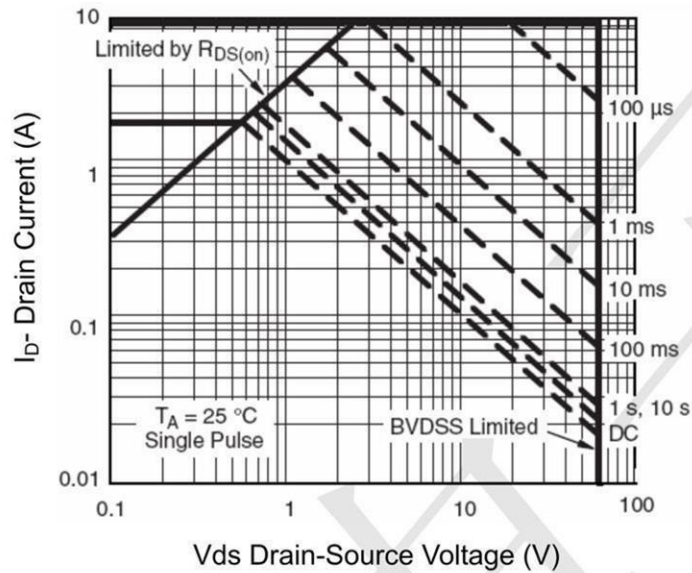

Figure 13 Safe Operation Area

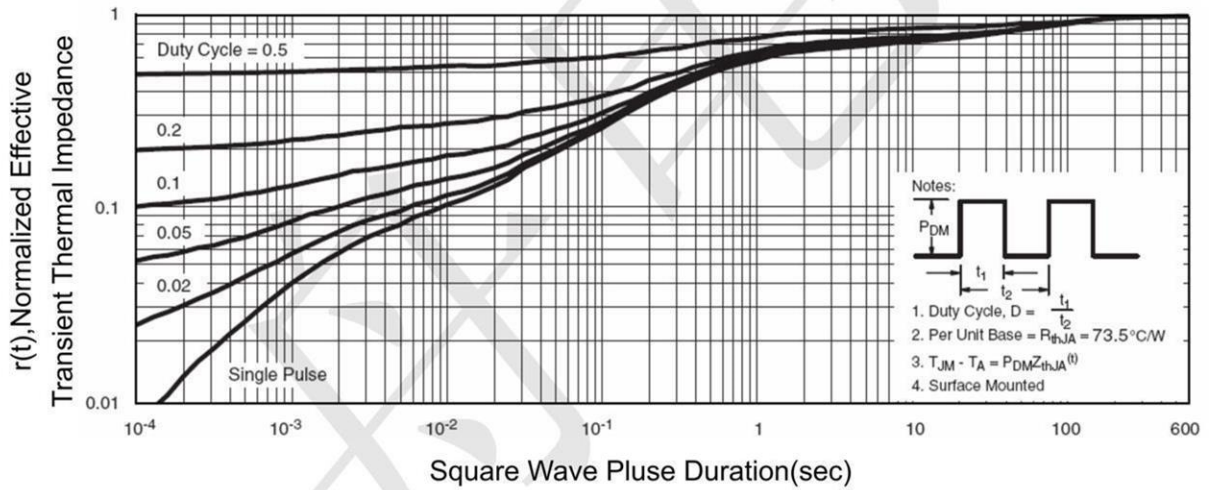
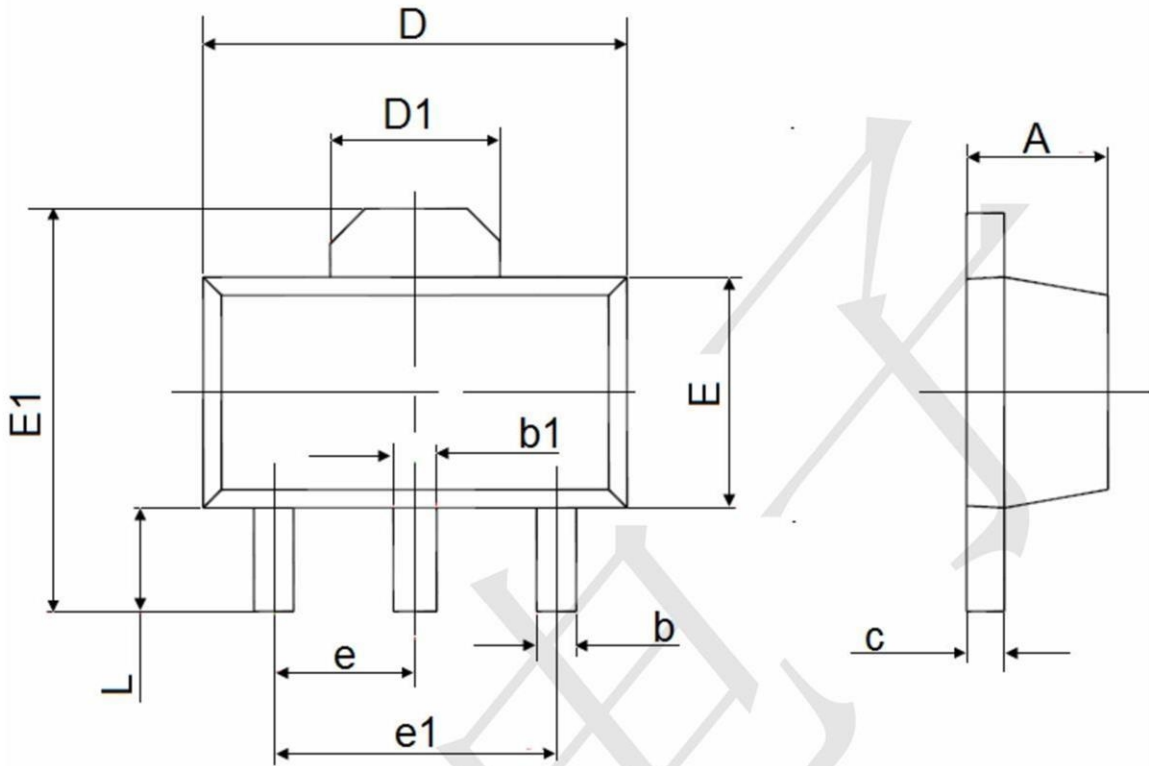

Figure 14 Normalized Maximum Transient Thermal Impedance

SOT-89-3L Package Information



Symbol	Dimensions In Millimeters		Dimensions In Inches	
	Min	Max	Min	Max
A	1.400	1.600	0.055	0.063
b	0.320	0.520	0.013	0.020
b1	0.400	0.580	0.016	0.023
c	0.350	0.440	0.014	0.017
D	4.400	4.600	0.173	0.181
D1	1.550 REF.		0.061 REF.	
E	2.300	2.600	0.091	0.102
E1	3.940	4.250	0.155	0.167
e	1.500 TYP.		0.060 TYP.	
e1	3.000 TYP.		0.118 TYP.	
L	0.900	1.200	0.035	0.047