

### GENERAL DESCRIPTION

The SGM2061 is a low noise, high PSRR and low dropout voltage linear regulator. It is capable of supplying 450mA output current with typical dropout voltage of only 70mV. The operating input voltage range is from 1.9V to 5.5V. The fixed output voltages are 1.8V, 2.5V, 2.8V, 3.0V, 3.3V and 5.0V.

Other features include logic-controlled shutdown mode, short-circuit current limit and thermal shutdown protection. The SGM2061 has automatic discharge function to quickly discharge  $V_{OUT}$  in the disabled status.

The SGM2061 is suitable for applications which need low noise and fast transient response power supply, such as power supply of camera module in smart phone, etc.

The SGM2061 is available in an ultra-thin Green WLCSP-0.64×0.64-4B-A package. It operates over an operating temperature range of -40°C to +125°C.

### FEATURES

- **Operating Input Voltage Range: 1.9V to 5.5V**
- **Fixed Outputs of 1.8V, 2.5V, 2.8V, 3.0V, 3.3V, 5.0V**
- **Ultra-Low Quiescent Current: 15µA (TYP)**
- **Low Dropout Voltage:**  
70mV (TYP) at 450mA,  $V_{OUT} = 2.8V$
- **Ultra-Low Noise: 10µV<sub>RMS</sub> (TYP)**
- **High PSRR: 92dB (TYP) at 1kHz**
- **Standby Current: 0.03µA (TYP)**
- **Current Limiting and Thermal Protection**
- **Excellent Load and Line Transient Responses**
- **With Output Automatic Discharge**
- **Stable with Small Case Size Ceramic Capacitors**
- **-40°C to +125°C Operating Temperature Range**
- **Available in an Ultra-Thin Green  
WLCSP-0.64×0.64-4B-A Package**

### APPLICATIONS

- Portable Electronic Devices
- Smoke Detectors
- IP Cameras
- Wireless LAN Devices
- Battery-Powered Equipment
- Smartphones and Tablets
- Digital Cameras and Audio Devices

### TYPICAL APPLICATION

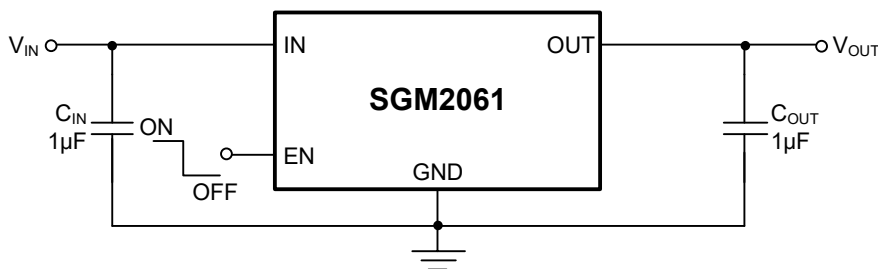

Figure 1. Typical Application Circuit

## PACKAGE/ORDERING INFORMATION

| MODEL       | PACKAGE DESCRIPTION  | SPECIFIED TEMPERATURE RANGE | ORDERING NUMBER  | PACKAGE MARKING | PACKING OPTION      |
|-------------|----------------------|-----------------------------|------------------|-----------------|---------------------|
| SGM2061-1.8 | WLCSP-0.64×0.64-4B-A | -40°C to +125°C             | SGM2061-1.8XG/TR | QF              | Tape and Reel, 5000 |
| SGM2061-2.5 | WLCSP-0.64×0.64-4B-A | -40°C to +125°C             | SGM2061-2.5XG/TR | R0              | Tape and Reel, 5000 |
| SGM2061-2.8 | WLCSP-0.64×0.64-4B-A | -40°C to +125°C             | SGM2061-2.8XG/TR | R1              | Tape and Reel, 5000 |
| SGM2061-3.0 | WLCSP-0.64×0.64-4B-A | -40°C to +125°C             | SGM2061-3.0XG/TR | R2              | Tape and Reel, 5000 |
| SGM2061-3.3 | WLCSP-0.64×0.64-4B-A | -40°C to +125°C             | SGM2061-3.3XG/TR | R3              | Tape and Reel, 5000 |
| SGM2061-5.0 | WLCSP-0.64×0.64-4B-A | -40°C to +125°C             | SGM2061-5.0XG/TR | R4              | Tape and Reel, 5000 |

## MARKING INFORMATION

YY

Serial Number

Green (RoHS & HSF): SG Micro Corp defines "Green" to mean Pb-Free (RoHS compatible) and free of halogen substances. If you have additional comments or questions, please contact your SGMICRO representative directly.

## ABSOLUTE MAXIMUM RATINGS

|   |                              |
|---|------------------------------|
| IN to GND .....                           | -0.3V to 6V                  |
| OUT to GND .....                          | -0.3V to ( $V_{IN} + 0.3V$ ) |
| EN to GND.....                            | -0.3V to 6V                  |
| Package Thermal Resistance                |                              |
| WLCSP-0.64×0.64-4B-A, $\theta_{JA}$ ..... | 285°C/W                      |
| WLCSP-0.64×0.64-4B-A, $\theta_{JB}$ ..... | 50°C/W                       |
| WLCSP-0.64×0.64-4B-A, $\theta_{JC}$ ..... | 116°C/W                      |
| Junction Temperature.....                 | +150°C                       |
| Storage Temperature Range .....           | -65°C to +150°C              |
| Lead Temperature (Soldering, 10s) .....   | +260°C                       |
| ESD Susceptibility                        |                              |
| HBM.....                                  | 8000V                        |
| CDM .....                                 | 1000V                        |

## RECOMMENDED OPERATING CONDITIONS

|   |                           |
|---|---------------------------|
| Input Voltage Range .....                     | 1.9V to 5.5V              |
| Enable Input Voltage Range .....              | 0V to 5.5V                |
| Input Effective Capacitance, $C_{IN}$ .....   | 0.1 $\mu$ F (MIN)         |
| Output Effective Capacitance, $C_{OUT}$ ..... | 0.5 $\mu$ F to 10 $\mu$ F |
| Operating Junction Temperature Range.....     | -40°C to +125°C           |

## OVERSTRESS CAUTION

Stresses beyond those listed in Absolute Maximum Ratings may cause permanent damage to the device. Exposure to absolute maximum rating conditions for extended periods may affect reliability. Functional operation of the device at any conditions beyond those indicated in the Recommended Operating Conditions section is not implied.

## ESD SENSITIVITY CAUTION

This integrated circuit can be damaged if ESD protections are not considered carefully. SGMICRO recommends that all integrated circuits be handled with appropriate precautions. Failure to observe proper handling and installation procedures can cause damage. ESD damage can range from subtle performance degradation to complete device failure. Precision integrated circuits may be more susceptible to damage because even small parametric changes could cause the device not to meet the published specifications.

## DISCLAIMER

SG Micro Corp reserves the right to make any change in circuit design, or specifications without prior notice.

## PIN CONFIGURATION

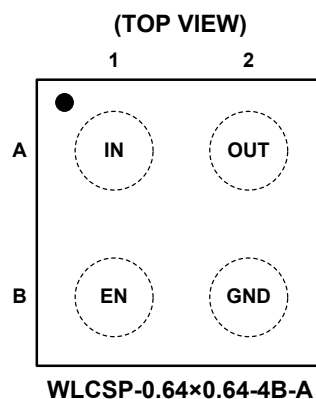

## PIN DESCRIPTION

| PIN | NAME | FUNCTION   |
|-----|------|--|
| A1  | IN   | Input Voltage Supply Pin. It is recommended to use a 1 $\mu$ F or larger ceramic capacitor from IN pin to ground. This ceramic capacitor should be placed as close as possible to IN pin.  |
| A2  | OUT  | Regulated Output Pin. It is recommended to use a ceramic capacitor with effective capacitance in the range of 0.5 $\mu$ F to 10 $\mu$ F to get good power supply decoupling. This ceramic capacitor should be placed as close as possible to OUT pin.  |
| B1  | EN   | Enable Pin. Drive EN high to turn on the regulator. Drive EN low to turn off the regulator. The EN pin has an internal 0.03 $\mu$ A pull-down current source which ensures that the device is turned off when the EN pin is floated. This pin must be connected to IN pin if enable functionality is not used. |
| B2  | GND  | Ground.  |

## ELECTRICAL CHARACTERISTICS

( $V_{IN} = V_{OUT(NOM)} + 1V$ ,  $V_{EN} = V_{IN}$ ,  $I_{OUT} = 1mA$ ,  $C_{IN} = C_{OUT} = 1\mu F$ ,  $T_J = -40^{\circ}C$  to  $+125^{\circ}C$ , typical values are at  $T_J = +25^{\circ}C$ , unless otherwise noted.)

| PARAMETER                      | SYMBOL                   | CONDITIONS   | MIN                                     | TYP   | MAX | UNITS         |
|--------------------------------|--------------------------|--|---|-------|-----|---------------|
| Operating Input Voltage        | $V_{IN}$                 |  | 1.9                                     |       | 5.5 | V             |
| Output Voltage Accuracy        | $V_{OUT}$                | $V_{IN} = (V_{OUT(NOM)} + 1V)$ to 5.5V, $I_{OUT} = 1mA$ , $T_J = +25^{\circ}C$ | -1                                      |       | 1   | %             |
|                                |                          | $V_{IN} = (V_{OUT(NOM)} + 1V)$ to 5.5V, $I_{OUT} = 1mA$ to 450mA               | -2.5                                    |       | 2.5 |               |
| Line Regulation                | $\Delta V_{LNR}$         | $V_{IN} = (V_{OUT(NOM)} + 1V)$ to 5.5V   |   | 0.05  | 2   | mV            |
| Load Regulation                | $\Delta V_{LDR}/V_{OUT}$ | $I_{OUT} = 1mA$ to 450mA   |   | 0.4   | 5   | mV/V          |
| Dropout Voltage <sup>(1)</sup> | $V_{DROP}$               | $I_{OUT} = 450mA$ , $V_{OUT(NOM)} = 2.8V$                                      |   | 70    | 130 | mV            |
| Output Current Limit           | $I_{LIMIT}$              | $V_{OUT} = 90\% \times V_{OUT(NOM)}$   | $T_J = -20^{\circ}C$ to $+125^{\circ}C$ | 450   | 900 | mA            |
|                                |                          |  | $T_J = -40^{\circ}C$ to $+125^{\circ}C$ | 400   | 900 |               |
| Short-Circuit Current          | $I_{SHORT}$              | $V_{OUT} = 0V$   |   | 500   |     | mA            |
| Quiescent Current              | $I_Q$                    | $I_{OUT} = 0mA$  |   | 15    | 40  | $\mu A$       |
| Shutdown Current               | $I_{SHDN}$               | $V_{EN} = 0V$ , $V_{IN} = 5.5V$  |   | 0.03  | 2   | $\mu A$       |
| EN Pin Threshold Voltage       | $V_{IH}$                 | $V_{IN} = 1.9V$ to 5.5V  | 1                                       |       |     | V             |
|                                | $V_{IL}$                 | $V_{IN} = 1.9V$ to 5.5V  |   |       | 0.6 |               |
| EN Pull-Down Current           | $I_{EN}$                 | $V_{EN} = 0V$ , $V_{IN} = 5.5V$  |   | 0.001 | 1   | $\mu A$       |
|                                |                          | $V_{EN} = 5.5V$ , $V_{IN} = 5.5V$  |   | 0.2   | 1   |               |
| Turn-On Time                   | $t_{ON}$                 | From assertion of $V_{EN}$ to $V_{OUT} = 90\% \times V_{OUT(NOM)}$             |   | 100   | 240 | $\mu s$       |
| Power Supply Rejection Ratio   | PSRR                     | $I_{OUT} = 20mA$ , $V_{IN} = V_{OUT(NOM)} + 1V$                                | $f = 100Hz$                             |       | 90  | dB            |
|                                |                          |  | $f = 1kHz$                              |       | 92  |               |
|                                |                          |  | $f = 10kHz$                             |       | 80  |               |
|                                |                          |  | $f = 100kHz$                            |       | 55  |               |
| Output Voltage Noise           | $e_n$                    | $f = 10Hz$ to 100kHz   | $I_{OUT} = 1mA$                         |       | 10  | $\mu V_{RMS}$ |
|                                |                          |  | $I_{OUT} = 250mA$                       |       | 9   |               |
| Output Discharge Resistance    | $R_{DIS}$                | $V_{EN} = 0V$ , $V_{OUT} = 0.2V$ , $V_{IN} = 3.3V$                             |   | 270   |     | $\Omega$      |
| Thermal Shutdown Temperature   | $T_{SHDN}$               |  |   | 160   |     | $^{\circ}C$   |
| Thermal Shutdown Hysteresis    | $\Delta T_{SHDN}$        |  |   | 20    |     | $^{\circ}C$   |

## NOTE:

1. The dropout voltage is defined as the difference between  $V_{IN}$  and  $V_{OUT}$  when  $V_{OUT}$  falls to  $(V_{OUT(NOM)} - 50mV)$ .

TYPICAL PERFORMANCE CHARACTERISTICS

$T_J = +25^\circ\text{C}$ ,  $V_{IN} = V_{OUT(NOM)} + 1\text{V}$ ,  $V_{EN} = V_{IN}$ ,  $C_{IN} = C_{OUT} = 1\mu\text{F}$ , unless otherwise noted.

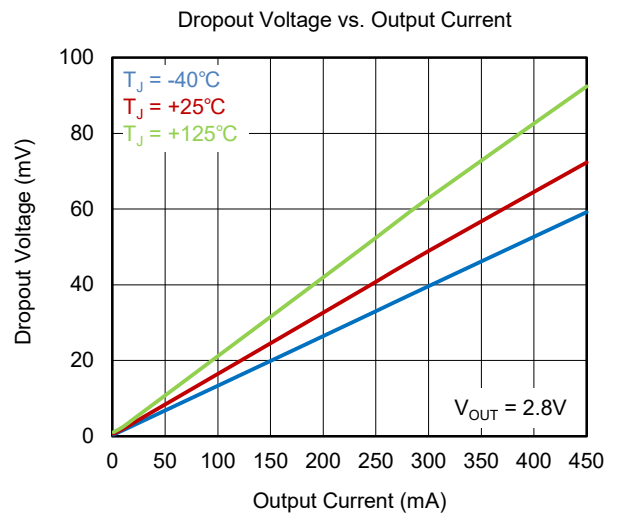
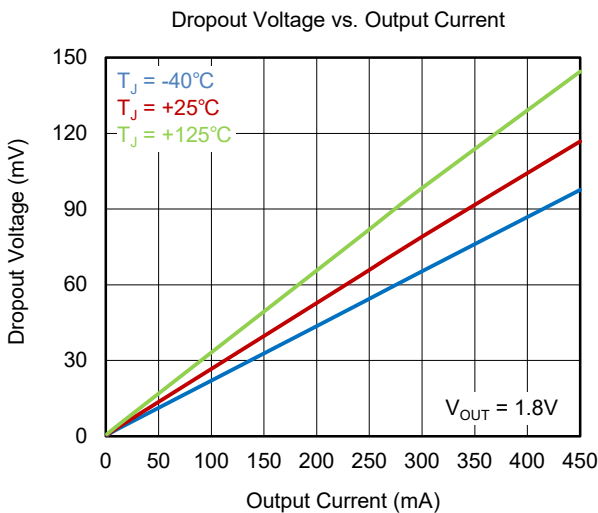
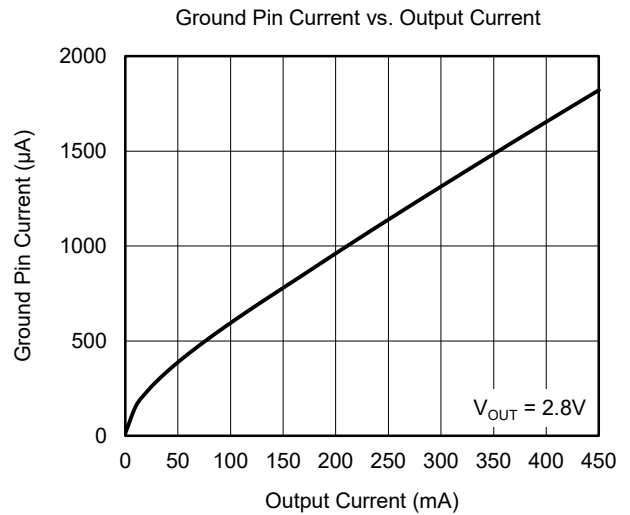
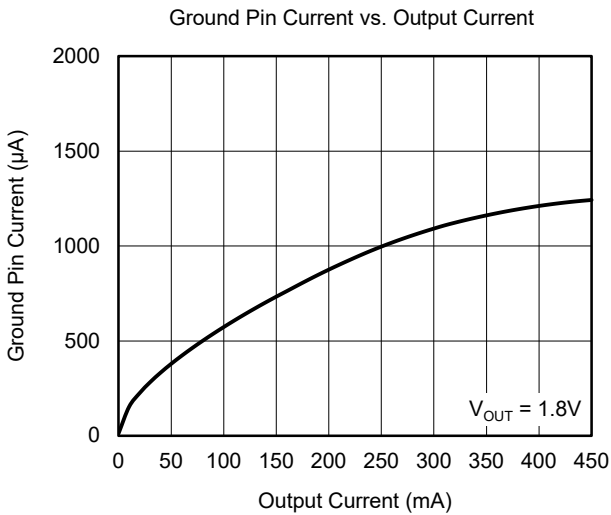
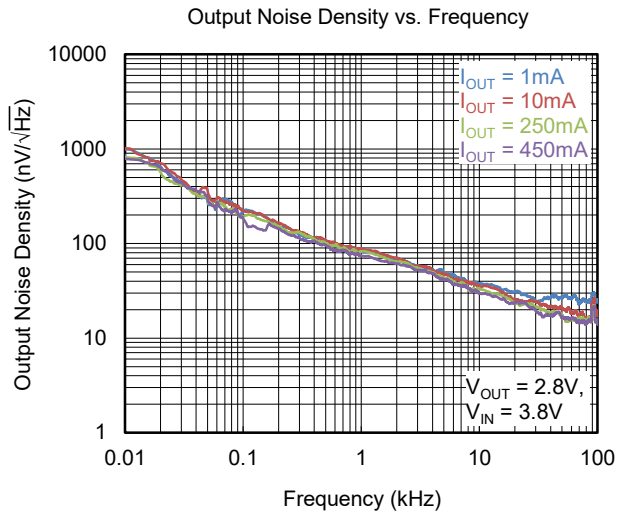
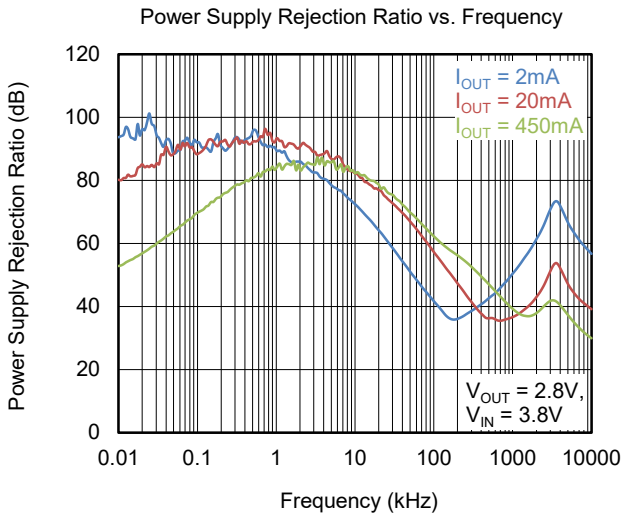

**TYPICAL PERFORMANCE CHARACTERISTICS (continued)**

$T_J = +25^\circ\text{C}$ ,  $V_{IN} = V_{OUT(NOM)} + 1\text{V}$ ,  $V_{EN} = V_{IN}$ ,  $C_{IN} = C_{OUT} = 1\mu\text{F}$ , unless otherwise noted.

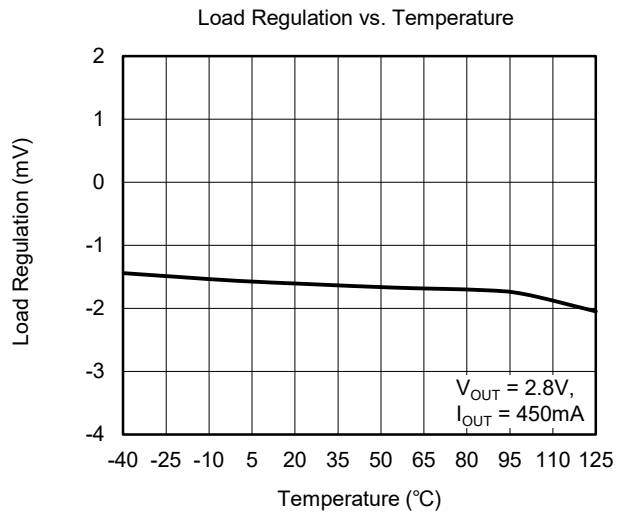
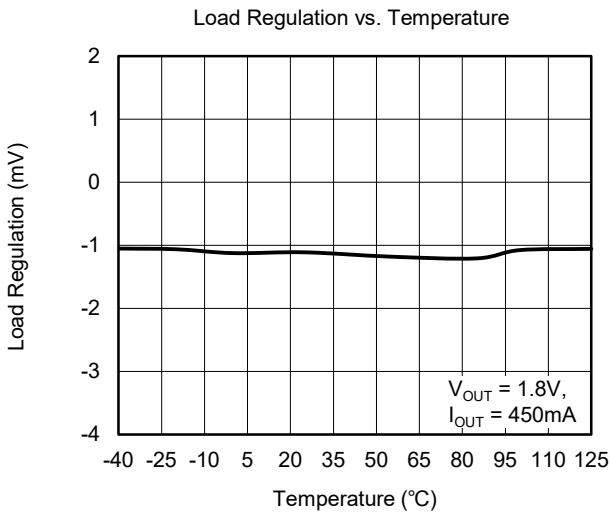
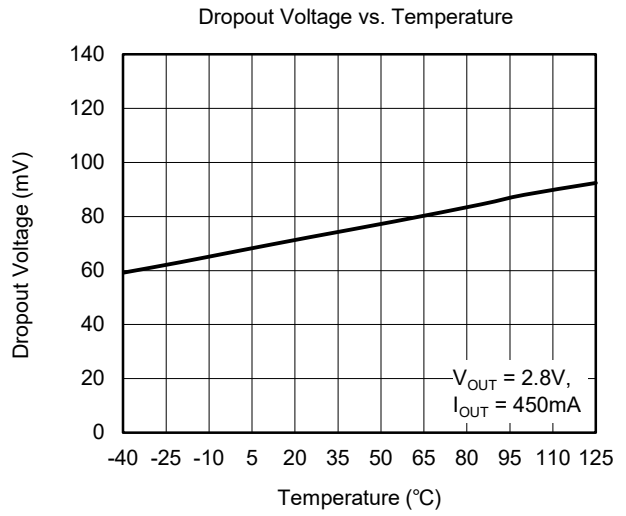
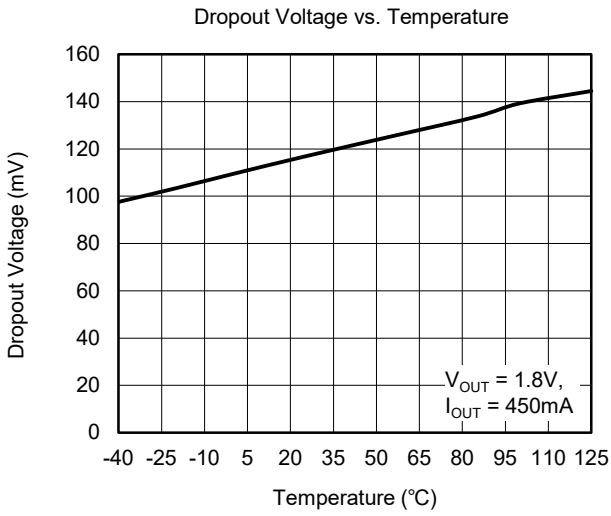

TYPICAL PERFORMANCE CHARACTERISTICS (continued)

$T_J = +25^\circ\text{C}$ ,  $V_{IN} = V_{OUT(NOM)} + 1\text{V}$ ,  $V_{EN} = V_{IN}$ ,  $C_{IN} = C_{OUT} = 1\mu\text{F}$ , unless otherwise noted.

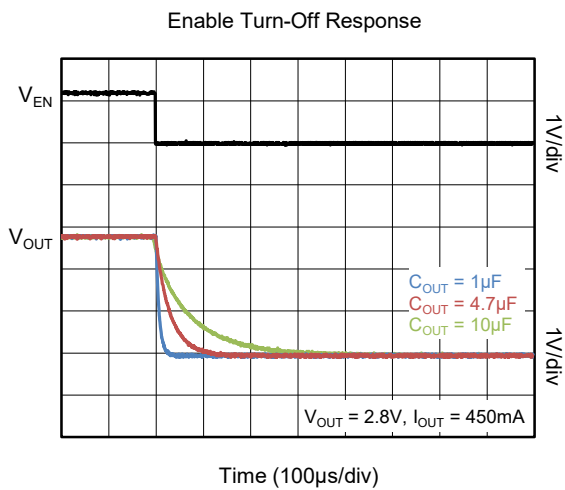
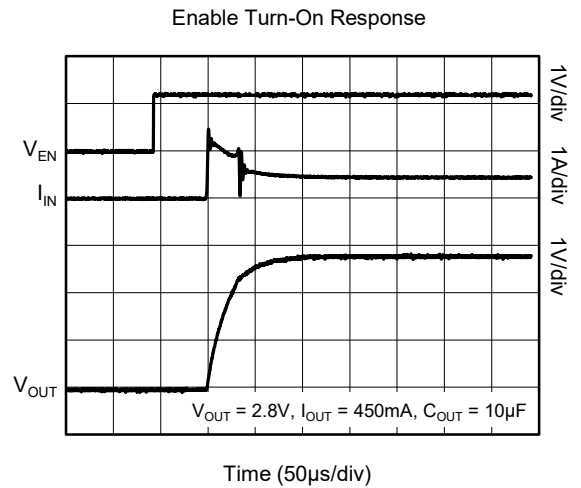
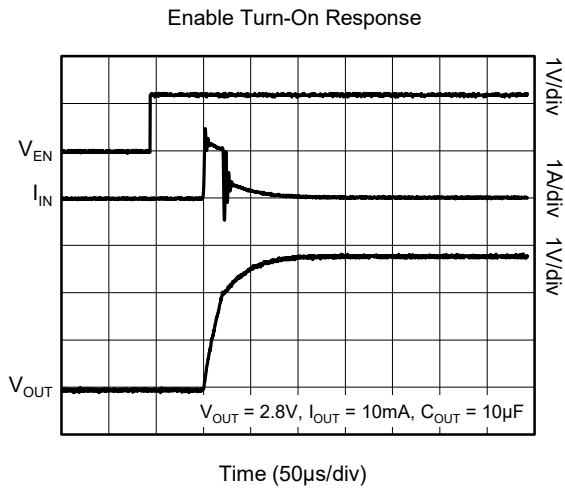
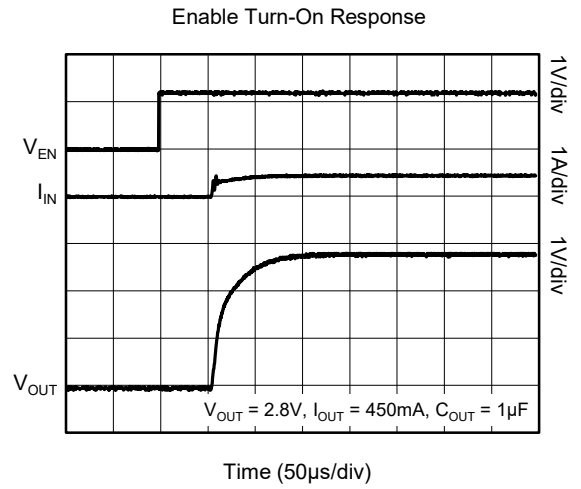
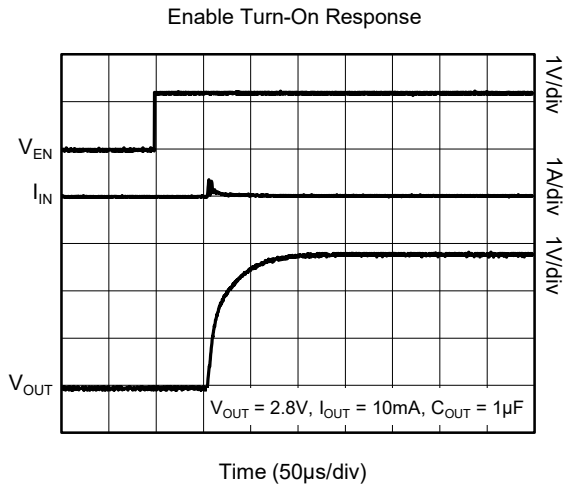

**TYPICAL PERFORMANCE CHARACTERISTICS (continued)**

$T_J = +25^\circ\text{C}$ ,  $V_{IN} = V_{OUT(NOM)} + 1\text{V}$ ,  $V_{EN} = V_{IN}$ ,  $C_{IN} = C_{OUT} = 1\mu\text{F}$ , unless otherwise noted.

Line Transient Response

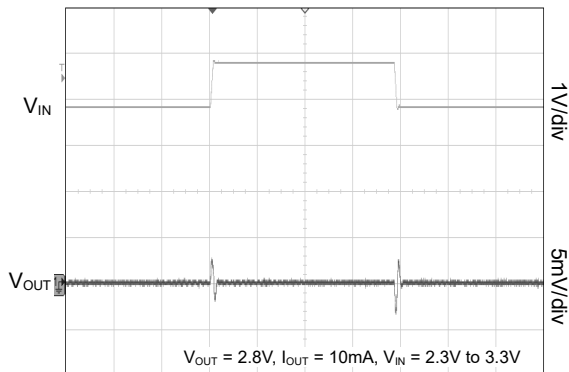

Time (20µs/div)

Line Transient Response

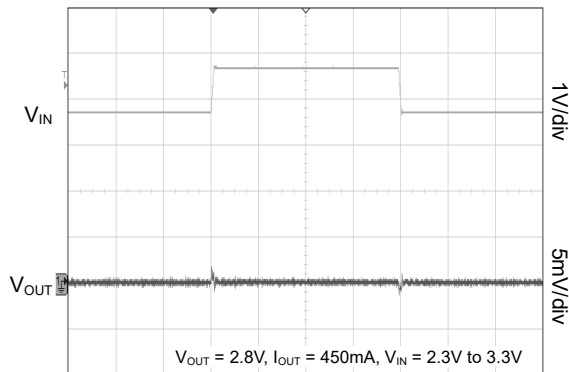

Time (20µs/div)

Load Transient Response

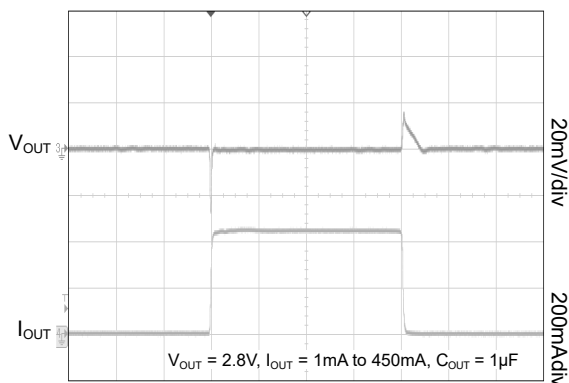

Time (20µs/div)

Load Transient Response

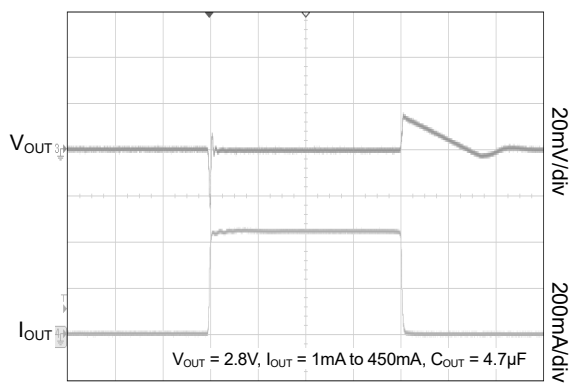

Time (20µs/div)



FUNCTIONAL BLOCK DIAGRAM

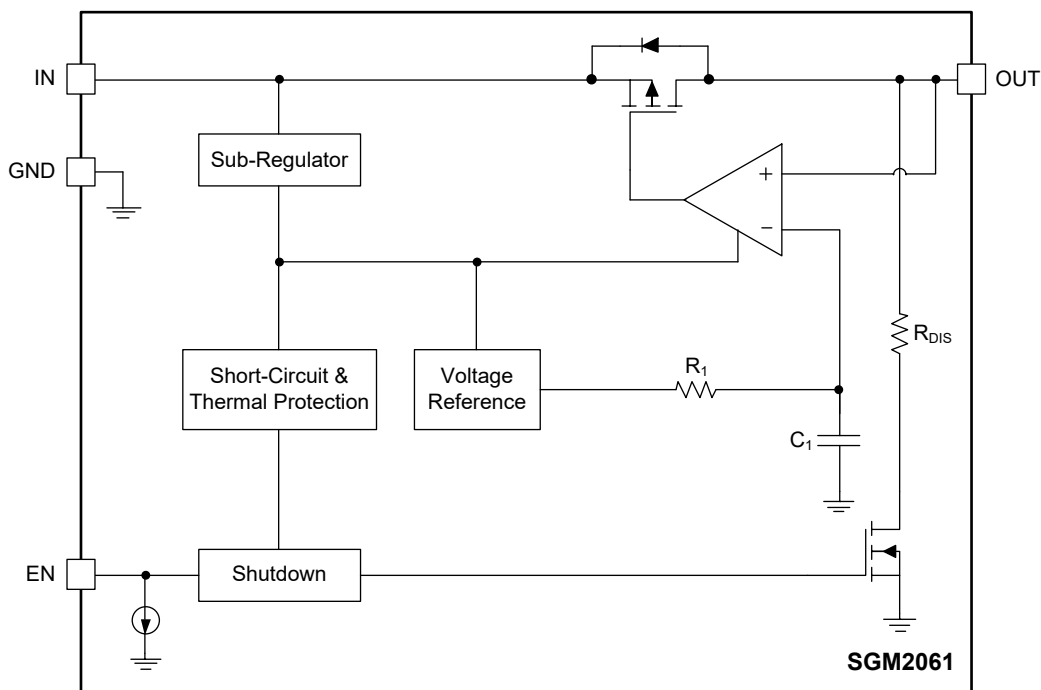

Figure 2. Block Diagram

### APPLICATION INFORMATION

The SGM2061 is an ultra-low noise and low dropout LDO and provides 450mA output current. These features make the device a reliable solution to solve many challenging problems in the generation of clean and accurate power supply. The high performance also makes the SGM2061 useful in a variety of applications. The SGM2061 provides the protection function for output overload, output short-circuit condition and overheating.

The SGM2061 provides an EN pin as an external chip enable control to enable/disable the device. When the regulator is in shutdown state, the shutdown current consumes as low as 0.03 $\mu$ A (TYP).

#### Input Capacitor Selection ( $C_{IN}$ )

The input decoupling capacitor should be placed as close as possible to the IN pin for ensuring the device stability. 1 $\mu$ F or larger X7R or X5R ceramic capacitor is selected to get good dynamic performance.

When  $V_{IN}$  is required to provide large current instantaneously, a large effective input capacitor is required. Multiple input capacitors can limit the input tracking inductance. Adding more input capacitors is available to restrict the ringing and to keep it below the device absolute maximum ratings.

#### Output Capacitor Selection ( $C_{OUT}$ )

The output decoupling capacitor should be placed as close as possible to the OUT pin. 1 $\mu$ F or larger X7R or X5R ceramic capacitor is selected to get good dynamic performance. The minimum effective capacitance of  $C_{OUT}$  that SGM2061 can remain stable is 0.5 $\mu$ F. For ceramic capacitor, temperature, DC bias and package size will change the effective capacitance, so enough margin of  $C_{OUT}$  must be considered in design. Additionally,  $C_{OUT}$  with larger capacitance and lower ESR will help increase the high frequency PSRR and improve the load transient response.

#### Enable Control

The EN pin of the SGM2061 is used to enable/disable its device and to deactivate/activate the output automatic discharge function.

When the EN pin voltage is lower than 0.6V, the device is in shutdown state, there is no current flowing from IN to OUT pins. In this state, the automatic discharge transistor is active to discharge the output voltage through a 270 $\Omega$  (TYP) resistor.

When the EN pin voltage is higher than 1V, the device is in active state, the input voltage is regulated to the output voltage and the automatic discharge transistor is turned off.

The EN pin is pulled down by internal 0.03 $\mu$ A (TYP) current source when the EN pin is floated. This current source will ensure the SGM2061 in shutdown state and reduce the power dissipation in system.

#### Reverse Current

The pass transistor has an inherent body diode which will be forward biased in the case when  $V_{OUT} > (V_{IN} + 0.3V)$ . If extended reverse voltage operation is anticipated, external limiting might be appropriate.

#### Negatively Biased Output

When the output is negative voltage, the chip may not start up due to parasitic effects. Ensure that the output is greater than -0.3V under all conditions. If excessive negatively biased output is expected in the application, a Schottky diode can be added between the OUT pin and GND pin.

#### Output Current Limit and Short-Circuit Protection

When overload events happen, the output current is internally limited to 900mA (TYP). When the OUT pin is shorted to ground, the short-circuit protection will limit the output current to 500mA (TYP).

#### Thermal Shutdown

The SGM2061 can detect the temperature of die. When the die temperature exceeds the threshold value of thermal shutdown, the SGM2061 will be in shutdown state and it will remain in this state until the die temperature decreases to +140°C.

**APPLICATION INFORMATION (continued)**

**Power Dissipation (P<sub>D</sub>)**

Thermal protection limits power dissipation in the SGM2061. When power dissipation on pass element (P<sub>D</sub> = (V<sub>IN</sub> - V<sub>OUT</sub>) × I<sub>OUT</sub>) is too much and the operating junction temperature exceeds +160°C, the OTP circuit starts the thermal shutdown function and turns the pass element off.

Therefore, thermal analysis for the chosen application is important to guarantee reliable performance over all conditions. To guarantee reliable operation, the junction temperature of the SGM2061 must not exceed +125°C.

The maximum allowable power dissipation depends on the thermal resistance of the IC package, the PCB layout, the rate of surrounding airflow, and the difference between the junction temperature and ambient temperature. The maximum power dissipation can be approximated using the following equation:

$$P_{D(MAX)} = (T_{J(MAX)} - T_A) / \theta_{JA} \quad (1)$$

where T<sub>J(MAX)</sub> is the maximum junction temperature, T<sub>A</sub> is the ambient temperature, and θ<sub>JA</sub> is the junction -to-ambient thermal resistance.

**REVISION HISTORY**

NOTE: Page numbers for previous revisions may differ from page numbers in the current version.

| OCTOBER 2021 – REV.A to REV.A.1                           | Page |
|---|------|
| Updated Electrical Characteristics section .....          | 4    |
| Updated Typical Performance Characteristics section ..... | 5    |
| Changes from Original (SEPTEMBER 2021) to REV.A           | Page |
| Changed from product preview to production data .....     | All  |

PACKAGE OUTLINE DIMENSIONS

WLCSP-0.64x0.64-4B-A

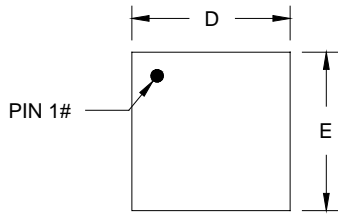

TOP VIEW

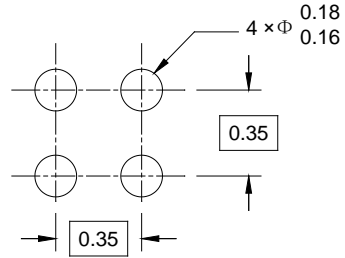

RECOMMENDED LAND PATTERN (Unit: mm)

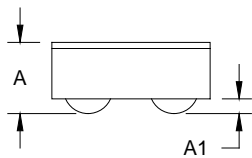

SIDE VIEW

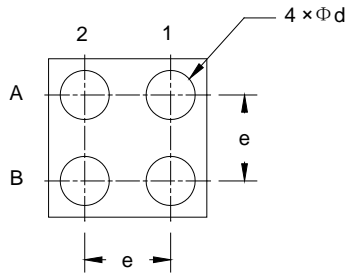

BOTTOM VIEW

| Symbol | Dimensions In Millimeters |       |       |
|--------|---------------------------|-------|-------|
|        | MIN                       | MOD   | MAX   |
| A      | 0.262                     | 0.290 | 0.318 |
| A1     | 0.050                     | 0.060 | 0.070 |
| D      | 0.620                     | 0.645 | 0.670 |
| E      | 0.620                     | 0.645 | 0.670 |
| d      | 0.190                     | 0.200 | 0.210 |
| e      | 0.350 BSC                 |       |       |

NOTE: This drawing is subject to change without notice.

# PACKAGE INFORMATION

## TAPE AND REEL INFORMATION

### REEL DIMENSIONS



### TAPE DIMENSIONS



NOTE: The picture is only for reference. Please make the object as the standard.

### KEY PARAMETER LIST OF TAPE AND REEL

| Package Type         | Reel Diameter | Reel Width W1 (mm) | A0 (mm) | B0 (mm) | K0 (mm) | P0 (mm) | P1 (mm) | P2 (mm) | W (mm) | Pin1 Quadrant |
|----------------------|---------------|--------------------|---------|---------|---------|---------|---------|---------|--------|---------------|
| WLCSP-0.64×0.64-4B-A | 7"            | 9.5                | 0.74    | 0.74    | 0.37    | 4.0     | 4.0     | 2.0     | 8.0    | Q1            |

DD0001

# PACKAGE INFORMATION

## CARTON BOX DIMENSIONS



NOTE: The picture is only for reference. Please make the object as the standard.

## KEY PARAMETER LIST OF CARTON BOX

| Reel Type   | Length (mm) | Width (mm) | Height (mm) | Pizza/Carton |
|-------------|-------------|------------|-------------|--------------|
| 7" (Option) | 368         | 227        | 224         | 8            |
| 7"          | 442         | 410        | 224         | 18           |

DD0002