

标记	修改内容	日期	版本	设计者
①				
②				
③				

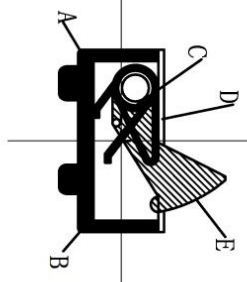
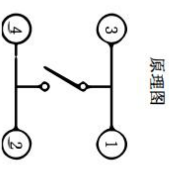
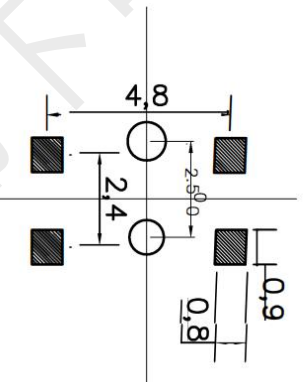
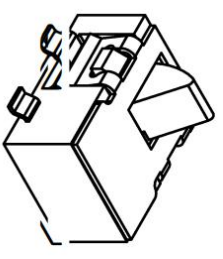
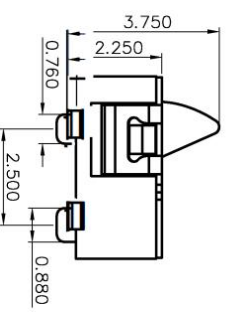
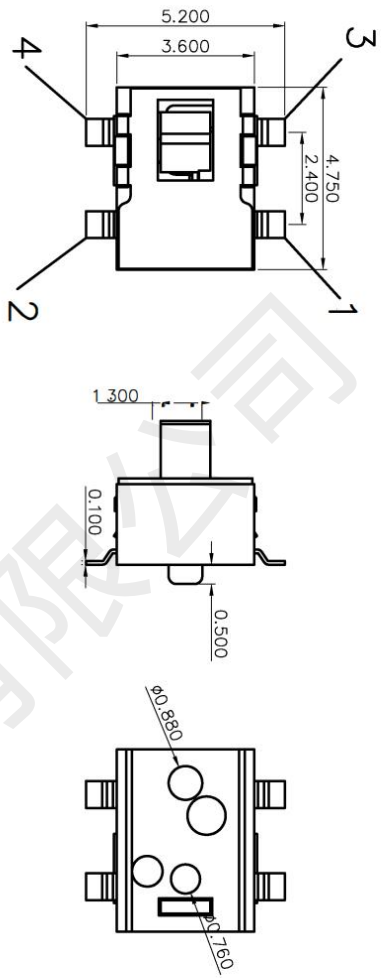

NO.	零件名称 Part Name	材料 Material	QTY	材料 Material	镀涂 Plating coating	颜色 colour	备注 Remarks
E	按钮	进口增强尼龙	1		/	黑色	
D	盖板	SUS301-H T=0.15	1	整体清洗	镀银	银白色	
C	接触弹簧	进口磷青铜	1	镀银	镀银	银白色	
B	嵌件	进口磷青铜	1			银白色	
A	底座/基座	进口 LCP	1		/	黑色	

项目	标准
额定电流 Rated Current:	50mA MAX
额定电压 Rated voltage:	DC 12V
接触电阻 Contact resistance:	≤150mΩ
绝缘电阻 Insulation Resistance:	≥100MΩ
耐压强度 Compressive strength:	AC250V 50Hz/1 min
操作力度 Operating force:	30±20gf
机械寿命 Mechanical life:	100,000 cycles Min
操作行程 Operation Stroke:	0.3+0.2mm
环境温度 Temperature Range:	-30°C ~ +85°C

公差	角度公差
未注公差 GENERAL TOLERANCE	ANGLE TOLERANCE
.X	X°
.XX	XX°
.XXX	.XXX

单位: mm (DIMENS)	产品系列: 检测开关 (Prod use series)
材料: XXXXXXXXX (MATERIAL)	成品料号: HX TS-103 (P (APT NO))
热处理: 00-00° (HT) HRC	零件名: XXXXXXXXX (TITLE)
数量: 400PCS (QTY)	零件号: 00-00 (DWG NO)
图号: XX000-XXXXX-XX000 (DRAWING NO)	

视图 (VIEW)	比例 (SCALE)	设计 (DR)
数量 (PAGE) 00-00	图纸 (SIZE) A4	李春风
版本 (REV) A00	校对 (CHKD) 钟华华	2021.6.21
	核准 (APPD) 罗孝金	2021.6.21

韩下
 深圳市韩下电子有限公司



深圳市韩下电子有限公司

Shenzhen Hanxia Electronic Co., Ltd
Tel: 0755-33819206 Fax: 0755-27597491

承 认 书

SPECIFICATION FOR APPROVAL

客 户 Customer:

产品名称 Project:

检测开关

规格型号 Part No:

HX TS-103

贵公司承认印 Approval signatures

料 号/Part No.	签 章/Signatures

日期 Date:

拟制/Drawn	李春风	
审核/Check	钟华华	
批准/Approved	罗孝金	



规格书 SPECIFICATION

1. 一般特性 General Characteristics

- 1.1 额定值(Rating Value): DC 12V 50mA
- 1.2 工作温度(Work Temperature Range): $-30^{\circ}\text{C} \sim 85^{\circ}\text{C}$
- 1.3 存储温度(Store Temperature Range): $-20^{\circ}\text{C} \sim 80^{\circ}\text{C}$
- 1.4 正常测试条件(未有特殊说明量测在以下条件进行):

General test condition (Tests and measurements shall be made under the following standard conditions unless otherwise specified):

正常温度: $5^{\circ}\text{C} \sim 35^{\circ}\text{C}$ 相对湿度: 45%~85% RH 气压: 8,600~10,600 帕
Temperature: $5^{\circ}\text{C} \sim 35^{\circ}\text{C}$ Relative humidity: 45%~85% Air pressure: 8,600~10,600 pa

2. 产品外观及尺寸要求 Appearance & Dimension Requirement

- 2.1 产品外形结构紧凑,无配合不良。
The structure of product is compact, and assembly of parts has no badness.
- 2.2 产品塑胶部件无严重缩水、披锋、欠注、斑点、破损或变形现象。
The plastic parts of product have no serious defects such as very serious shrink, scarcity, fleck, disrepair, transmutation, etc.
- 2.3 产品引脚和外壳无严重氧化、脏污、变形、毛刺或电镀不良。
Lead feet and shell have no serious defects such as oxidation, smudge, disrepair, burr, defects on plating.
- 2.4 开关操作顺畅,节奏感强,无明显卡塞现象。
Operating switch is unhindered, rhythmmed, and there is not palpable clag.
- 2.5 产品结构及尺寸参见产品规格图纸。
Construction and dimensions: Refer to individual product drawing.

3. 电气特性 Electronic Characteristics

No.	项目 Item	测试方法 Test Method	测试设备 Equipment	特性要求 Requirements
3.1	接触电阻 Contact Resistance	在低电流 ($\leq 100\text{mA}$) 条件下测试。 Measured at low current (100mA or less).	低电阻测试仪 Low Resistance Meter	$150\text{m}\Omega$ MAX
3.2	绝缘阻抗 Insulation Resistance	测试相邻引脚之间,引脚与外壳之间的绝缘阻抗。 Measurement shall be made between adjacent terminals, between terminal and shell.	绝缘测试机 Insulation Resistance Tester	$100\text{M}\Omega$ MIN
3.3	耐压测试 Dielectric Withstand Voltage	输入一定电压 (50~60Hz, 电压值 AC 250V) 1 分钟,漏电流为 2mA, 测试邻近端子间。 Apply certain voltage (50~60Hz, AC 250V) for 1 minute between adjacent contacts of the connector with 2mA leakage sensitivity.	耐压测试机 Puncture Tester	没有绝缘破坏。 电弧等异常。 No arcing, break down and damaging insulation.

4. 机械特性 Mechanical Characteristics

No.	项目 Item	测试方法 Test Method	测试设备 Equipment	特性要求 Requirements
4.1	操作力 Operation Force	<p>逐渐施力操作开关按键，测量开关到达全部工作行程时所需的最大操作力度。</p> <p>Operate the keystroke of the switch and then increase press strength gradually, Measured maximum operation force while the travel of the switch is full.</p>	测力计 Force Gauge	30±20gf

5. 可靠性测试 Reliability trial

No.	项目 Item	测试方法 Test Method	测试设备 Equipment	特性要求 Requirements
5.1	可焊性试验 Solder ability Test	<p>端子顶部被浸入焊锡炉中，温度为 260±5℃，时间 5±1 秒。</p> <p>The top of the terminals shall be dipped in the solder bath at 260±5℃ for 5±1 seconds.</p>	控温锡炉 Solder Stove	<p>引脚至少 95%上锡。</p> <p>Ninety-five percent of terminals shall be dipped.</p>
5.2	寿命试验 Operation Life	<p>开关在寿命试验设备上以约 90 次 / 分的速度连续被操作，具体次数见规格图示。</p> <p>Switch shall be operated continuously at about 90 cycles /min without load.</p>	寿命试验机 Life Tester	<p>寿命:100000 次</p> <p>实验后:</p> <p>绝缘电阻: 10MΩ Min</p> <p>操作力: 变化在±50%内开关外观及结构无损坏。</p> <p>Life test:100000 cycles</p> <p>After test, Insulation resistance:10MΩ Min</p> <p>Operating force: Change should be within ±50% of specified value.</p> <p>No abnormalities shall be recognized in appearance and construction.</p>
5.3	耐焊接热 Resistance to Soldering heat	<p>端子焊接部分浸入焊炉，焊炉温度 260± 5℃，焊接时间 5±1 秒。(焊接时不可于端子施加外力)。</p> <p>Terminals shall be dipped in the solder bath at 260±5℃ for 5±1 seconds without additional force for terminals.</p>	控温锡炉 Solder Stove	<p>本体无变形，能满足于机械、电气性能。</p> <p>Appearance should be not damaged, electrical and mechanical characteristics shall be satisfied.</p>

5. 可靠性测试 Reliability trial

No.	项目 Item	测试方法 Test Method	测试设备 Equipment	特性要求 Requirements
5.4	耐高温测试 Resistance to Heat Test	放置在温度 $80\pm 2^{\circ}\text{C}$ 环境中 96 小时后，再置于正常条件下 1 小时后测定。 The switch shall be stored at a temperature of $80\pm 2^{\circ}\text{C}$ for 96 hours, Measurements shall be made after it be subjected to the standard conditions for 1 hour.	高低温试验机 High & Low Temperature Tester	外观，机械及电气性能均符合要求。 Appearance, electrical and mechanical characteristics shall be satisfied.
5.5	耐低温测试 Resistance to Cold Test	放置在温度 $-20\pm 2^{\circ}\text{C}$ 环境中 96 小时后，再置于正常条件下 1 小时后测定。 The switch shall be stored at a temperature of $-20\pm 2^{\circ}\text{C}$ for 96 hours, Measurements shall be made after it be subjected to the standard conditions for 1 hour.	高低温试验机 High & Low Temperature Tester	外观，机械及电气性能均符合要求。 Appearance, electrical and mechanical characteristics shall be satisfied.
5.6	耐湿性测试 Resistance to Humidity Test	放置于温度 $40\pm 2^{\circ}\text{C}$ ，相对湿度为 90~96% 环境中 96 小时后，再置于正常条件下 1 小时后测定(注意要擦去水滴)。 The switch shall be stored at a temperature of $40\pm 2^{\circ}\text{C}$, relative humidity 90~96% for 96 hours, Measurements shall be made after it be subjected to the standard conditions for 1 hour (Wipe out water drip).	恒温恒湿箱 Temperature & Humidity Tester Chamber	外观，机械及电气性能均符合要求。 Appearance, electrical and mechanical characteristics shall be satisfied.
5.7	盐雾实验 Salt Mist Test	试件在下述实验后测量： 1. 温度： $35\pm 5^{\circ}\text{C}$ 2. 盐溶液浓度： $5\pm 1\%$ (质量百分比)， 3. 试验时间：24 小时， 4. 试验后，将盐沉积物用水冲掉。 The switch shall be checked after following test: 1. Temperature: $35\pm 5^{\circ}\text{C}$ 2. Salt solution: $5\pm 1\%$ (Solids by mass) 3. Duration: 24 hours, 4. After immersing, salt deposit shall be removed by running water.	盐雾试验机 Salt Spray Tester	在金属件上没有严重腐蚀斑点。 No remarkable corrosion shall be recognized in metal parts.