

Product Summary

- 20V/-7 A
- $R_{DS(ON)} = 22m\Omega(Typ.)@V_{GS}=-4.5V$
- $R_{DS(ON)} = 26m\Omega(Typ.)@V_{GS}=-2.5V$

Application

- Battery Pack
- Portable Devices

Package and Pin Configuration

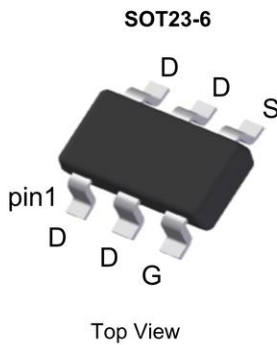

Circuit diagram

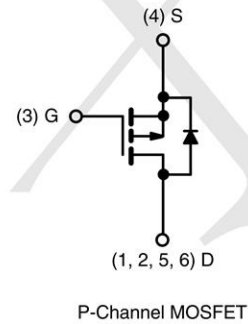

Marking:

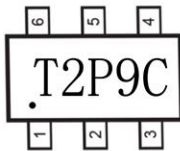

Absolute Maximum Ratings ($T_A=25^\circ C$ unless otherwise noted)

| PARAMETER | SYMBOL | LIMIT | UNIT |
|--|----------------|---------------------|------------|
| Drain-Source Voltage | V_{DS} | -20 | V |
| Gate-Source Voltage | V_{GS} | ± 12 | V |
| Continuous Drain Current | I_D | $T_C = 25^\circ C$ | -7 |
| | | $T_C = 100^\circ C$ | -4.9 |
| Pulsed Drain Current ^(Note 1) | I_{DM} | -26 | A |
| Total Power Dissipation | P_{DTOT} | 1.56 | W |
| Operating Junction Temperature | T_J | 150 | $^\circ C$ |
| Operating Junction and Storage Temperature Range | T_J, T_{STG} | - 55 to +150 | $^\circ C$ |

Thermal Characteristic

| PARAMETER | SYMBOL | LIMIT | UNIT |
|--|-----------------|-------|--------------|
| Junction to Ambient Thermal Resistance | $R_{\theta JA}$ | 80 | $^\circ C/W$ |

Electrical Characteristics ($T_A=25^\circ\text{C}$ unless otherwise noted)

| PARAMETER | CONDITIONS | SYMBOL | MIN | TYP | MAX | UNIT |
|----------------------------------|--|--------------|------|------|-----------|------------|
| Static (Note 2) | | | | | | |
| Drain-Source Breakdown Voltage | $V_{GS} = 0V, I_D = -250\mu A$ | BV_{DSS} | -20 | -- | -- | V |
| Gate Threshold Voltage | $V_{DS} = V_{GS}, I_D = -250\mu A$ | $V_{GS(TH)}$ | -0.4 | -- | -1.1 | V |
| Gate Body Leakage | $V_{GS} = \pm 12V, V_{DS} = 0V$ | I_{GSS} | -- | -- | ± 100 | nA |
| Zero Gate Voltage Drain Current | $V_{DS} = -20V, V_{GS} = 0V$ | I_{DSS} | -- | -- | -1 | μA |
| | $V_{DS} = -16V, T_J = 125^\circ\text{C}$ | | -- | -- | -10 | |
| Drain-Source On-State Resistance | $V_{GS} = -4.5V, I_D = -5A$ | $R_{DS(on)}$ | -- | 22 | 26 | m Ω |
| | $V_{GS} = -2.5V, I_D = -4A$ | | -- | 26 | 32 | |
| | $V_{GS} = -1.8V, I_D = -3A$ | | -- | 32 | 40 | |
| Forward Transconductance | $V_{DS} = -10V, I_S = -5A$ | g_{fs} | -- | 15 | -- | S |
| Dynamic (Note 3) | | | | | | |
| Total Gate Charge | $V_{DS} = -10V, I_D = -5A,$ $V_{GS} = -4.5V$ | Q_g | -- | 19.5 | -- | nC |
| Gate-Source Charge | | Q_{gs} | -- | 2 | -- | |
| Gate-Drain Charge | | Q_{gd} | -- | 3.6 | -- | |
| Input Capacitance | $V_{DS} = -15V, V_{GS} = 0V,$ $F = 1.0\text{MHz}$ | C_{iss} | -- | 1670 | -- | pF |
| Output Capacitance | | C_{oss} | -- | 220 | -- | |
| Reverse Transfer Capacitance | | C_{rss} | -- | 120 | -- | |
| Switching | | | | | | |
| Turn-On Delay Time | $V_{DD} = -10V, I_D = -1A,$ $V_{GS} = -4.5V,$ $R_{GEN} = 25\Omega$ | $t_{d(on)}$ | -- | 10.4 | -- | ns |
| Turn-On Rise Time | | t_r | -- | 37.5 | -- | |
| Turn-Off Delay Time | | $t_{d(off)}$ | -- | 89.1 | -- | |
| Turn-Off Fall Time | | t_f | -- | 24.6 | -- | |
| Source-Drain Diode | | | | | | |
| Forward Voltage | $V_{GS} = 0V, I_S = -1A$ | V_{SD} | -- | -- | -1 | V |
| Continuous Forward Current | Integral reverse diode in the MOSFET | I_S | -- | -- | -7 | A |
| Pulse Forward Current | | I_{SM} | -- | -- | -26 | A |

Typical Electrical and Thermal Characteristics

Continuous Drain Current vs. T_c

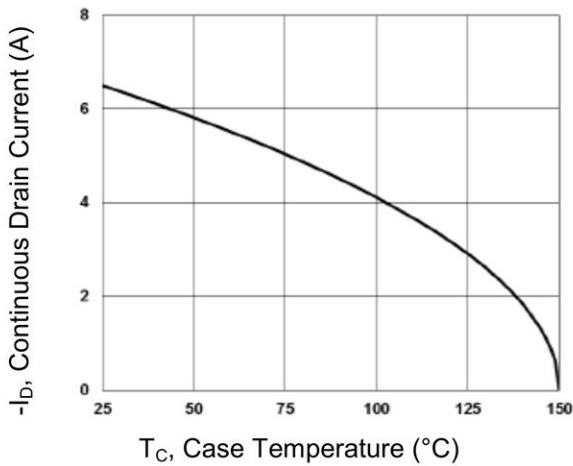

Gate Charge

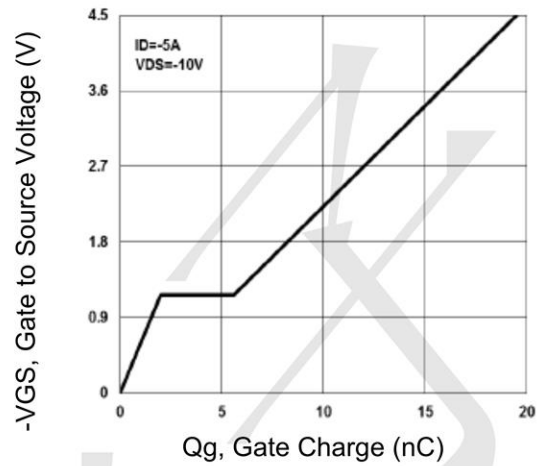

On-Resistance vs. Junction Temperature

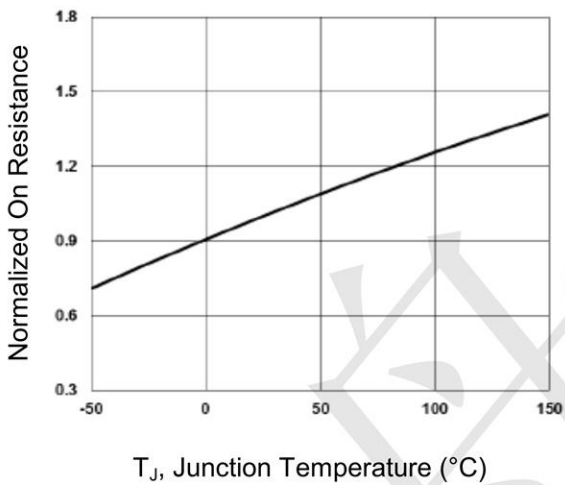

Threshold Voltage vs. Junction Temperature

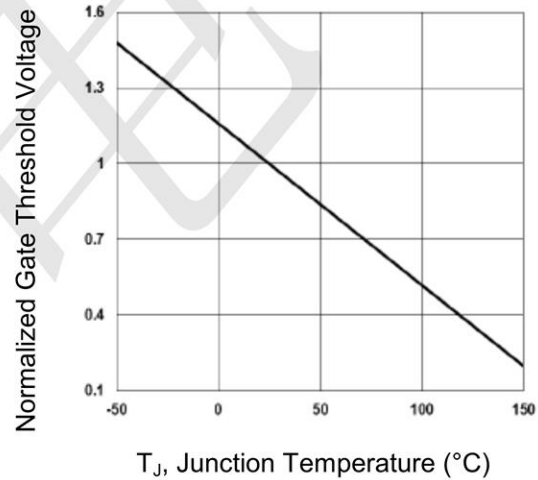

Maximum Safe Operating Area

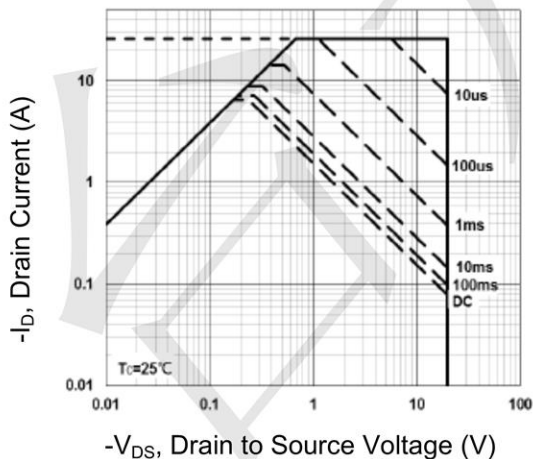

Normalized Thermal Transient Impedance Curve

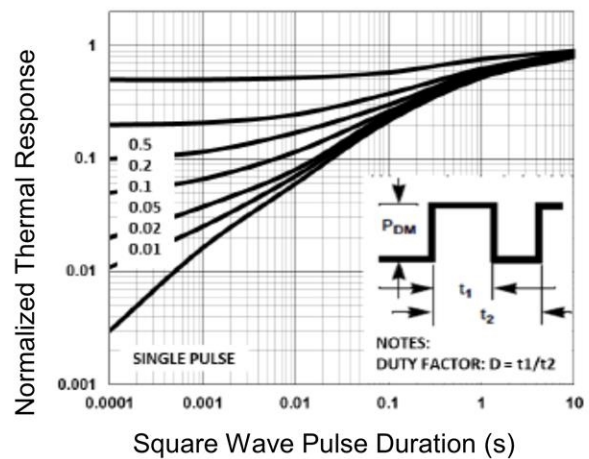



SOT23-6 Package Outline Dimensions

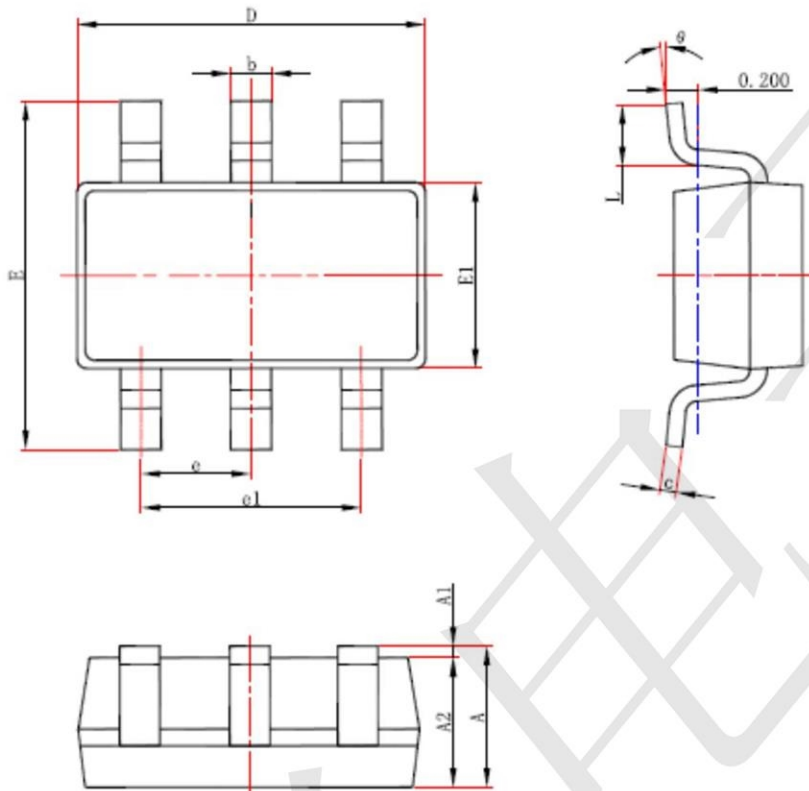

| Symbol | Dimensions In Millimeters | | Dimensions In Inches | |
|--------|---------------------------|-------|----------------------|-------|
| | Min. | Max. | Min. | Max. |
| A | 1.050 | 1.250 | 0.041 | 0.049 |
| A1 | 0.000 | 0.100 | 0.000 | 0.004 |
| A2 | 1.050 | 1.150 | 0.041 | 0.045 |
| b | 0.300 | 0.500 | 0.012 | 0.020 |
| c | 0.100 | 0.200 | 0.004 | 0.008 |
| D | 2.820 | 3.020 | 0.111 | 0.119 |
| E1 | 1.500 | 1.700 | 0.059 | 0.067 |
| E | 2.650 | 2.950 | 0.104 | 0.116 |
| e | 0.950(BSC) | | 0.037(BSC) | |
| e1 | 1.800 | 2.000 | 0.071 | 0.079 |
| L | 0.300 | 0.600 | 0.012 | 0.024 |
| θ | 0° | 8° | 0° | 8° |