

### Product Summary

- $V_{DS} = -30V, I_D = -2A$   
 $R_{DS(ON)} < 190m\Omega @ V_{GS} = -2.5V$   
 $R_{DS(ON)} < 330m\Omega @ V_{GS} = -4.5V$
- Package SOT-23

### Application

- Battery protection
- Load switch
- Power management

### Package and Pin Configuration

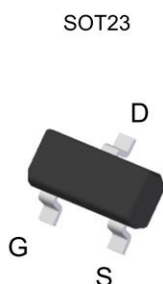

### Circuit diagram

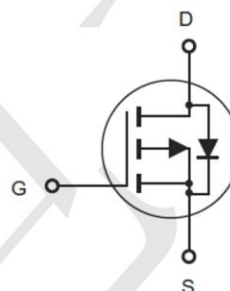

### Marking:



### Absolute Maximum Ratings ( $T_A = 25^\circ C$ unless otherwise noted)

| Parameter  | Symbol         | Limit      | Unit       |
|--|----------------|------------|------------|
| Drain-Source Voltage                             | $V_{DS}$       | -30        | V          |
| Gate-Source Voltage                              | $V_{GS}$       | $\pm 20$   | V          |
| Drain Current-Continuous                         | $I_D$          | -2         | A          |
| Drain Current -Pulsed <sup>(Note 1)</sup>        | $I_{DM}$       | -10        | A          |
| Maximum Power Dissipation                        | $P_D$          | 1          | W          |
| Operating Junction and Storage Temperature Range | $T_J, T_{STG}$ | -55 To 150 | $^\circ C$ |

### Thermal Characteristic

|   |                 |     |              |
|---|-----------------|-----|--------------|
| Thermal Resistance, Junction-to-Ambient <sup>(Note 2)</sup> | $R_{\theta JA}$ | 125 | $^\circ C/W$ |
|---|-----------------|-----|--------------|

**Electrical Characteristics ( $T_A=25^\circ\text{C}$  unless otherwise noted)**

| Parameter                                      | Symbol        | Test Condition  | Min  | Typ  | Max       | Units    |    |
|--|---------------|---|--|------|-----------|----------|----|
| <b>Static</b>                                  |               |   |  |      |           |          |    |
| Drain-Source Breakdown Voltage                 | $V_{(BR)DSS}$ | $V_{GS} = 0V, I_D = -250\mu A$  | -30  |      |           | V        |    |
| Gate-Source Threshold Voltage                  | $V_{GS(th)}$  | $V_{DS} = V_{GS}, I_D = -250\mu A$  | -1   | -1.6 | -3        |          |    |
| Gate-Source Leakage                            | $I_{GSS}$     | $V_{DS} = 0V, V_{GS} = \pm 20V$   |  |      | $\pm 100$ | nA       |    |
| Zero Gate Voltage Drain Current                | $I_{DSS}$     | $V_{DS} = -30V, V_{GS} = 0V$  |  |      | -1        | $\mu A$  |    |
| Drain-Source On-State Resistance <sup>a</sup>  | $R_{DS(on)}$  | $V_{GS} = -10V, I_D = -1.9A$  |  |      | 0.190     | $\Omega$ |    |
|  |               | $V_{GS} = -4.5V, I_D = -1.4A$   |  |      | 0.330     |          |    |
| Forward Transconductance <sup>a</sup>          | $g_{fs}$      | $V_{DS} = -5V, I_D = -1.9A$   | 1  |      |           | S        |    |
| <b>Dynamic<sup>b</sup></b>                     |               |   |  |      |           |          |    |
| Input Capacitance                              | $C_{iss}$     | $V_{DS} = -15V, V_{GS} = 0V, f = 1MHz$  |  | 155  |           | pF       |    |
| Output Capacitance                             | $C_{oss}$     |   |  | 35   |           |          |    |
| Reverse Transfer Capacitance                   | $C_{rss}$     |   |  | 25   |           |          |    |
| Total Gate Charge                              | $Q_g$         | $V_{DS} = -15V, V_{GS} = -10V, I_D = -1.9A$   |  | 4    | 8         | nC       |    |
|  |               | $V_{DS} = -15V, V_{GS} = -4.5V, I_D = -1.9A$  |  | 2    | 4         |          |    |
| Gate-Source Charge                             | $Q_{gs}$      | $V_{DS} = -15V, V_{GS} = -4.5V, I_D = -1.9A$  |  | 0.6  |           |          |    |
| Gate-Drain Charge                              | $Q_{gd}$      |   |  | 1    |           |          |    |
| Gate Resistance                                | $R_g$         | $f = 1MHz$  | 1.7  | 8.5  | 17        | $\Omega$ |    |
| Turn-On Delay Time                             | $t_{d(on)}$   | $V_{DD} = -15V,$<br>$R_L = 10\Omega, I_D = -1.5A,$<br>$V_{GEN} = -10V, R_g = 1\Omega$ |  | 4    | 8         | ns       |    |
| Rise Time                                      | $t_r$         |   |  | 11   | 18        |          |    |
| Turn-Off Delay Time                            | $t_{d(off)}$  |   |  | 11   | 18        |          |    |
| Fall Time                                      | $t_f$         |   |  | 8    | 16        |          |    |
| Turn-On Delay Time                             | $t_{d(on)}$   |   | $V_{DD} = -15V,$<br>$R_L = 10\Omega, I_D = -1.5A,$<br>$V_{GEN} = -4.5V, R_g = 1\Omega$ |      | 36        |          | 44 |
| Rise Time                                      | $t_r$         |   |  |      | 37        |          | 45 |
| Turn-Off Delay Time                            | $t_{d(off)}$  |   |  |      | 12        |          | 18 |
| Fall Time                                      | $t_f$         |   |  |      | 9         |          | 14 |
| <b>Drain-source Body diode characteristics</b> |               |   |  |      |           |          |    |
| Continuous Source-Drain Diode Current          | $I_S$         | $T_C = 25^\circ C$  |  |      | -2        | A        |    |
| Pulse Diode Forward Current <sup>a</sup>       | $I_{SM}$      |   |  |      | -10       |          |    |
| Body Diode Voltage                             | $V_{SD}$      | $I_S = -1.5A$   |  | -0.8 | -1.2      | V        |    |

Typical Electrical and Thermal Characteristics

Output Characteristics

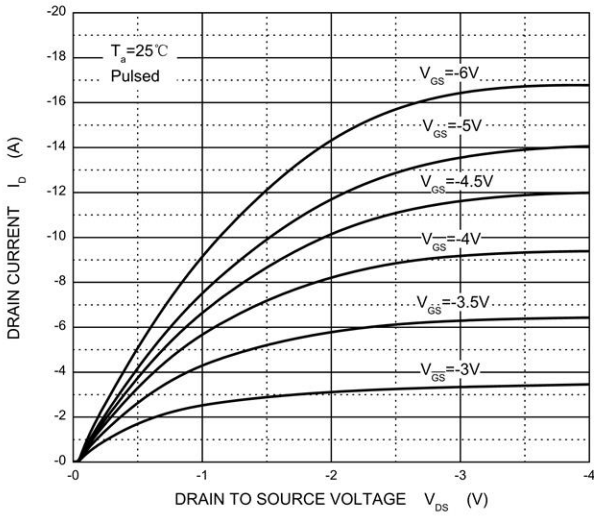

Transfer Characteristics

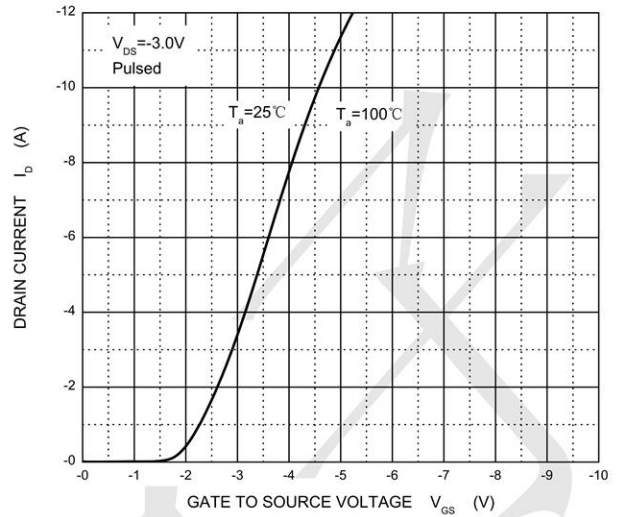

$R_{DS(ON)}$  —  $I_D$

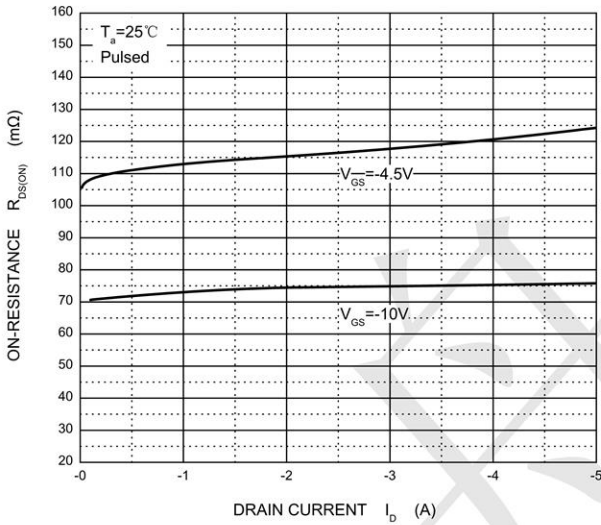

$R_{DS(ON)}$  —  $V_{GS}$

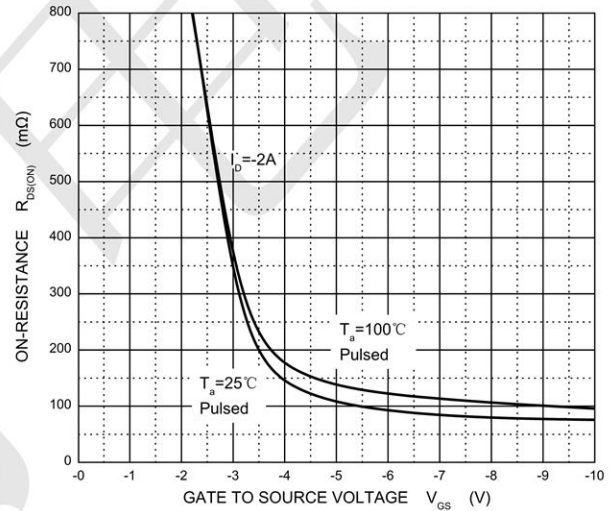

$I_S$  —  $V_{SD}$

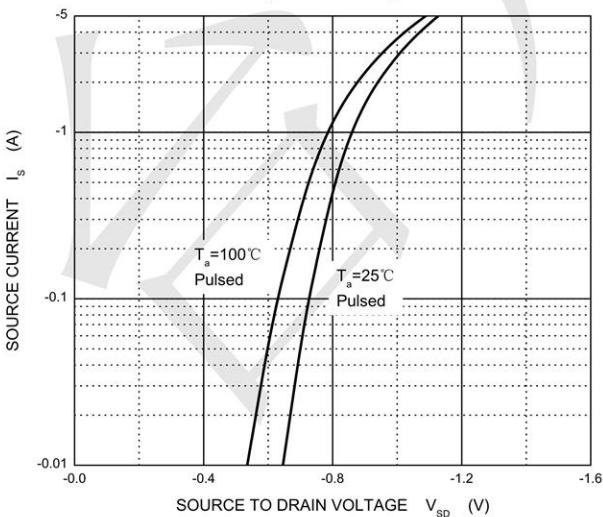

Threshold Voltage

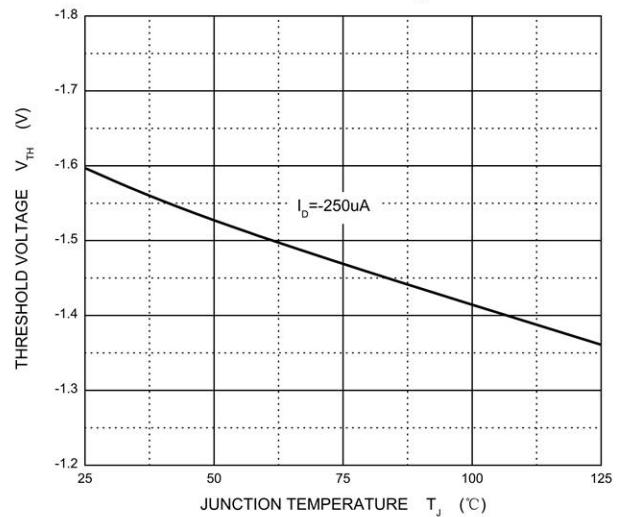

**SOT-23 Package Information**

(UNIT): mm

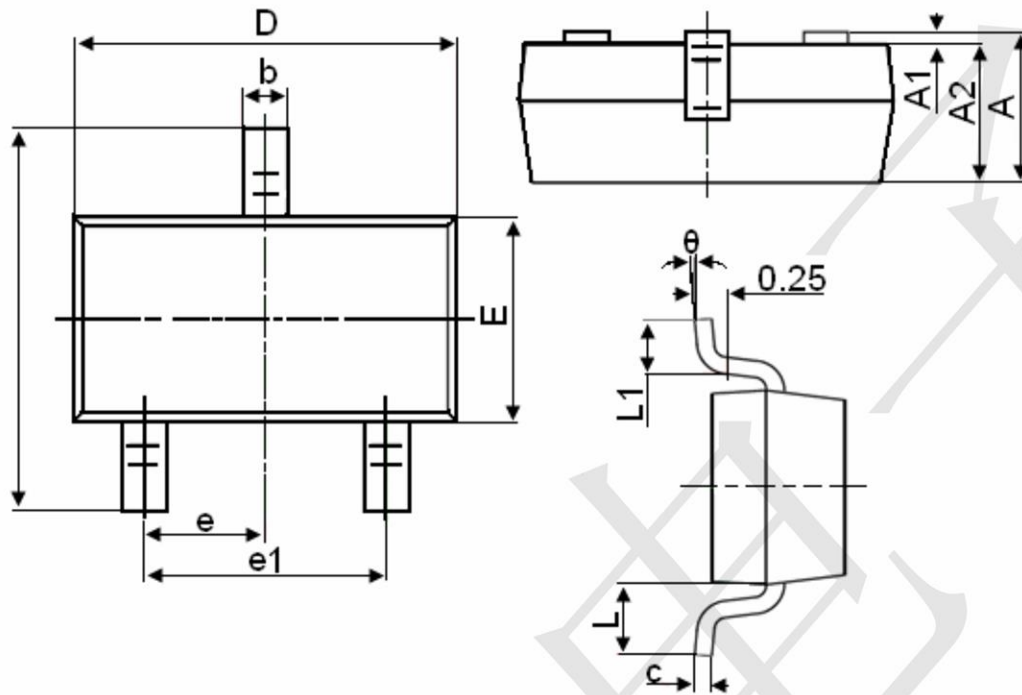

| Symbol | Dimensions in Millimeters |       |
|--------|---------------------------|-------|
|        | MIN.                      | MAX.  |
| A      | 0.900                     | 1.150 |
| A1     | 0.000                     | 0.100 |
| A2     | 0.900                     | 1.050 |
| b      | 0.300                     | 0.500 |
| c      | 0.080                     | 0.150 |
| D      | 2.800                     | 3.000 |
| E      | 1.200                     | 1.400 |
| E1     | 2.250                     | 2.550 |
| e      | 0.950TYP                  |       |
| e1     | 1.800                     | 2.000 |
| L      | 0.550REF                  |       |
| L1     | 0.300                     | 0.500 |
| θ      | 0°                        | 8°    |