

GENERAL DESCRIPTION

The SGM431V is a precision programmable shunt voltage reference that can be used in automotive applications. It is a three-terminal adjustable-output device that can keep stable under all capacitive loads. It requires two external resistors to set the output voltage from V_{REF} to 18V.

The SGM431V features low dynamic impedance, low noise, and low temperature coefficient to ensure a stable output voltage over a wide range of operating temperatures and currents. These high performances make it very suitable for multiple applications, such as precision audio components and flyback switching power supplies.

The SGM431V is available in a Green SOT-23 package.

FEATURES

- **Low Voltage Operation: Down to 1.24V**
- **Adjustable Output Voltage: V_{REF} to 18V**
- **Sink-Current Capability: 0.1mA to 70mA**
- **Reference Voltage Tolerance at +25°C:**
 - ◆ **SGM431VA: 1% (A Grade)**
 - ◆ **SGM431VB: 0.5% (B Grade)**
- **Temperature Drift: 2mV (TYP)**
- **Output Impedance: 0.1Ω (TYP)**
- **High Stability under Capacitive Load**
- **Low Output Noise**
- **Operating Junction Temperature Range: -40°C to +125°C**
- **Available in a Green SOT-23 Package**

APPLICATIONS

- Portable, Battery-Powered Equipment
- Voltage Monitoring
- Flyback Switching Power Supplies
- Instrumentation
- Product Testing
- Precision Audio Components

TYPICAL APPLICATION

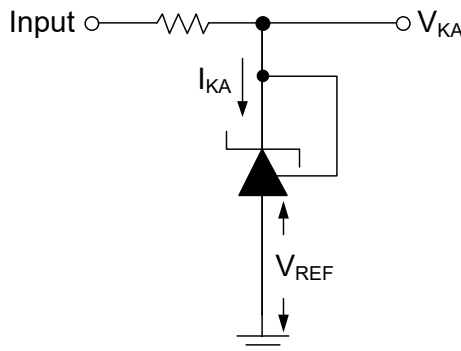

Figure 1. Typical Application Circuit

PACKAGE/ORDERING INFORMATION

MODEL	PACKAGE DESCRIPTION	SPECIFIED TEMPERATURE RANGE	ORDERING NUMBER	PACKAGE MARKING	PACKING OPTION
SGM431VA	SOT-23	-40°C to +125°C	SGM431VAXN3LG/TR	OR9XX	Tape and Reel, 3000
SGM431VB	SOT-23	-40°C to +125°C	SGM431VBXN3LG/TR	R9AXX	Tape and Reel, 3000

MARKING INFORMATION

NOTE: XX = Date Code.

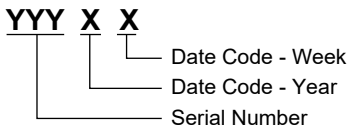

Green (RoHS & HSF): SG Micro Corp defines "Green" to mean Pb-Free (RoHS compatible) and free of halogen substances. If you have additional comments or questions, please contact your SGMICRO representative directly.

ABSOLUTE MAXIMUM RATINGS

- Cathode Voltage ⁽¹⁾, V_{KA}..... 20V
- Package Thermal Resistance
- SOT-23, θ_{JA} 290°C/W
- Junction Temperature +150°C
- Storage Temperature Range..... -65°C to +150°C
- Lead Temperature (Soldering, 10s) +260°C
- ESD Susceptibility
- HBM..... 8000V
- CDM 2000V

RECOMMENDED OPERATING CONDITIONS

- Cathode Voltage, V_{KA} V_{REF} to 18V
- Cathode Current, I_{KA}..... 0.1mA to 70mA
- Operating Junction Temperature Range..... -40°C to +125°C

NOTE:

1. All voltage values are with respect to ANODE, unless otherwise noted.

OVERSTRESS CAUTION

Stresses beyond those listed in Absolute Maximum Ratings may cause permanent damage to the device. Exposure to absolute maximum rating conditions for extended periods may affect reliability. Functional operation of the device at any conditions beyond those indicated in the Recommended Operating Conditions section is not implied.

ESD SENSITIVITY CAUTION

This integrated circuit can be damaged if ESD protections are not considered carefully. SGMICRO recommends that all integrated circuits be handled with appropriate precautions. Failure to observe proper handling and installation procedures can cause damage. ESD damage can range from subtle performance degradation to complete device failure. Precision integrated circuits may be more susceptible to damage because even small parametric changes could cause the device not to meet the published specifications.

DISCLAIMER

SG Micro Corp reserves the right to make any change in circuit design, or specifications without prior notice.

PIN CONFIGURATION

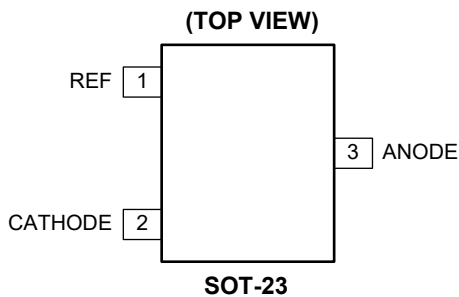

PIN DESCRIPTION

PIN	NAME	TYPE	DESCRIPTION
1	REF	I	REF Input Pin. Threshold Related to the voltage of ANODE Pin.
2	CATHODE	I/O	Cathode Pin. Voltage input and shunts current.
3	ANODE	O	Anode Pin. Connect to GND directly.

NOTE: I: input, O: output, I/O: input or output.

FUNCTIONAL BLOCK DIAGRAM

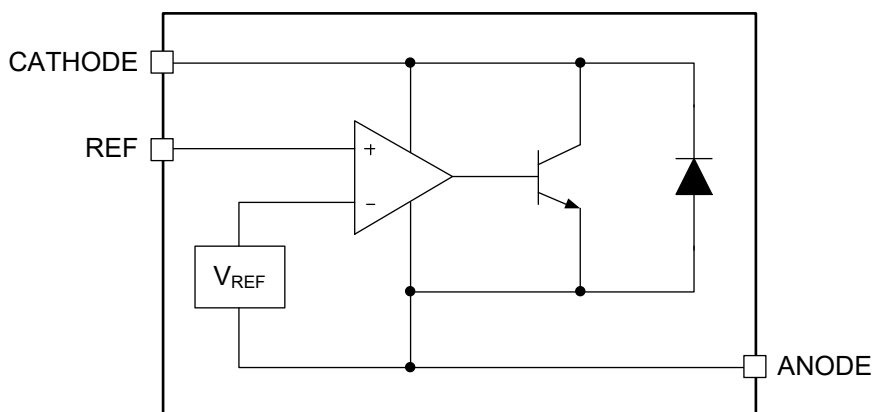

Figure 2. Equivalent Diagram

ELECTRICAL CHARACTERISTICS

(Over recommended operating conditions, T_J = +25°C, unless otherwise noted.)

PARAMETER	SYMBOL	CONDITIONS	MIN	TYP	MAX	UNITS	
SGM431VA							
Reference Voltage	V _{REF}	V _{KA} = V _{REF} , I _{KA} = 10mA	T _J = +25°C	1.228	1.240	1.252	V
			T _J = -40°C to +125°C	1.220		1.260	
Deviation of Reference Input Voltage over Full Temperature Range ⁽¹⁾	V _{I(DEV)}	V _{KA} = V _{REF} , I _{KA} = 10mA		2	10	mV	
Ratio of Change in Reference Voltage to the Change in Cathode Voltage	ΔV _{REF} /ΔV _{KA}	I _{KA} = 10mA, V _{KA} = V _{REF} to 18V		-0.1	-0.2	mV/V	
Reference Input Current	I _{REF}	I _{KA} = 10mA, R ₁ = 10kΩ, R ₂ = open		0.06	0.15	μA	
Deviation of Reference Input Current over Full Temperature Range ⁽¹⁾	I _{I(DEV)}	I _{KA} = 10mA, R ₁ = 10kΩ, R ₂ = open		0.15	0.5	μA	
Minimum Cathode Current for Regulation	I _{MIN}	V _{KA} = V _{REF}		65	80	μA	
Off-State Cathode Current	I _{K(OFF)}	V _{KA} = 18V, V _{REF} = 0V		0.01	0.1	μA	
Dynamic Impedance ⁽²⁾	Z _{KA}	V _{KA} = V _{REF} , f ≤ 1kHz, I _{KA} = 0.1mA to 70mA		0.1	0.3	Ω	
SGM431VB							
Reference Voltage	V _{REF}	V _{KA} = V _{REF} , I _{KA} = 10mA	T _J = +25°C	1.234	1.240	1.246	V
			T _J = -40°C to +125°C	1.225		1.255	
Deviation of Reference Input Voltage over Full Temperature Range ⁽¹⁾	V _{I(DEV)}	V _{KA} = V _{REF} , I _{KA} = 10mA		2	10	mV	
Ratio of Change in Reference Voltage to the Change in Cathode Voltage	ΔV _{REF} /ΔV _{KA}	I _{KA} = 10mA, V _{KA} = V _{REF} to 18V		-0.1	-0.2	mV/V	
Reference Input Current	I _{REF}	I _{KA} = 10mA, R ₁ = 10kΩ, R ₂ = open		0.06	0.15	μA	
Deviation of Reference Input Current over Full Temperature Range ⁽¹⁾	I _{I(DEV)}	I _{KA} = 10mA, R ₁ = 10kΩ, R ₂ = open		0.15	0.5	μA	
Minimum Cathode Current for Regulation	I _{MIN}	V _{KA} = V _{REF}		65	80	μA	
Off-State Cathode Current	I _{K(OFF)}	V _{KA} = 18V, V _{REF} = 0V		0.01	0.1	μA	
Dynamic Impedance ⁽²⁾	Z _{KA}	V _{KA} = V _{REF} , f ≤ 1kHz, I _{KA} = 0.1mA to 70mA		0.1	0.3	Ω	

NOTES:

1. V_{I(DEV)} and I_{I(DEV)} refer to the difference between the maximum value and the minimum value obtained within the rated temperature range. α_{VREF} is defined as:

$$|\alpha_{VREF}| \left(\frac{\text{ppm}}{^{\circ}\text{C}} \right) = \frac{\left(\frac{V_{I(DEV)}}{V_{REF \text{ at } 25^{\circ}\text{C}}} \right) \times 10^6}{\Delta T_J}$$

where,

ΔT_J is the rated operating junction temperature range of the device.

α_{VREF} is the average full-range temperature coefficient of the reference input voltage.

2. |Z_{KA}| = ΔV_{KA} / ΔI_{KA}, when the device is operating with two external resistors, the total dynamic impedance of the circuit is equal to |Z'| = ΔV / ΔI, which is approximately equal to |Z_{KA}| (1 + R₁ / R₂).

TYPICAL PERFORMANCE CHARACTERISTICS

T_J = +25°C, unless otherwise noted.

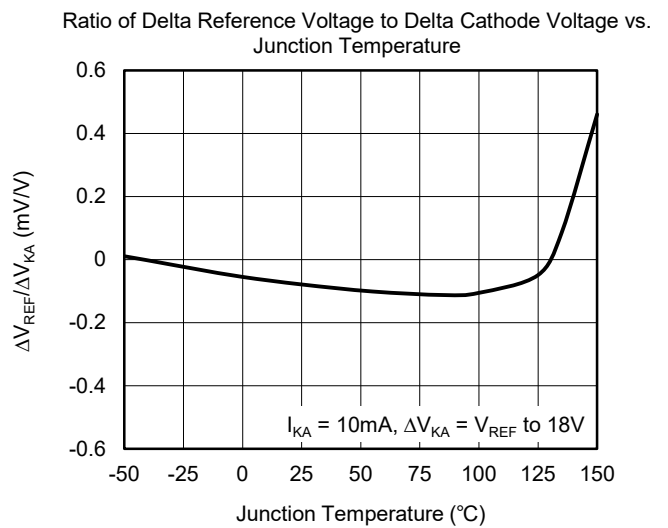
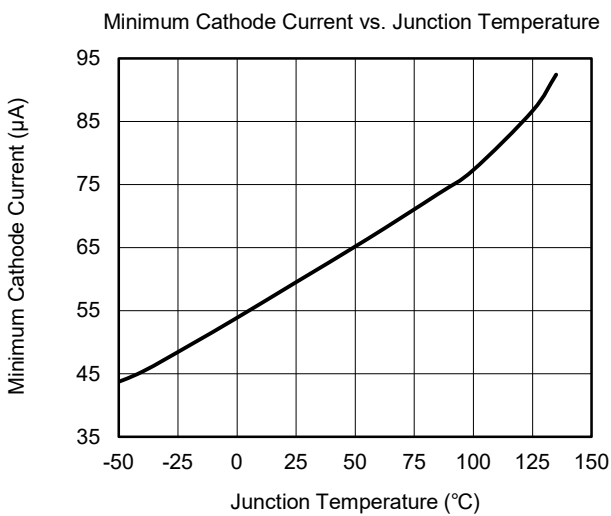
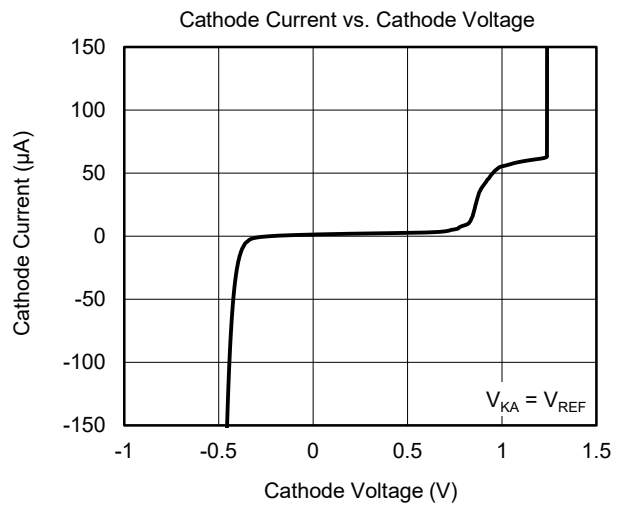
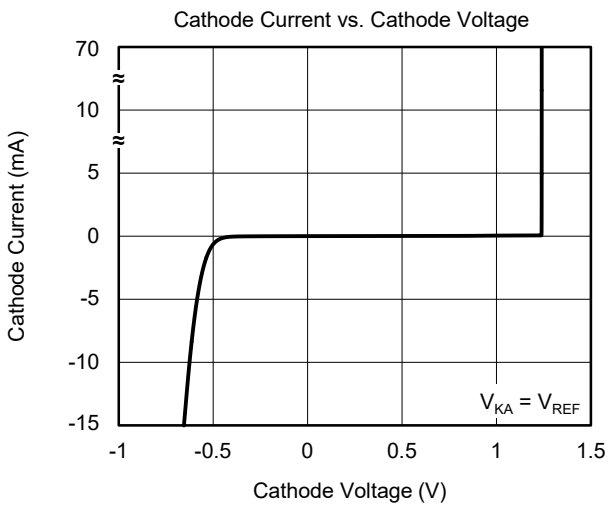
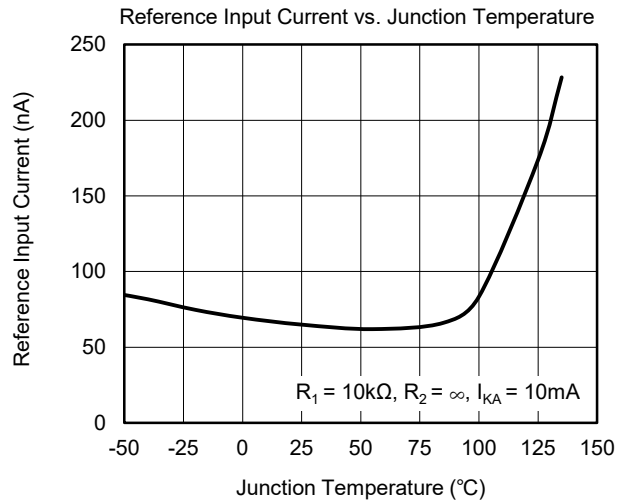
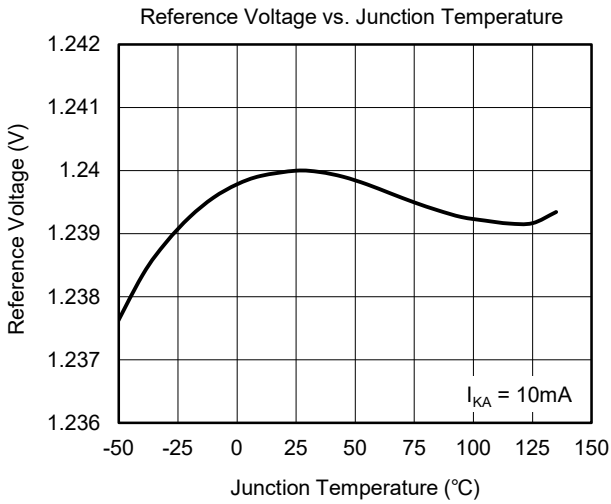

TYPICAL PERFORMANCE CHARACTERISTICS (continued)

T_J = +25°C, unless otherwise noted.

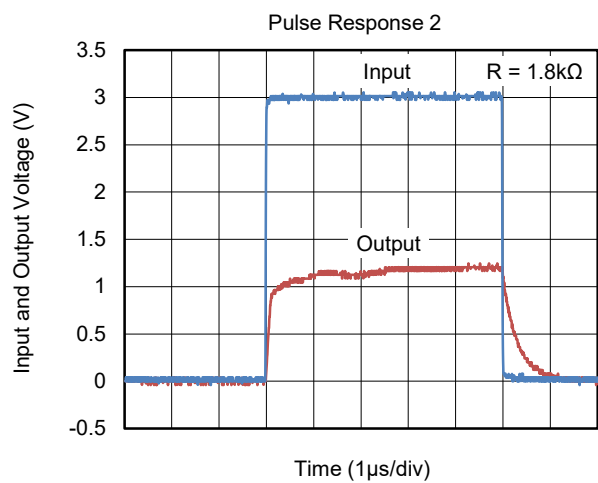
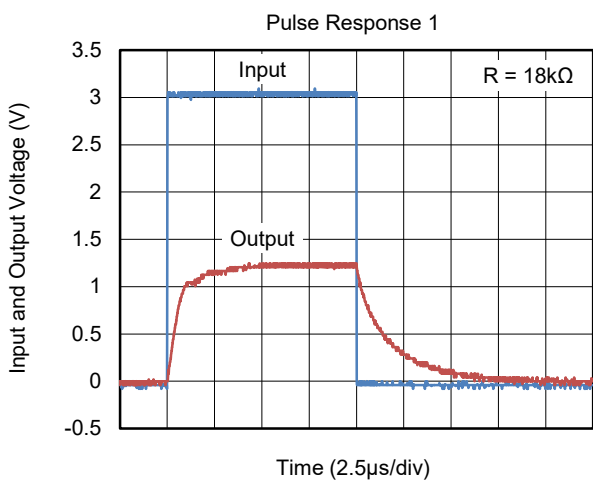
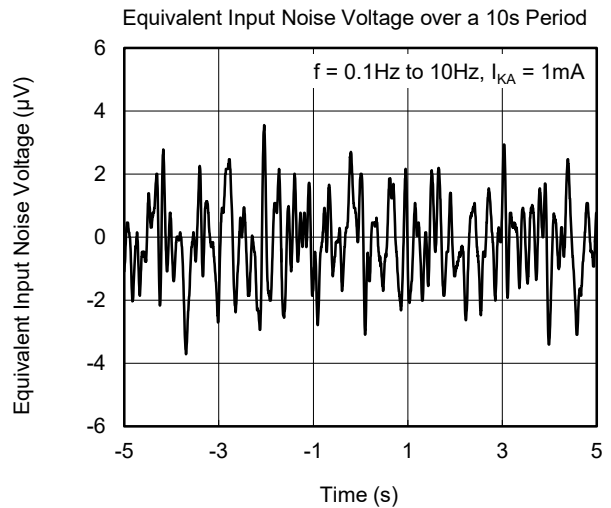
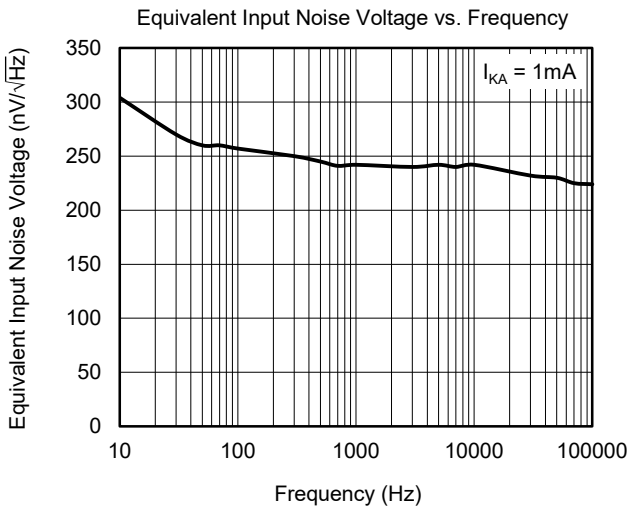
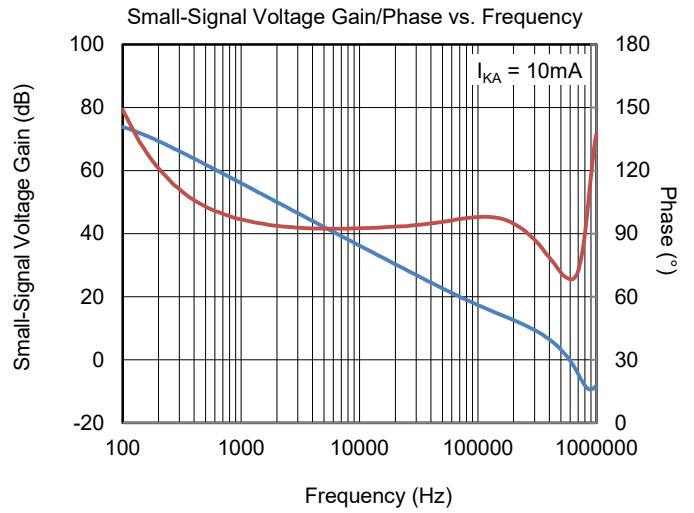
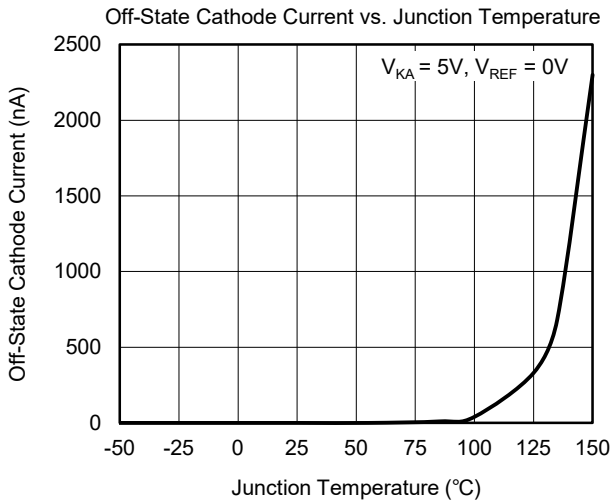

TYPICAL PERFORMANCE CHARACTERISTICS (continued)

T_J = +25°C, unless otherwise noted.

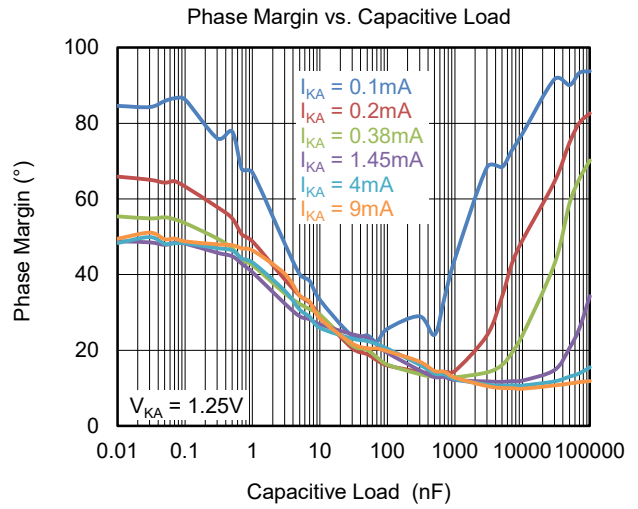
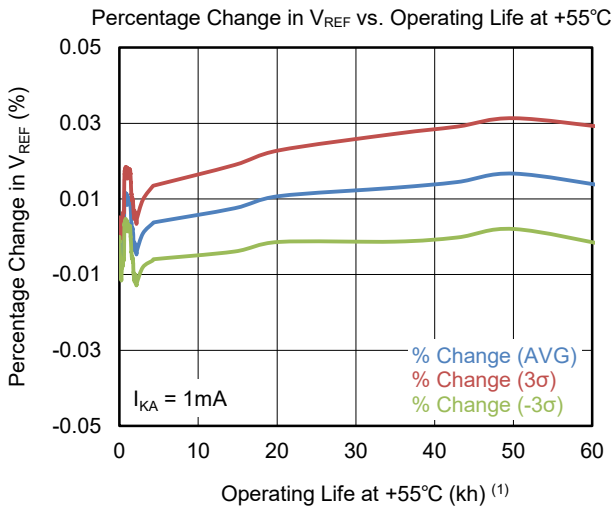

NOTE: (1) Extrapolated from test data taken at +125°C; the activation energy assumed is 0.7eV

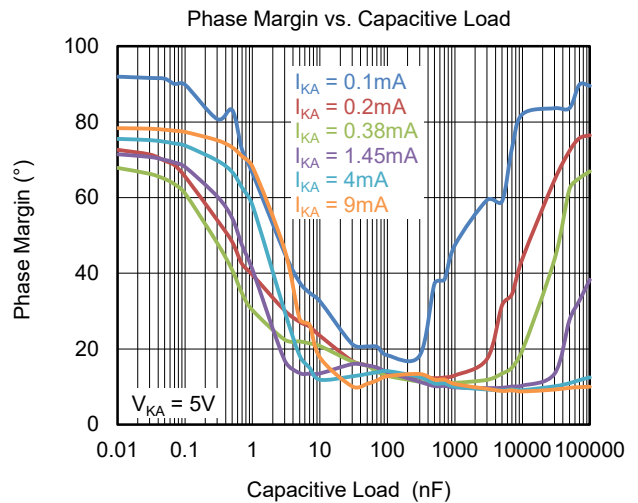
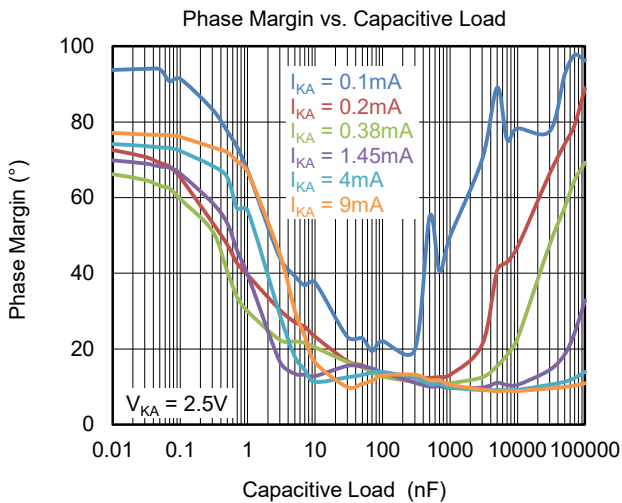

APPLICATION INFORMATION

SGM431V Used as Comparator with Integrated Reference

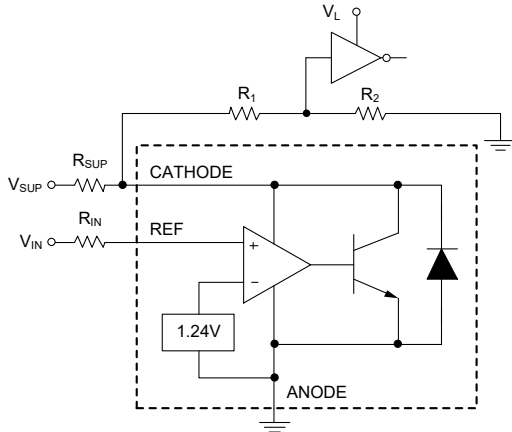

Figure 3. Comparator Application Schematic

Table 1. Design Parameters

Design Parameter	Example Value
Input Voltage Range	0V to 5V
Input Resistance	10kΩ
Supply Voltage	9V
Cathode Current (I_{KA})	500μA
Output Voltage Level	~1V to V_{SUP}
Logic Input Thresholds V_{IH}/V_{IL}	V_L

As shown in Figure 3, the SGM431V is always used as a comparator with 1.24V integrated reference in application, for this design, the parameters are listed in Table 1. The REF pin voltage is compared with reference inside and is amplified. Also, the SGM431V responds fast if the operation current I_{KA} is large

enough. The maximum cathode current of I_{MIN} is 80μA, any cathode current below this value will cause a low response (low open-loop gain) for the application of comparator.

The overdrive voltage is defined as the voltage over the internal reference voltage (1.24V). If the overdrive voltage is not large enough, the output response will be inaccurate and slow. On the contrary, the larger overdrive voltage provided at the REF pin, the faster the output response will be. Moreover, if the users desire fast response, the overdrive voltage should be larger than 10% of the internal voltage reference.

The input resistance should be less than 10kΩ in order to minimize the voltage drop between V_{IN} and V_{REF} . The readability of the logic output of the comparator should be guaranteed so that it can be received by the next stage. However, for the logic stage which is powered by 2.5V or 1.8V, the V_{IL} is hard to be figured out. To accommodate this, a voltage divider should be taken into account. Due to the Open-Collector (OC) output stage, the V_{IH} is equal to the voltage of its power supply. When the voltage divider is used to attenuate V_{IH} , please make sure that the sum of R_1 and R_2 is greater than the resistance R_{SUP} to the power supply.

However, for this application, an external resistor R_{IN} is required to provide the I_{REF} and guarantee the normal operation of the SGM431V. Also, because of the voltage drop across R_{IN} , so that the gap between V_{IN} and V_{REF} is the voltage drop of R_{IN} . To decrease the error, the selected R_{IN} should be small enough as the maximum I_{REF} is 0.15μA.

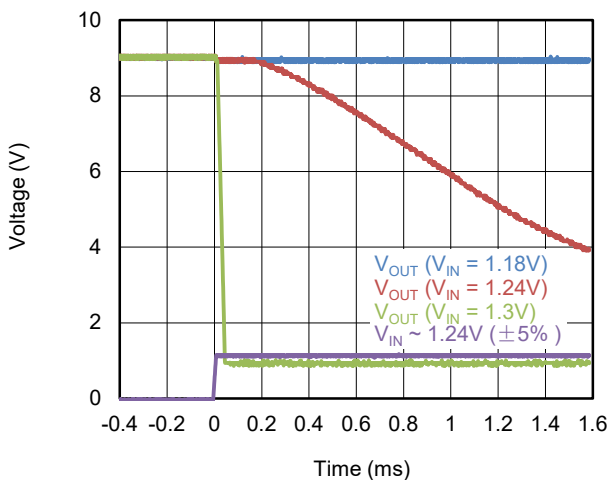

Figure 4. Output Response with Small Overdrive Voltages

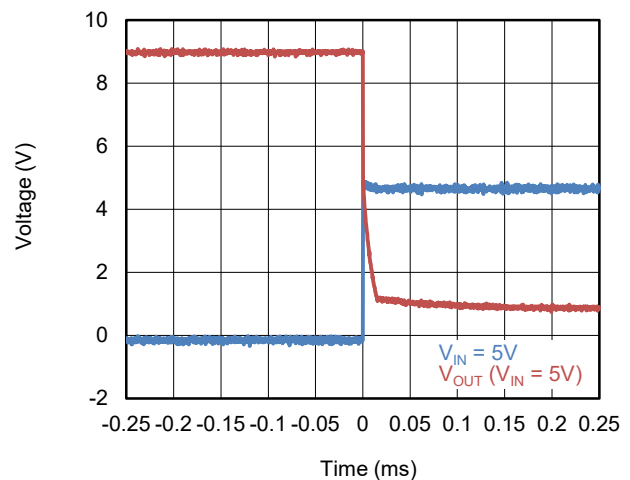

Figure 5. Output Response with Large Overdrive Voltage

APPLICATION INFORMATION (continued)

Shunt Regulator/Reference

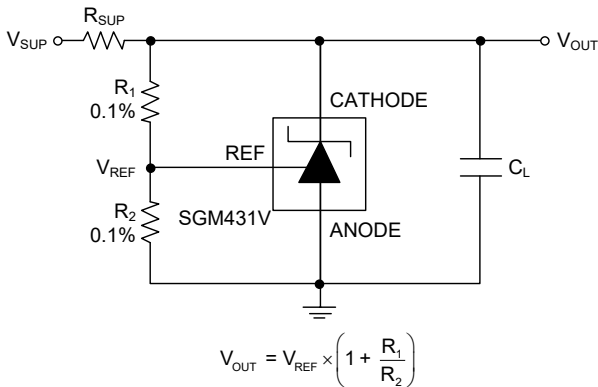

Figure 6. Shunt Regulator Schematic

Design Requirements

As shown in Figure 6 for this design, the input parameters are listed in Table 2.

Table 2. Design Parameters

Design Parameter	Example Value
Reference Initial Accuracy	1.0%
Supply Voltage	6V
Cathode Current (I _{KA})	500µA
Output Voltage Level	1.24V to 6V
Load Capacitance	4.7µF
Feedback Resistor Values and Accuracy (R ₁ and R ₂)	10kΩ

Programming Output Voltage

The output/cathode voltage of the SGM431V is programmed by resistor R₁ and R₂. The following equation shows the relationship between V_{REF} and V_{OUT}. In accurate applications, the error caused by I_{REF} should also be taken into account:

$$V_{OUT} = V_{REF} \times \left(1 + \frac{R_1}{R_2}\right) + I_{REF} \times R_1$$

And the users need to ensure that the SGM431V is fully biased, so that this error can be decreased significantly by the enough open-loop gain. This can be qualified by satisfying the minimum cathode current I_{MIN} in Electrical Characteristics.

Total Accuracy

When the output voltage is set higher than unity gain (1.24V), the behavior of the SGM431V will be influenced by the following possible errors:

- ♦ The accuracy of both R₁ and R₂.
- ♦ The internal reference voltage will be changed by the temperature.
- ♦ ΔV_{REF}/ΔV_{KA}: The change of internal reference voltage will affect the output voltage.
- ♦ |Z_{KA}|: This impedance will be affected by the cathode current.

The above possible errors are the worst cases for the operation of the SGM431V.

Stability

For traditional 431 devices, the reference output stability is affected by output decoupling capacitor which must be selected in a limited range in order to keep 431 devices stable in applications. However, the SGM431V is different from the others. The SGM431V uses a special design to greatly improve output stability when it drives capacitive load. From the curve of the Cathode Current vs. Load Capacitance in Figure 7, the output of the SGM431V is stable in a wider range of capacitive load. If the SGM431V is used as a linear regulator, a bigger decoupling capacitor can be used to improve regulator's load transient or reduce the noise of power supply. If the SGM431V is used to replace the others, the SGM431V will be stable and there is no need to change the output decoupling capacitor in the original design.

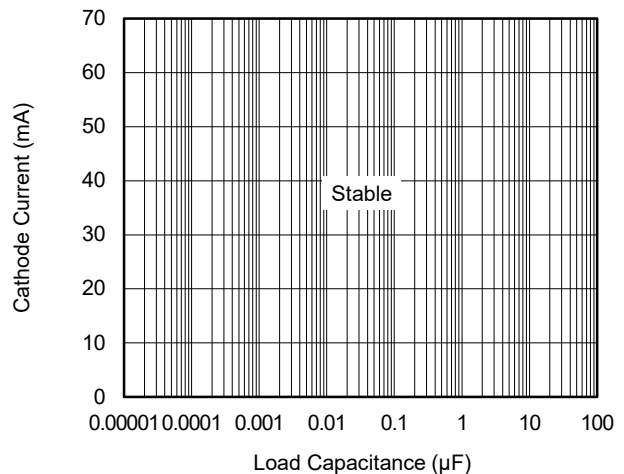

Figure 7. Cathode Current vs. Load Capacitance

APPLICATION INFORMATION (continued)

Start-Up Time

As shown in Figure 8, the SGM431V is suitable for many clamp applications with the fast response.

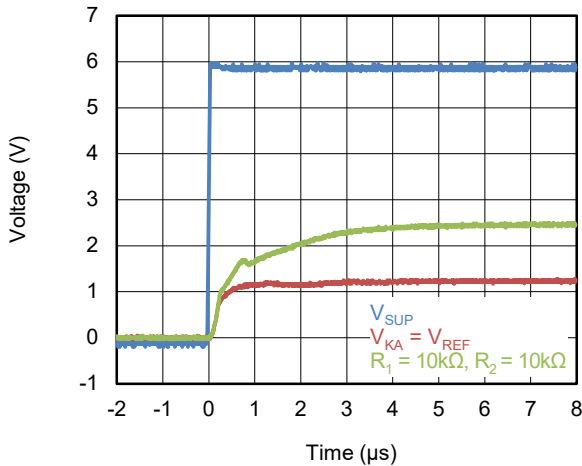

Figure 8. SGM431V Start-Up Response

Power Supply Recommendations

When the SGM431V is used as a shunt regulator, it is necessary to use a bypass capacitor on the CATHODE pin.

Limiting the current of the power supply is necessary for the SGM431V to operate within the maximum cathode current. Also, the current of the REF pin should be limited as well.

When the device shunts high current, adjusting the width and length of traces on the CATHODE pin and ANODE pin is necessary in the PCB board to have a proper density of current.

Layout

Please make sure that the bypass capacitor is close enough to the part. The width of trace on the PCB should be fit for its amount of current flowing. For the SGM431V, these currents will not be large.

REVISION HISTORY

NOTE: Page numbers for previous revisions may differ from page numbers in the current version.

SEPTEMBER 2022 – REV.A.1 to REV.A.2	Page
Added Figure 7 to Application Information section	9
JUNE 2022 – REV.A to REV.A.1	Page
Updated Application Information section.....	8, 9, 10
Changes from Original (DECEMBER 2020) to REV.A	Page
Changed from product preview to production data.....	All

PACKAGE OUTLINE DIMENSIONS

SOT-23

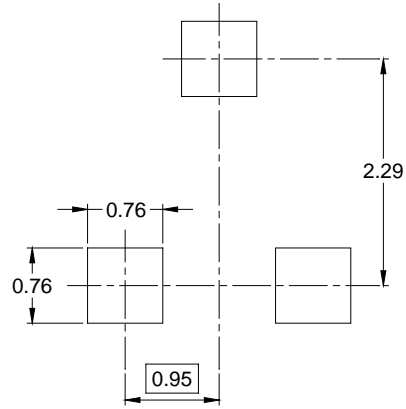
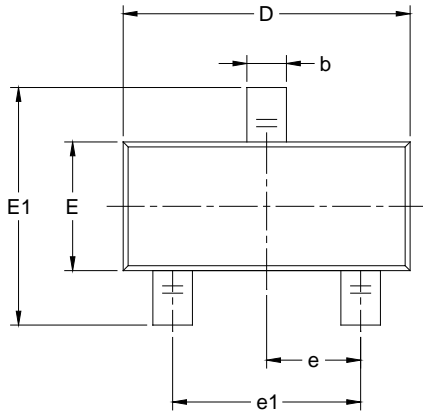

RECOMMENDED LAND PATTERN (Unit: mm)

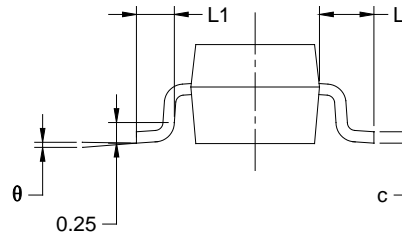
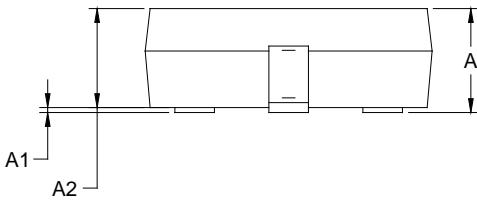

Symbol	Dimensions In Millimeters		Dimensions In Inches	
	MIN	MAX	MIN	MAX
A	0.89	1.12	0.035	0.044
A1	0.01	0.10	0.000	0.004
A2	0.88	1.02	0.035	0.040
b	0.30	0.50	0.012	0.020
c	0.08	0.20	0.003	0.008
D	2.80	3.04	0.110	0.120
E	1.20	1.40	0.047	0.055
E1	2.10	2.64	0.083	0.104
e	0.95 BSC		0.037 BSC	
e1	1.90 BSC		0.075 BSC	
L	0.54 REF		0.021 REF	
L1	0.40	0.60	0.016	0.024
θ	0°	8°	0°	8°

NOTES:

1. Body dimensions do not include mode flash or protrusion.
2. This drawing is subject to change without notice.

PACKAGE INFORMATION

TAPE AND REEL INFORMATION

REEL DIMENSIONS



TAPE DIMENSIONS



NOTE: The picture is only for reference. Please make the object as the standard.

KEY PARAMETER LIST OF TAPE AND REEL

Package Type	Reel Diameter	Reel Width W1 (mm)	A0 (mm)	B0 (mm)	K0 (mm)	P0 (mm)	P1 (mm)	P2 (mm)	W (mm)	Pin1 Quadrant
SOT-23	7"	9.5	3.15	2.77	1.22	4.0	4.0	2.0	8.0	Q3

000001

PACKAGE INFORMATION

CARTON BOX DIMENSIONS



NOTE: The picture is only for reference. Please make the object as the standard.

KEY PARAMETER LIST OF CARTON BOX

Reel Type	Length (mm)	Width (mm)	Height (mm)	Pizza/Carton
7" (Option)	368	227	224	8
7"	442	410	224	18

DD0002