

SL05T1G Series

ESD Protection Diode

Low Capacitance

This family of surge protection offers transient overvoltage protection with significantly reduced capacitance. The capacitance is lowered by integrating a compensating diode in series. This integrated solution offers ESD protection for high speed interfaces such as communication systems, computers, and computer peripherals.

Features

- Surge protection Diode in Series with a Compensating Diode Offers <5 pF Capacitance
- ESD Protection Meeting IEC 61000-4-2, 4-4, 4-5
- Peak Power Rating of 300 W, 8 × 20 μs
- Bi-Direction Protection Can Be Achieved By Using Two Devices
- Flammability Rating UL 94 V-0
- SZ Prefix for Automotive and Other Applications Requiring Unique Site and Control Change Requirements; AEC-Q101 Qualified and PPAP Capable
- These Devices are Pb-Free, Halogen Free/BFR Free and are RoHS Compliant

Mechanical Characteristics:

CASE: Void-free, transfer-molded, thermosetting plastic case

FINISH: Corrosion resistant finish, easily solderable

MAXIMUM CASE TEMPERATURE FOR SOLDERING PURPOSES:

260°C for 10 Seconds

Package designed for optimal automated board assembly

Small package size for high density applications

Available in 8 mm Tape and Reel

Use the Device Number to order the 7 inch/3,000 unit reel.

Replace the “T1” with “T3” in the Device Number to order the 13 inch/10,000 unit reel.



ON Semiconductor®

www.onsemi.com

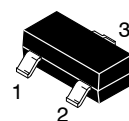
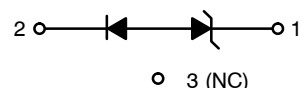

**SOT-23 (TO-236)
CASE 318
STYLE 26**

MARKING DIAGRAM

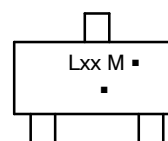

Lxx = Device Code
xx = 05, 12, 15, or 24
M = Date Code*
▪ = Pb-Free Package

(Note: Microdot may be in either location)

*Date Code orientation and/or overbar may vary depending upon manufacturing location.

ORDERING INFORMATION

Device	Package	Shipping†
SL05T1G	SOT-23 (Pb-Free)	3000/Tape & Reel
SZSL05T1G	SOT-23 (Pb-Free)	3000/Tape & Reel
SL12T1G	SOT-23 (Pb-Free)	3000/Tape & Reel
SZSL12T1G	SOT-23 (Pb-Free)	3000/Tape & Reel
SL15T1G	SOT-23 (Pb-Free)	3000/Tape & Reel
SZSL15T1G	SOT-23 (Pb-Free)	3000/Tape & Reel
SL24T1G	SOT-23 (Pb-Free)	3000/Tape & Reel
SZSL24T1G	SOT-23 (Pb-Free)	3000/Tape & Reel

†For information on tape and reel specifications, including part orientation and tape sizes, please refer to our Tape and Reel Packaging Specifications Brochure, BRD8011/D.

DEVICE MARKING INFORMATION

See specific marking information in the device marking column of the table on page 2 of this data sheet.

SL05T1G Series

MAXIMUM RATINGS

Rating	Symbol	Value	Unit
Peak Power Dissipation @ 8x20 usec (Note 1) @ $T_L \leq 25^\circ\text{C}$	P_{pk}	300	W
IEC 61000-4-2 Level 4 Contact Discharge	V_{pp}	± 8	kV
Air Discharge		± 16	kV
IEC 61000-4-4 EFT		40	A
IEC 61000-4-5 Lightning		12	A
Total Power Dissipation on FR-5 Board (Note 2) @ $T_A = 25^\circ\text{C}$ Derate above 25°C	P_D	225	mW
		1.8	mW/ $^\circ\text{C}$
Thermal Resistance Junction to Ambient	$R_{\theta JA}$	556	$^\circ\text{C}/\text{W}$
Total Power Dissipation on Alumina Substrate (Note 3) @ $T_A = 25^\circ\text{C}$ Derate above 25°C	P_D	300	mW
		2.4	mW/ $^\circ\text{C}$
Thermal Resistance Junction-to-Ambient	$R_{\theta JA}$	417	$^\circ\text{C}/\text{W}$
Junction and Storage Temperature Range	T_J, T_{stg}	- 55 to +150	$^\circ\text{C}$
Lead Solder Temperature – Maximum (10 Second Duration)	T_L	260	$^\circ\text{C}$

Stresses exceeding those listed in the Maximum Ratings table may damage the device. If any of these limits are exceeded, device functionality should not be assumed, damage may occur and reliability may be affected.

1. Non-repetitive current pulse per Figure 2
2. FR-5 = 1.0 x 0.75 x 0.62 in.
3. Alumina = 0.4 x 0.3 x 0.024 in., 99.5% alumina

ELECTRICAL CHARACTERISTICS

($T_A = 25^\circ\text{C}$ unless otherwise noted)

UNIDIRECTIONAL

Symbol	Parameter
I_{PP}	Maximum Reverse Peak Pulse Current
V_C	Clamping Voltage @ I_{PP}
V_{RWM}	Working Peak Reverse Voltage
I_R	Maximum Reverse Leakage Current @ V_{RWM}
V_{BR}	Breakdown Voltage @ I_T
I_T	Test Current
ΘV_{BR}	Maximum Temperature Coefficient of V_{BR}
I_F	Forward Current
V_F	Forward Voltage @ I_F
Z_{ZT}	Maximum Zener Impedance @ I_{ZT}
I_{ZK}	Reverse Current
Z_{ZK}	Maximum Zener Impedance @ I_{ZK}

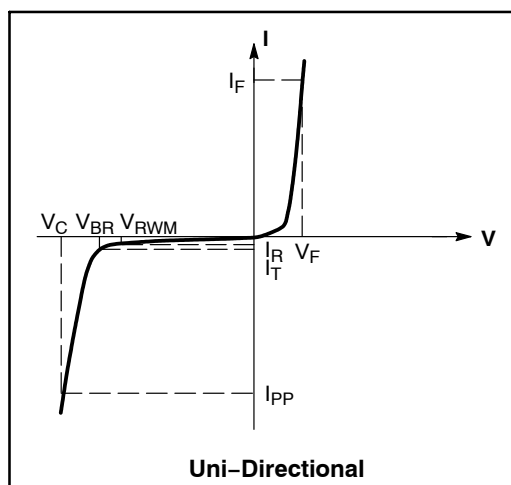

ELECTRICAL CHARACTERISTICS

Device	Device Marking	V_{RWM} (V)	I_R @ V_{RWM} (μA)	Breakdown Voltage (Note 4)		V_C , Clamping Voltage (Note 5)		Max I_{PP} (A)	Capacitance @ $V_R = 0\text{ V}, 1\text{ MHz}$ (pF)	
				V_{BR} @ 1 mA (Volts)		@ 1 A	@ 5 A		Typ	Max
				Min	Max	(V)	(V)			
SL05	L05	5.0	20	6.0	8.0	9.8	11	17	3.5	5.0
SL12	L12	12	1.0	13.3	15.5	19	24	12	3.5	5.0
SL15	L15	15	1.0	16.7	18.5	24	30	10	3.5	5.0
SL24	L24	24	1.0	26.7	29	43	55	5.0	3.5	5.0

Product parametric performance is indicated in the Electrical Characteristics for the listed test conditions, unless otherwise noted. Product performance may not be indicated by the Electrical Characteristics if operated under different conditions.

4. V_{BR} measured at pulse test current of 1 mA at an ambient temperature of 25°C
5. Surge current waveform per Figure 2

SL05T1G Series

TYPICAL CHARACTERISTICS

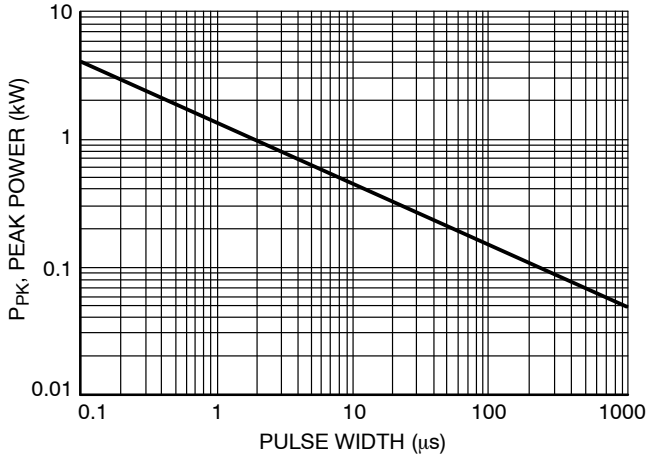

Figure 1. Maximum Peak Power Rating

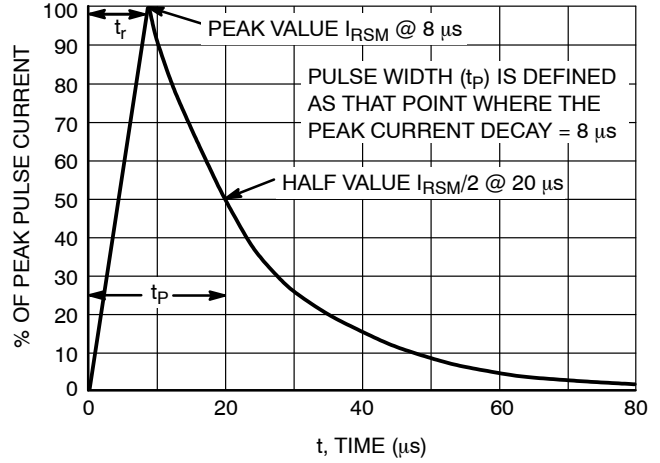

Figure 2. $8 \times 20 \mu\text{s}$ Pulse Waveform

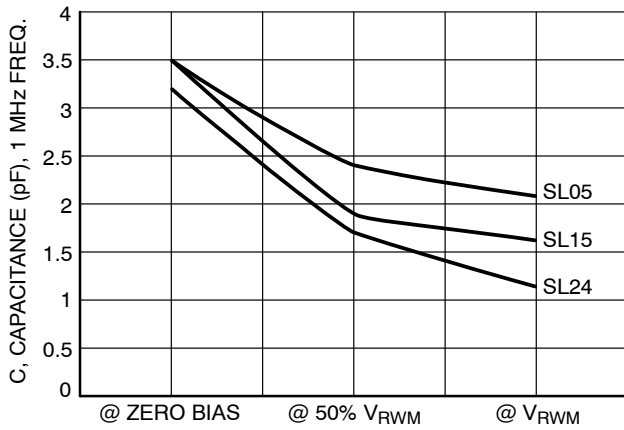

Figure 3. Typical Junction Capacitance

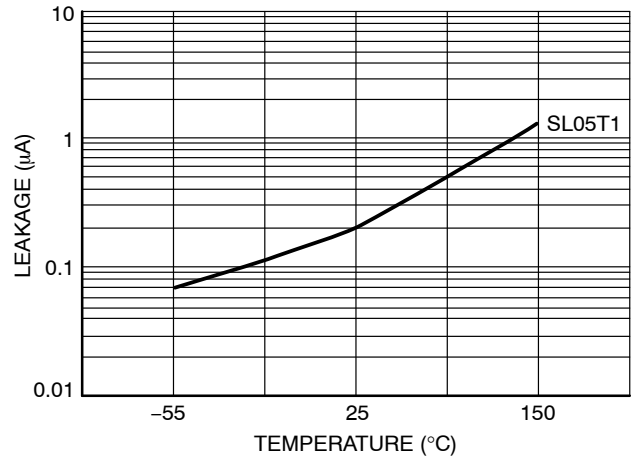

Figure 4. Typical Leakage Over Temperature

SL05T1G Series

Applications Background

This family of surge protection devices (SL05T1 series) are designed to protect sensitive electronics such as communications systems, computers, and computer peripherals against damage due to ESD conditions or transient voltage conditions. Because of their low capacitance value (less than 5 pF), they can be used in high speed I/O data lines. Low capacitance is achieved by integrating a compensating diode in series with the surge protection which is basically based in the below theoretical principle:

- Capacitance in parallel: $C_T = C_1 + C_2 + \dots + C_n$
- Capacitance in series: $1/C_T = (1/C_1) + (1/C_2) + \dots + (1/C_n)$

The Figure 5 shows the integrated solution of the SL05T1 series device:

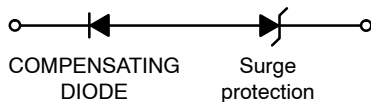

Figure 5.

In the case that an over-voltage condition occurs in the I/O line protected by the SL05T1 series device, the surge protection is reverse-biased while the compensation diode is forward-biased so the resulting current due to the transient voltage is drained to ground.

If protection in both polarities is required, an additional device is connected in inverse-parallel with reference to the first one, the Figure 6 illustrates the inverse-parallel connection for bi-directional or unidirectional lines:

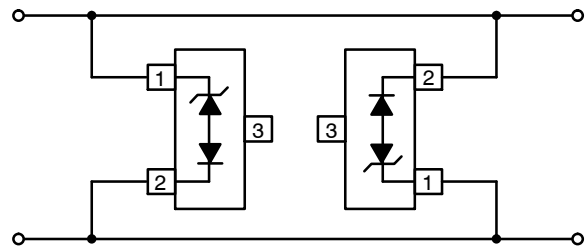

Figure 6.

An alternative solution to protect unidirectional lines, is to connect a fast switching steering diode in parallel with the SL05T1 series device. When the steering diode is forward-biased, the surge protection will avalanche and conduct in reverse direction. It is important to note that by adding a steering diode, the effective capacitance in the circuit will be increased, therefore the impact of adding a steering diode must be taken in consideration to establish whether the incremental capacitance will affect the circuit functionality or not. The Figure 7 shows the connection between the steering diode and the SL05T1 series device:

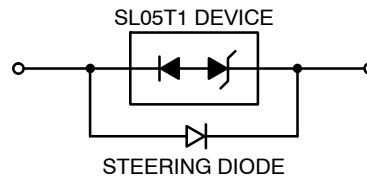

Figure 7.

Another typical application in which the SL05T1 series device can be utilized, is to protect multiple I/O lines. The protection in each of the I/O lines is achieved by connecting two devices in inverse-parallel. The Figure 8 illustrates how multiple I/O line protection is achieved:

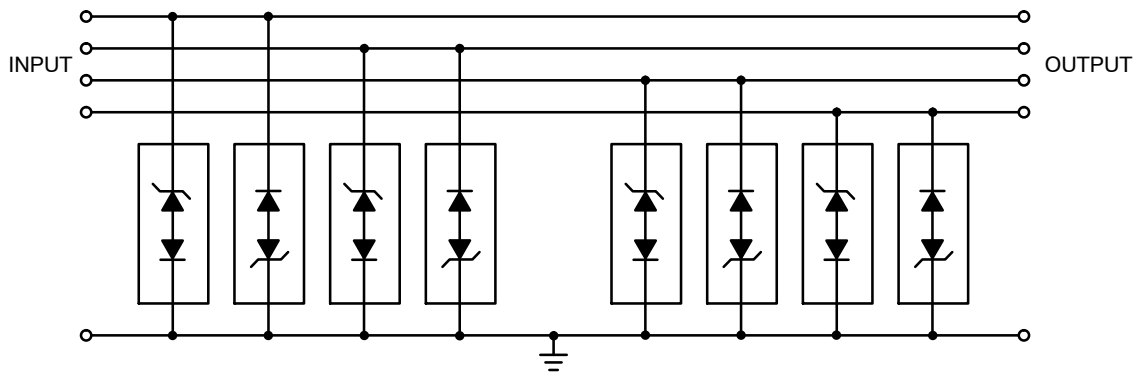

Figure 8.

For optimizing the protection, it is recommended to use ground planes and short path lengths to minimize the PCB's ground inductance.

MECHANICAL CASE OUTLINE

PACKAGE DIMENSIONS

ON Semiconductor®



SOT-23 (TO-236)
CASE 318-08
ISSUE AS

DATE 30 JAN 2018

SCALE 4:1



NOTES:

1. DIMENSIONING AND TOLERANCING PER ASME Y14.5M, 1994.
2. CONTROLLING DIMENSION: MILLIMETERS.
3. MAXIMUM LEAD THICKNESS INCLUDES LEAD FINISH. MINIMUM LEAD THICKNESS IS THE MINIMUM THICKNESS OF THE BASE MATERIAL.
4. DIMENSIONS D AND E DO NOT INCLUDE MOLD FLASH, PROTRUSIONS, OR GATE BURRS.

DIM	MILLIMETERS			INCHES		
	MIN	NOM	MAX	MIN	NOM	MAX
A	0.89	1.00	1.11	0.035	0.039	0.044
A1	0.01	0.06	0.10	0.000	0.002	0.004
b	0.37	0.44	0.50	0.015	0.017	0.020
c	0.08	0.14	0.20	0.003	0.006	0.008
D	2.80	2.90	3.04	0.110	0.114	0.120
E	1.20	1.30	1.40	0.047	0.051	0.055
e	1.78	1.90	2.04	0.070	0.075	0.080
L	0.30	0.43	0.55	0.012	0.017	0.022
L1	0.35	0.54	0.69	0.014	0.021	0.027
HE	2.10	2.40	2.64	0.083	0.094	0.104
T	0°	---	10°	0°	---	10°

RECOMMENDED SOLDERING FOOTPRINT



GENERIC MARKING DIAGRAM*



XXX = Specific Device Code
M = Date Code
▪ = Pb-Free Package

*This information is generic. Please refer to device data sheet for actual part marking. Pb-Free indicator, "G" or microdot "▪", may or may not be present.

STYLE 1 THRU 5:
CANCELLED

STYLE 6:
PIN 1. BASE
2. EMITTER
3. COLLECTOR

STYLE 7:
PIN 1. EMITTER
2. BASE
3. COLLECTOR

STYLE 8:
PIN 1. ANODE
2. NO CONNECTION
3. CATHODE

STYLE 9:
PIN 1. ANODE
2. ANODE
3. CATHODE

STYLE 10:
PIN 1. DRAIN
2. SOURCE
3. GATE

STYLE 11:
PIN 1. ANODE
2. CATHODE
3. CATHODE-ANODE

STYLE 12:
PIN 1. CATHODE
2. CATHODE
3. ANODE

STYLE 13:
PIN 1. SOURCE
2. DRAIN
3. GATE

STYLE 14:
PIN 1. CATHODE
2. GATE
3. ANODE

STYLE 15:
PIN 1. GATE
2. CATHODE
3. ANODE

STYLE 16:
PIN 1. ANODE
2. CATHODE
3. CATHODE

STYLE 17:
PIN 1. NO CONNECTION
2. ANODE
3. CATHODE

STYLE 18:
PIN 1. NO CONNECTION
2. CATHODE
3. ANODE

STYLE 19:
PIN 1. CATHODE
2. ANODE
3. CATHODE-ANODE

STYLE 20:
PIN 1. CATHODE
2. ANODE
3. GATE

STYLE 21:
PIN 1. GATE
2. SOURCE
3. DRAIN

STYLE 22:
PIN 1. RETURN
2. OUTPUT
3. INPUT

STYLE 23:
PIN 1. ANODE
2. ANODE
3. CATHODE

STYLE 24:
PIN 1. GATE
2. DRAIN
3. SOURCE

STYLE 25:
PIN 1. ANODE
2. CATHODE
3. GATE

STYLE 26:
PIN 1. CATHODE
2. ANODE
3. NO CONNECTION

STYLE 27:
PIN 1. CATHODE
2. CATHODE
3. CATHODE

STYLE 28:
PIN 1. ANODE
2. ANODE
3. ANODE

DOCUMENT NUMBER:	98ASB42226B	Electronic versions are uncontrolled except when accessed directly from the Document Repository. Printed versions are uncontrolled except when stamped "CONTROLLED COPY" in red.
DESCRIPTION:	SOT-23 (TO-236)	PAGE 1 OF 1

ON Semiconductor and ON are trademarks of Semiconductor Components Industries, LLC dba ON Semiconductor or its subsidiaries in the United States and/or other countries. ON Semiconductor reserves the right to make changes without further notice to any products herein. ON Semiconductor makes no warranty, representation or guarantee regarding the suitability of its products for any particular purpose, nor does ON Semiconductor assume any liability arising out of the application or use of any product or circuit, and specifically disclaims any and all liability, including without limitation special, consequential or incidental damages. ON Semiconductor does not convey any license under its patent rights nor the rights of others.

onsemi, **Onsemi**, and other names, marks, and brands are registered and/or common law trademarks of Semiconductor Components Industries, LLC dba "**onsemi**" or its affiliates and/or subsidiaries in the United States and/or other countries. **onsemi** owns the rights to a number of patents, trademarks, copyrights, trade secrets, and other intellectual property. A listing of **onsemi**'s product/patent coverage may be accessed at www.onsemi.com/site/pdf/Patent-Marking.pdf. **onsemi** reserves the right to make changes at any time to any products or information herein, without notice. The information herein is provided "as-is" and **onsemi** makes no warranty, representation or guarantee regarding the accuracy of the information, product features, availability, functionality, or suitability of its products for any particular purpose, nor does **onsemi** assume any liability arising out of the application or use of any product or circuit, and specifically disclaims any and all liability, including without limitation special, consequential or incidental damages. Buyer is responsible for its products and applications using **onsemi** products, including compliance with all laws, regulations and safety requirements or standards, regardless of any support or applications information provided by **onsemi**. "Typical" parameters which may be provided in **onsemi** data sheets and/or specifications can and do vary in different applications and actual performance may vary over time. All operating parameters, including "Typicals" must be validated for each customer application by customer's technical experts. **onsemi** does not convey any license under any of its intellectual property rights nor the rights of others. **onsemi** products are not designed, intended, or authorized for use as a critical component in life support systems or any FDA Class 3 medical devices or medical devices with a same or similar classification in a foreign jurisdiction or any devices intended for implantation in the human body. Should Buyer purchase or use **onsemi** products for any such unintended or unauthorized application, Buyer shall indemnify and hold **onsemi** and its officers, employees, subsidiaries, affiliates, and distributors harmless against all claims, costs, damages, and expenses, and reasonable attorney fees arising out of, directly or indirectly, any claim of personal injury or death associated with such unintended or unauthorized use, even if such claim alleges that **onsemi** was negligent regarding the design or manufacture of the part. **onsemi** is an Equal Opportunity/Affirmative Action Employer. This literature is subject to all applicable copyright laws and is not for resale in any manner.

PUBLICATION ORDERING INFORMATION

LITERATURE FULFILLMENT:

Email Requests to: orderlit@onsemi.com

onsemi Website: www.onsemi.com

TECHNICAL SUPPORT

North American Technical Support:

Voice Mail: 1 800-282-9855 Toll Free USA/Canada

Phone: 011 421 33 790 2910

Europe, Middle East and Africa Technical Support:

Phone: 00421 33 790 2910

For additional information, please contact your local Sales Representative