

# TMPIM 650 V 50 A Converter-Inverter-PFCs Module

Product Preview

## NXH50M65L4C2SG

The NXH50M65L4C2SG is a transfer-molded power module with Al<sub>2</sub>O<sub>3</sub> substrate containing a converter-inverter-PFC circuit consisting of single phase converter with four 75 A, 1600 V rectifiers, six 50 A, 600 V IGBTs with inverse diodes, 2-Channel interleaved PFC containing two 75 A, 650 V PFC IGBT with inverse diode, two 50 A, 650 V PFC diode, and an NTC thermistor.

### Features

- 2-Channel Interleaved PFC with Wide Switching Frequency  
18 kHz ~ 65 kHz
- 6 mm Clearance Distance between Pin to Heatsink
- Compact 73 mm x 40 mm x 8 mm Package
- Solderable Pins
- Thermistor
- These Devices are Pb-Free, Halogen Free/BFR Free and are RoHS Compliant

### Typical Applications

- HVAC
- Industrial Motor Drives
- Servo Drives

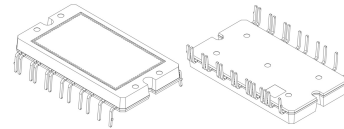

DIP27 73.2x40.2  
CASE 184AA

### MARKING DIAGRAM

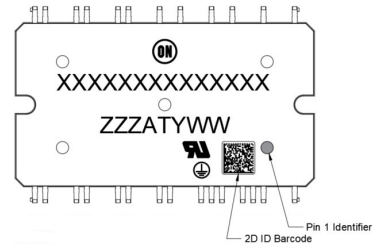

XXX = Specific Device Code  
ZZZ = Assembly Lot Code  
AT = Assembly & Test Location  
Y = Year  
WW = Work Week

### ORDERING INFORMATION

See detailed ordering and shipping information on page 18 of this data sheet.

This document contains information on a product under development. onsemi reserves the right to change or discontinue this product without notice.

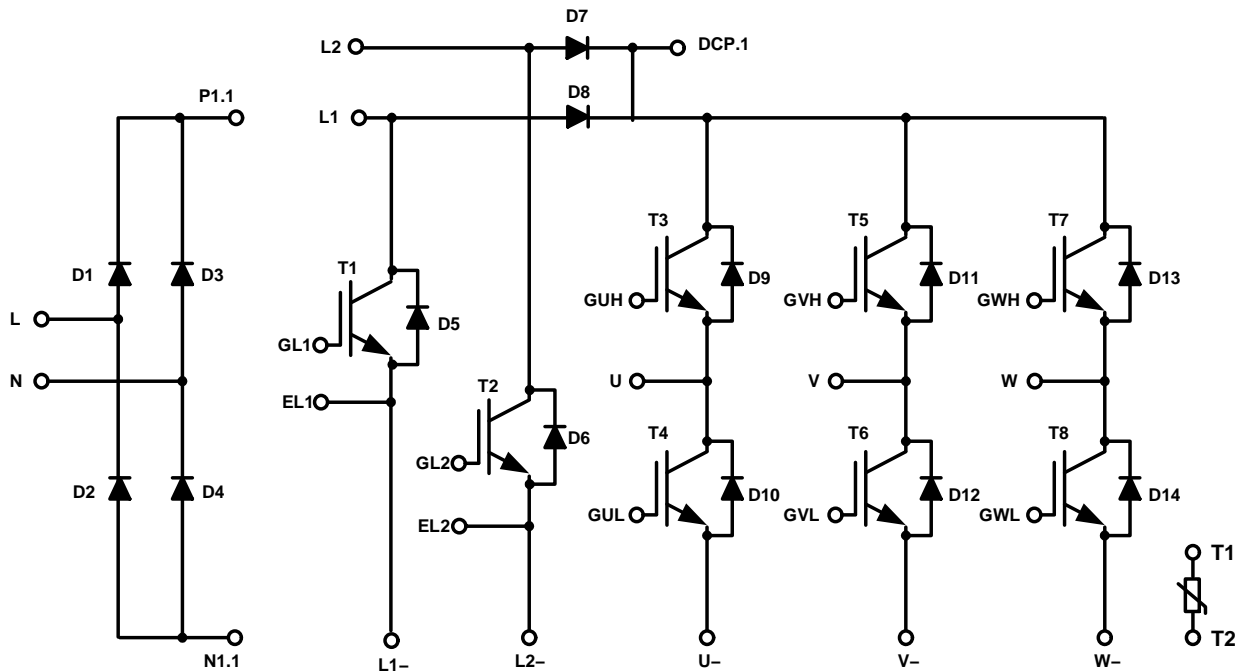
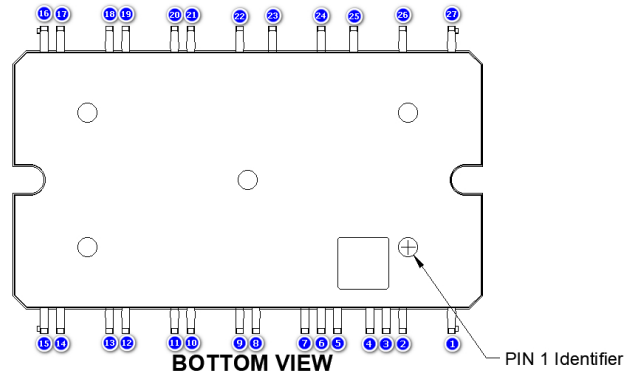

Figure 1. NXH50M65L4C2SG Schematic Diagram

# NXH50M65L4C2SG

## PIN CONFIGURATION TABLE

Pin	Name
1	N1.1
2	L1-
3	EL1
4	GL1
5	L2-
6	EL2
7	GL2
8	U-
9	GuL
10	V-
11	GvL
12	W-
13	GwL
14	T1
15	T2
16	Gwh
17	W
18	Gvh
19	V
20	Guh
21	U
22	DCP.1
23	L2
24	L1
25	P1.1
26	N
27	L



**Figure 2. Pin Configuration**

# NXH50M65L4C2SG

## MAXIMUM RATINGS

Parameter	Symbol	Value	Unit
-----------	--------	-------	------

### INVERTER IGBT (T3 – T8)

Collector–Emitter Voltage	$V_{CES}$	650	V
Gate–Emitter Voltage	$V_{GE}$	±20	V
Continuous Collector Current @ $T_c = 80^\circ\text{C}$ ( $T_{V_{Jmax}} = 175^\circ\text{C}$ )	$I_C$	50	A
Pulsed Collector Current	$I_{Cpulse}$	150	A

### INVERTER INVERSE DIODE (D9 – D14)

Peak Repetitive Reverse Voltage	$V_{RRM}$	600	V
Continuous Forward Current @ $T_c = 80^\circ\text{C}$ ( $T_{V_{Jmax}} = 175^\circ\text{C}$ )	$I_F$	30	A
Repetitive Peak Forward Current	$I_{FRM}$	90	A

### PFC IGBT (T1, T2)

Collector–Emitter Voltage	$V_{CES}$	650	V
Gate–Emitter Voltage	$V_{GE}$	±20	V
Continuous Collector Current @ $T_c = 80^\circ\text{C}$ ( $T_{V_{Jmax}} = 175^\circ\text{C}$ )	$I_C$	65	A
Pulsed Collector Current	$I_{Cpulse}$	195	A

### PFC INVERSE DIODE (D5, D6)

Peak Repetitive Reverse Voltage	$V_{RRM}$	650	V
Continuous Forward Current @ $T_c = 80^\circ\text{C}$ ( $T_{V_{Jmax}} = 175^\circ\text{C}$ )	$I_F$	15	A
Repetitive Peak Forward Current	$I_{FRM}$	45	A

### PFC DIODE (D7, D8)

Peak Repetitive Reverse Voltage	$V_{RRM}$	650	V
Continuous Forward Current @ $T_c = 80^\circ\text{C}$ ( $T_{V_{Jmax}} = 175^\circ\text{C}$ )	$I_F$	50	A
Repetitive Peak Forward Current	$I_{FRM}$	150	A

### CONVERTER DIODE (D1 – D4)

Peak Repetitive Reverse Voltage	$V_{RRM}$	1600	V
Continuous Forward Current @ $T_c = 80^\circ\text{C}$ ( $T_{V_{Jmax}} = 150^\circ\text{C}$ )	$I_F$	74	A
Repetitive Peak Forward Current	$I_{FRM}$	222	A
$I^2t$ Value (10 ms Single Half–sine Wave) @ $150^\circ\text{C}$	$I^2t$	1200	$\text{A}^2\text{s}$
Surge Current (10 ms sin $180^\circ$ ) @ $25^\circ\text{C}$	IFSM	635	A

### THERMAL PROPERTIES

Storage Temperature Range	$T_{stg}$	–40 to 125	$^\circ\text{C}$
---------------------------	-----------	------------	------------------

### INSULATION PROPERTIES

Isolation Test Voltage, $t = 1$ s, 50 Hz	$V_{is}$	3000	$V_{RMS}$
Internal Isolation		Al <sub>2</sub> O <sub>3</sub>	
Creepage Distance		6.0	mm
Clearance Distance		6.0	mm
Comperative Tracking Index	CTI	>400	

Stresses exceeding those listed in the Maximum Ratings table may damage the device. If any of these limits are exceeded, device functionality should not be assumed, damage may occur and reliability may be affected.

1. Refer to ELECTRICAL CHARACTERISTICS, RECOMMENDED OPERATING RANGES and/or APPLICATION INFORMATION for Safe Operating parameters.

# NXH50M65L4C2SG

## ELECTRICAL CHARACTERISTICS (T<sub>J</sub> = 25°C unless otherwise noted)

Parameter	Test Condition	Symbol	Min	Typ	Max	Unit	
<b>INVERTER IGBT CHARACTERISTICS (T3 – T8)</b>							
Collector–Emitter Cutoff Current	V <sub>GE</sub> = 0 V, V <sub>CE</sub> = 600 V	I <sub>CES</sub>	–	–	250	μA	
Collector–Emitter Saturation Voltage	V <sub>GE</sub> = 15 V, I <sub>C</sub> = 50 A, T <sub>J</sub> = 25°C	V <sub>CE(sat)</sub>	–	1.6	2	V	
	V <sub>GE</sub> = 15 V, I <sub>C</sub> = 50 A, T <sub>J</sub> = 150°C		–	1.8	–		
Gate–Emitter Threshold Voltage	V <sub>GE</sub> = V <sub>CE</sub> , I <sub>C</sub> = 50 mA	V <sub>GE(TH)</sub>	3.8	4.7	5.7	V	
Gate Leakage Current	V <sub>GE</sub> = 20 V, V <sub>CE</sub> = 0 V	I <sub>GES</sub>	–	–	400	nA	
Turn–on Delay Time	T <sub>J</sub> = 25°C V <sub>CE</sub> = 350 V, I <sub>C</sub> = 21 A V <sub>GE</sub> = +15 V / –8 V, R <sub>G</sub> = 25 Ω	t <sub>d(on)</sub>	–	41	–	ns	
Rise Time		t <sub>r</sub>	–	24	–		
Turn–off Delay Time		t <sub>d(off)</sub>	–	184	–		
Fall Time		t <sub>f</sub>	–	78	–		
Turn–on Switching Loss per Pulse		E <sub>on</sub>	–	270	–		μJ
Turn off Switching Loss per Pulse		E <sub>off</sub>	–	450	–		
Turn–on Delay Time	T <sub>J</sub> = 125 °C V <sub>CE</sub> = 350 V, I <sub>C</sub> = 21 A V <sub>GE</sub> = +15 V / –8 V, R <sub>G</sub> = 25 Ω	t <sub>d(on)</sub>	–	52.8	–	ns	
Rise Time		t <sub>r</sub>	–	25.2	–		
Turn–off Delay Time		t <sub>d(off)</sub>	–	232	–		
Fall Time		t <sub>f</sub>	–	140.2	–		
Turn–on Switching Loss per Pulse		E <sub>on</sub>	–	390	–		μJ
Turn off Switching Loss per Pulse		E <sub>off</sub>	–	710	–		
Input Capacitance	V <sub>CE</sub> = 20 V, V <sub>GE</sub> = 0 V, f = 1 MHz	C <sub>ies</sub>	–	2608	–	pF	
Output Capacitance		C <sub>oes</sub>	–	77	–		
Reverse Transfer Capacitance		C <sub>res</sub>	–	21	–		
Total Gate Charge	V <sub>CE</sub> = 480 V, I <sub>C</sub> = 50 A, V <sub>GE</sub> = –15 V~+15 V	Q <sub>g</sub>	–	122	–	nC	
Temperature under switching conditions		T <sub>vj op</sub>	–40		150	°C	
Thermal Resistance – Chip–to–Case		R <sub>thJC</sub>	–	0.73	–	°C/W	
Thermal Resistance – Chip–to–Heatsink	Thermal grease, Thickness ≈ 3mil, λ = 2.8 W/mK	R <sub>thJH</sub>	–	1.13	–	°C/W	

## INVERTER INVERSE DIODE CHARACTERISTICS (D9 – D14)

Diode Forward Voltage	I <sub>F</sub> = 30 A, T <sub>J</sub> = 25°C	V <sub>F</sub>	–	1.9	2.7	V
	I <sub>F</sub> = 30 A, T <sub>J</sub> = 150°C		–	1.6	–	
Reverse Recovery Time	T <sub>J</sub> = 25 °C V <sub>CE</sub> = 350 V, I <sub>C</sub> = 21 A V <sub>GE</sub> = +18 V / –8 V, R <sub>G</sub> = 25 Ω	t <sub>rr</sub>	–	34	–	ns
Reverse Recovery Charge		Q <sub>rr</sub>	–	210	–	nC
Peak Reverse Recovery Current		I <sub>RPM</sub>	–	11	–	A
Reverse Recovery Energy		E <sub>rr</sub>	–	37	–	μJ
Reverse Recovery Time	T <sub>J</sub> = 125 °C V <sub>CE</sub> = 350 V, I <sub>C</sub> = 21 A V <sub>GE</sub> = +15 V / –8 V, R <sub>G</sub> = 25 Ω	t <sub>rr</sub>	–	46	–	ns
Reverse Recovery Charge		Q <sub>rr</sub>	–	472	–	nC
Peak Reverse Recovery Current		I <sub>RPM</sub>	–	16	–	A
Reverse Recovery Energy		E <sub>rr</sub>	–	82	–	μJ
Temperature under Switching Conditions		T <sub>vj op</sub>	–40		150	°C
Thermal Resistance – Chip–to–Case		R <sub>thJC</sub>	–	1.03	–	°C/W
Thermal Resistance – Chip–to–Heatsink	Thermal grease, Thickness ≈ 3 mil, λ = 2.8 W/mK	R <sub>thJH</sub>	–	1.42	–	°C/W

# NXH50M65L4C2SG

## ELECTRICAL CHARACTERISTICS (T<sub>J</sub> = 25°C unless otherwise noted) (continued)

Parameter	Test Condition	Symbol	Min	Typ	Max	Unit	
<b>PFC IGBT CHARACTERISTICS (T1, T2)</b>							
Collector–Emitter Cutoff Current	V <sub>GE</sub> = 0 V, V <sub>CE</sub> = 650 V	I <sub>CES</sub>	–	–	250	μA	
Collector–Emitter Saturation Voltage	V <sub>GE</sub> = 15 V, I <sub>C</sub> = 75 A, T <sub>J</sub> = 25°C	V <sub>CE(sat)</sub>	–	1.4	2.2	V	
	V <sub>GE</sub> = 15 V, I <sub>C</sub> = 75 A, T <sub>J</sub> = 150°C		–	1.6	–		
Gate–Emitter Threshold Voltage	V <sub>GE</sub> = V <sub>CE</sub> , I <sub>C</sub> = 75 mA	V <sub>GE(TH)</sub>	3.8	4.5	5.7	V	
Gate Leakage Current	V <sub>GE</sub> = 20 V, V <sub>CE</sub> = 0 V	I <sub>GES</sub>	–	–	400	nA	
Turn–on Delay Time	T <sub>J</sub> = 25°C V <sub>CE</sub> = 400 V, I <sub>C</sub> = 24 A V <sub>GE</sub> = +15 V / –8 V, R <sub>G</sub> = 10 Ω	t <sub>d(on)</sub>	–	47	–	ns	
Rise Time		t <sub>r</sub>	–	12	–		
Turn–off Delay Time		t <sub>d(off)</sub>	–	190	–		
Fall Time		t <sub>f</sub>	–	8	–		
Turn–on Switching Loss per Pulse		E <sub>on</sub>	–	240	–		μJ
Turn off Switching Loss per Pulse		E <sub>off</sub>	–	250	–		
Turn–on Delay Time	T <sub>J</sub> = 125 °C V <sub>CE</sub> = 400 V, I <sub>C</sub> = 24 A V <sub>GE</sub> = +15 V / –8 V, R <sub>G</sub> = 10 Ω	t <sub>d(on)</sub>	–	45	–	ns	
Rise Time		t <sub>r</sub>	–	14	–		
Turn–off Delay Time		t <sub>d(off)</sub>	–	218	–		
Fall Time		t <sub>f</sub>	–	25	–		
Turn–on Switching Loss per Pulse		E <sub>on</sub>	–	390	–		μJ
Turn off Switching Loss per Pulse		E <sub>off</sub>	–	350	–		
Input Capacitance	V <sub>CE</sub> = 20 V, V <sub>GE</sub> = 0 V, f = 10 kHz	C <sub>ies</sub>	–	4877	–	pF	
Output Capacitance		C <sub>oes</sub>	–	77	–		
Reverse Transfer Capacitance		C <sub>res</sub>	–	21	–		
Total Gate Charge	V <sub>CE</sub> = 480 V, I <sub>C</sub> = 75 A, V <sub>GE</sub> = 0 V~+15 V	Q <sub>g</sub>	–	151	–	nC	
Temperature under Switching Conditions		T <sub>vj op</sub>	–40		150	°C	
Thermal Resistance – Chip–to–Case		R <sub>thJC</sub>	–	0.63	–	°C/W	
Thermal Resistance – Chip–to–Heatsink	Thermal grease, Thickness ≈ 3 mil, λ = 2.8 W/mK	R <sub>thJH</sub>	–	1.02	–	°C/W	

## PFC IGBT INVERSE DIODE CHARACTERISTICS (D5, D6)

Rectifier Forward Voltage	I <sub>F</sub> = 15 A, T <sub>J</sub> = 25°C	V <sub>F</sub>	–	1.9	2.4	V
	I <sub>F</sub> = 15 A, T <sub>J</sub> = 150°C		–	1.8	–	
Temperature under Switching Conditions		T <sub>vj op</sub>	–40		150	°C
Thermal Resistance – Chip–to–Case		R <sub>thJC</sub>	–	2.35	–	°C/W
Thermal Resistance – Chip–to–Heatsink	Thermal grease, Thickness ≈ 3 mil, λ = 2.8 W/mK	R <sub>thJH</sub>	–	2.83	–	°C/W

## PFC DIODE CHARACTERISTICS (D7, D8)

Rectifier Reverse Leakage Current	V <sub>R</sub> = 650 V	I <sub>R</sub>	–	–	200	μA
Rectifier Forward Voltage	I <sub>F</sub> = 50 A, T <sub>J</sub> = 25°C	V <sub>F</sub>	–	2.1	2.8	V
	I <sub>F</sub> = 50 A, T <sub>J</sub> = 150°C		–	1.7	–	
Reverse Recovery Time	T <sub>J</sub> = 25 °C V <sub>CE</sub> = 400 V, I <sub>C</sub> = 24 A V <sub>GE</sub> = +15 V / –8 V, R <sub>G</sub> = 10 Ω	t <sub>rr</sub>	–	24	–	ns
Reverse Recovery Charge		Q <sub>rr</sub>	–	456	–	nC
Peak Reverse Recovery Current		I <sub>RRM</sub>	–	32	–	A
Reverse Recovery Energy		E <sub>rr</sub>	–	109	–	μJ

# NXH50M65L4C2SG

## ELECTRICAL CHARACTERISTICS (T<sub>J</sub> = 25°C unless otherwise noted) (continued)

Parameter	Test Condition	Symbol	Min	Typ	Max	Unit
<b>PFC DIODE CHARACTERISTICS (D7, D8)</b>						
Reverse Recovery Time	T <sub>J</sub> = 125 °C V <sub>CE</sub> = 400 V, I <sub>C</sub> = 24 A V <sub>GE</sub> = +15 V / -8 V, R <sub>G</sub> = 10 Ω	t <sub>rr</sub>		36		ns
Reverse Recovery Charge		Q <sub>rr</sub>	–	902	–	nC
Peak Reverse Recovery Current		I <sub>RPM</sub>	–	42	–	A
Reverse Recovery Energy		E <sub>rr</sub>	–	209	–	μJ
Temperature under Switching Conditions		T <sub>vj op</sub>	–40		150	°C
Thermal Resistance – Chip-to-Case		R <sub>thJC</sub>	–	0.75	–	°C/W
Thermal Resistance – Chip-to-Heatsink	Thermal grease, Thickness ≈ 3 mil, λ = 2.8 W/mK	R <sub>thJH</sub>	–	1.12	–	°C/W

## CONVERTER DIODE CHARACTERISTICS (D1–D4)

Rectifier Reverse Leakage Current	V <sub>R</sub> = 1600 V	I <sub>R</sub>	–	–	200	μA
Rectifier Forward Voltage	I <sub>F</sub> = 75 A, T <sub>J</sub> = 25°C	V <sub>F</sub>	–	1.3	1.7	V
	I <sub>F</sub> = 75 A, T <sub>J</sub> = 150°C		–	1.4	–	
Temperature under Switching Conditions		T <sub>vj op</sub>	–40		150	°C
Thermal Resistance – Chip-to-Case		R <sub>thJC</sub>	–	0.54	–	°C/W
Thermal Resistance – Chip-to-Heatsink	Thermal grease, Thickness ≈ 3 mil, λ = 2.8 W/mK	R <sub>thJH</sub>	–	0.87	–	°C/W

## THERMISTOR CHARACTERISTICS

Nominal Resistance	T = 25°C	R <sub>25</sub>	–	5	–	kΩ
Nominal Resistance	T = 100°C	R <sub>100</sub>	–	493.3	–	Ω
Deviation of R25		ΔR/R	–5	–	5	%
Power Dissipation		P <sub>D</sub>	–	20	–	mW
Power Dissipation Constant			–	1.4	–	mW/K
B-value	B (25/50), tolerance ±2%		–	3375	–	K
B-value	B (25/100), tolerance ±2%		–	3455	–	K

Product parametric performance is indicated in the Electrical Characteristics for the listed test conditions, unless otherwise noted. Product performance may not be indicated by the Electrical Characteristics if operated under different conditions.

# NXH50M65L4C2SG

## TYPICAL CHARACTERISTICS – T3 – T8 INVERTER IGBT & D9–D14 INVERSE DIODE

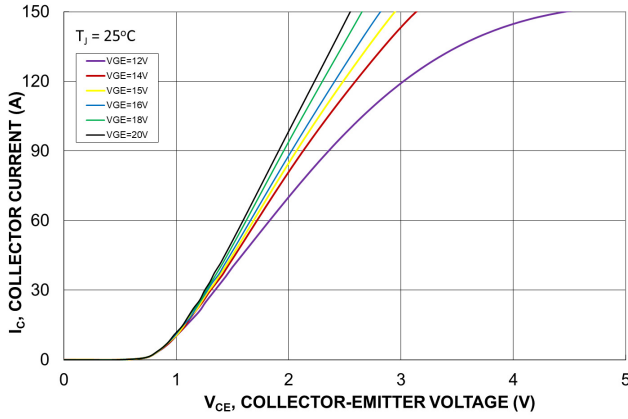

Figure 3. IGBT Typical Output Characteristics

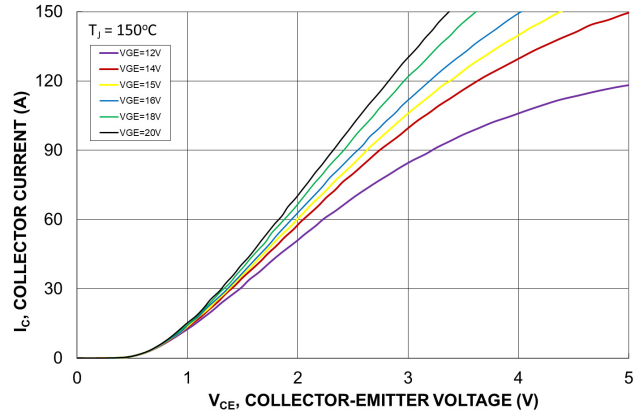

Figure 4. IGBT Typical Output Characteristics

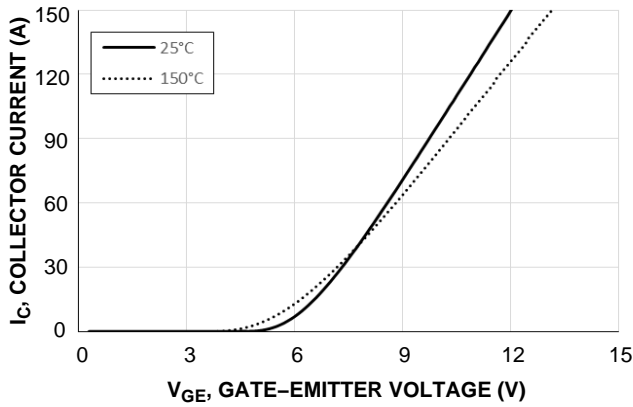

Figure 5. Typical Transfer Characteristics

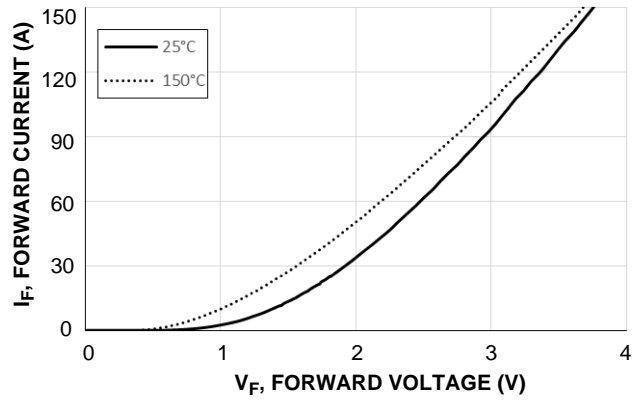

Figure 6. Diode Typical Forward Characteristics

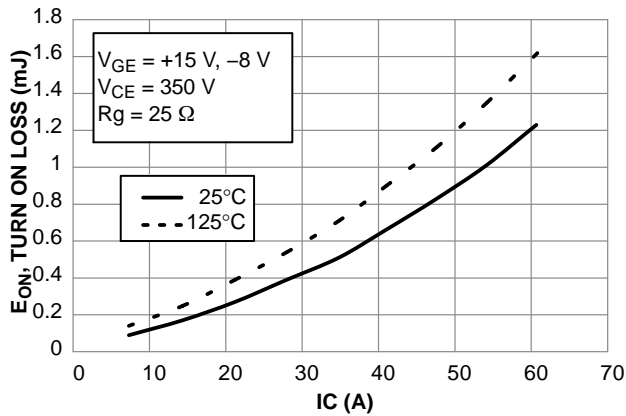

Figure 7. Typical Turn ON Loss vs. IC

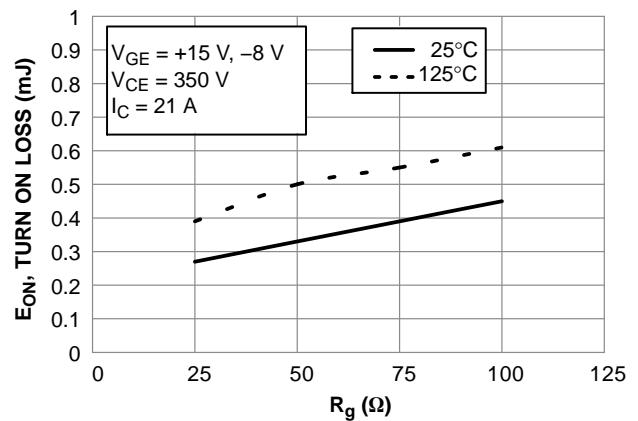

Figure 8. Typical Turn ON Loss vs. Rg

# NXH50M65L4C2SG

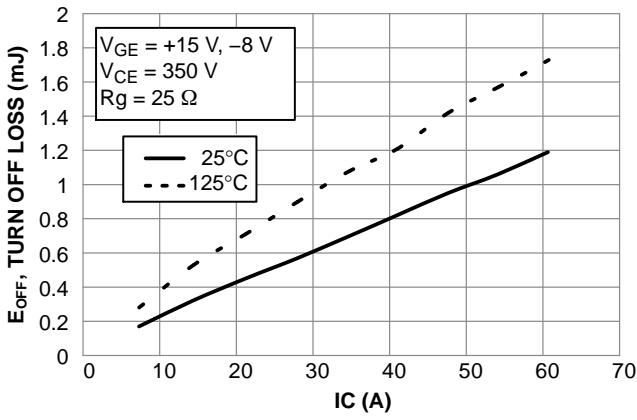

Figure 9. Typical Turn OFF Loss vs. IC

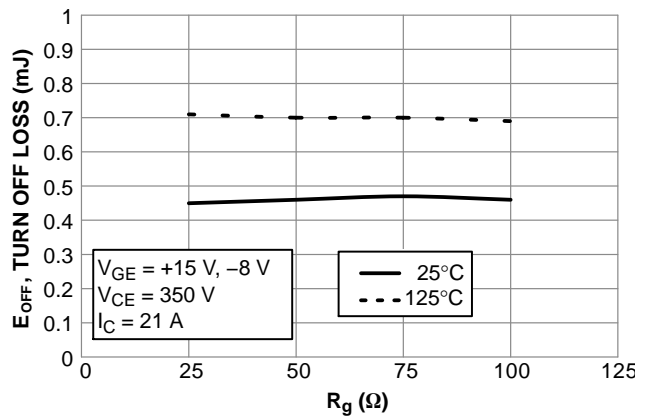

Figure 10. Typical Turn OFF Loss vs. Rg

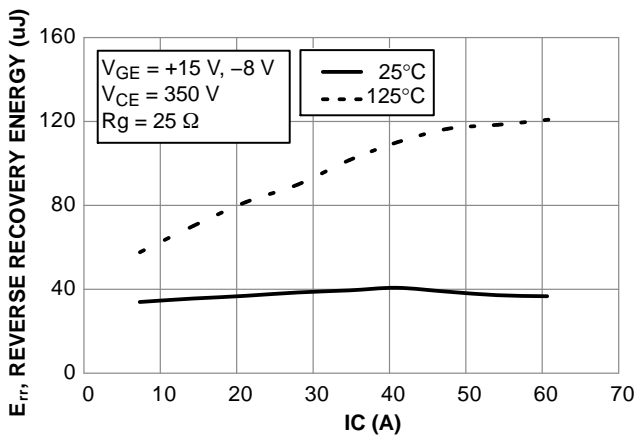

Figure 11. Typical Reverse Recovery Energy Loss vs. IC

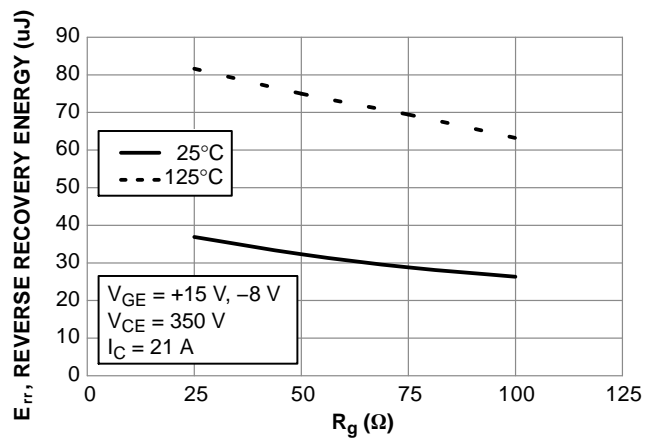

Figure 12. Typical Reverse Recovery Energy Loss vs. Rg

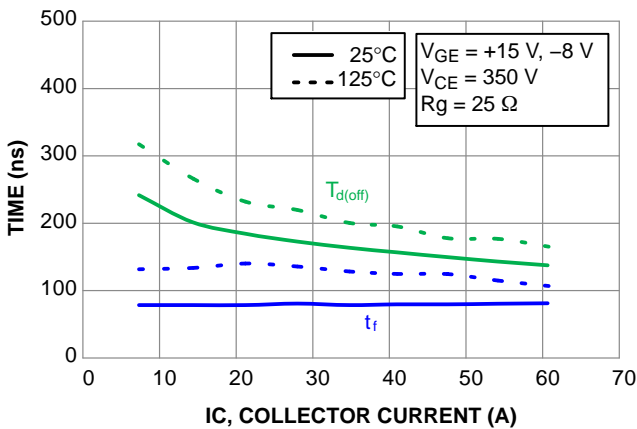

Figure 13. Typical Turn-Off Switching Time vs. IC

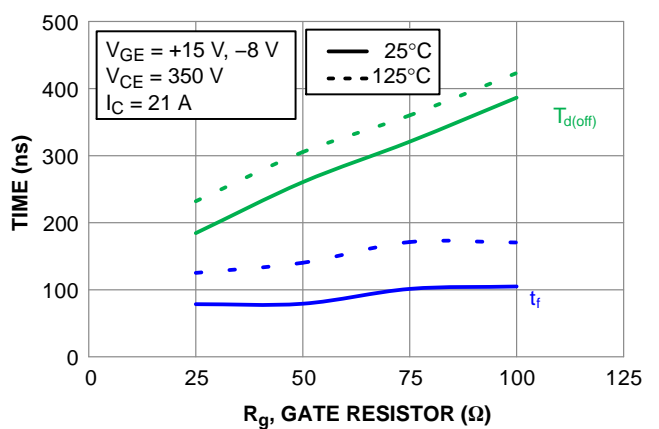

Figure 14. Typical Turn-Off Switching Time vs. Rg



# NXH50M65L4C2SG

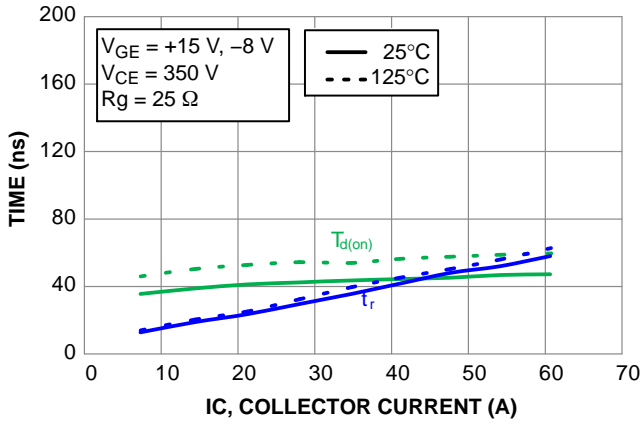

Figure 15. Typical Turn-On Switching Time vs. IC

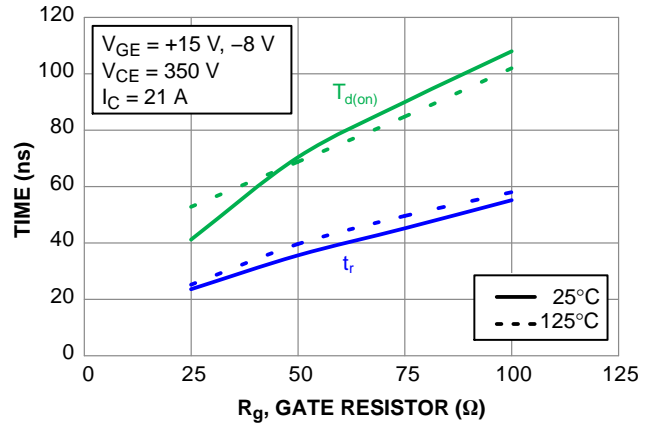

Figure 16. Typical Turn-Off Switching Time vs. Rg

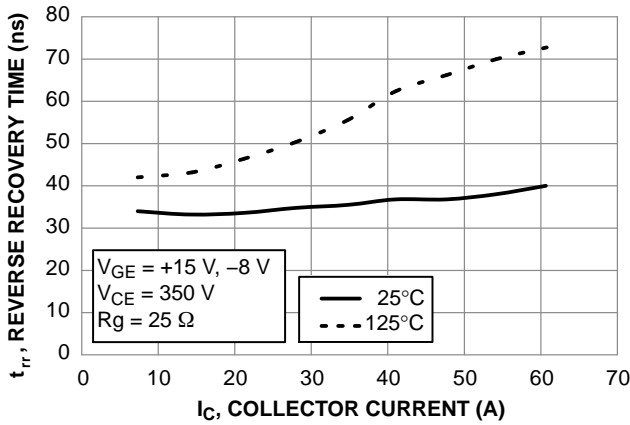

Figure 17. Typical Reverse Recovery Time vs. IC

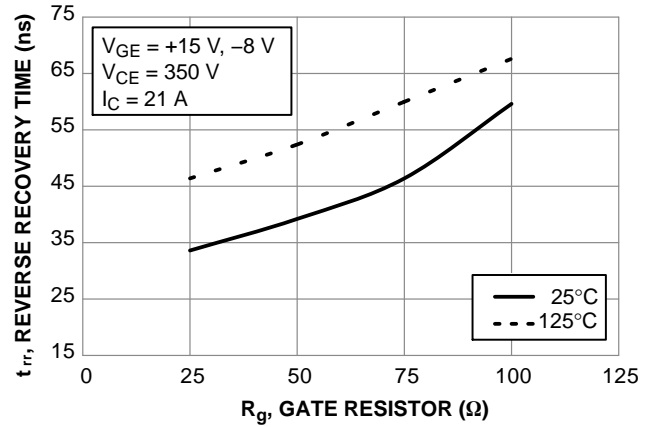

Figure 18. Typical Reverse Recovery Time vs. Rg

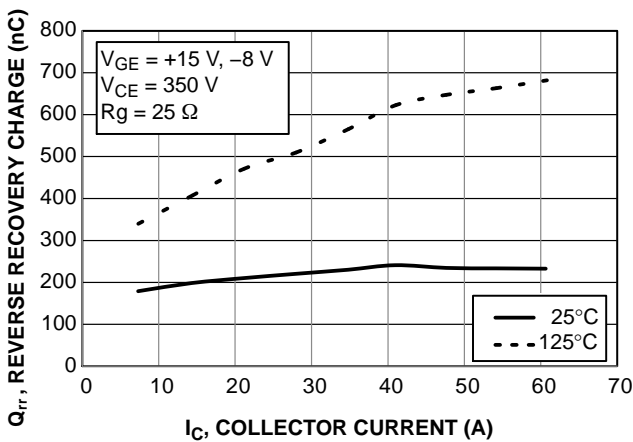

Figure 19. Typical Reverse Recovery Charge vs. IC

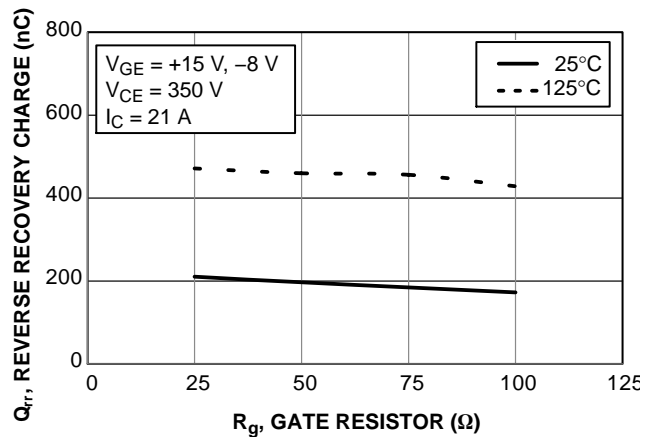

Figure 20. Typical Reverse Recovery Charge vs. Rg

# NXH50M65L4C2SG

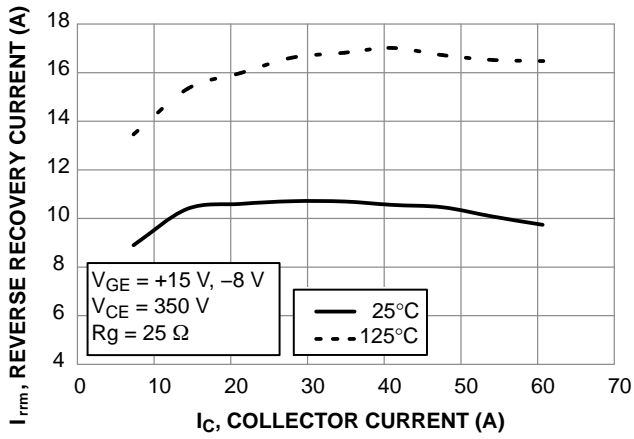

Figure 21. Typical Reverse Recovery Peak Current vs.  $I_C$

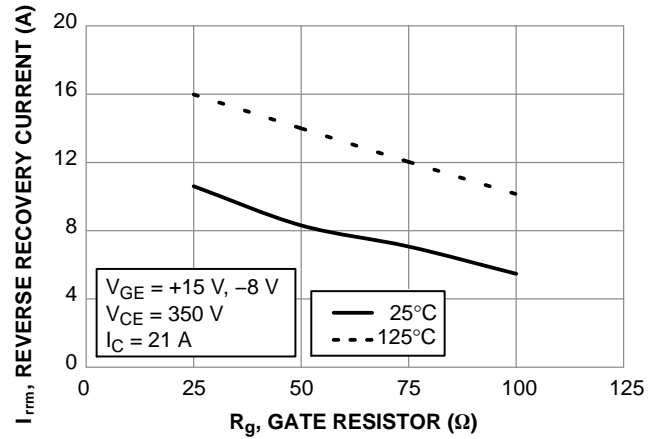

Figure 22. Typical Reverse Recovery Peak Current vs.  $R_g$

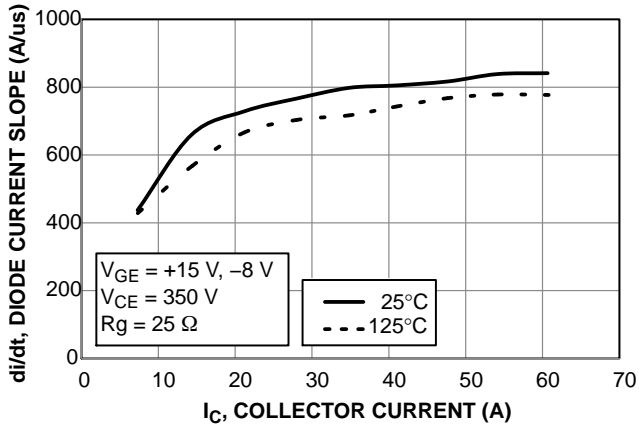

Figure 23. Typical  $di/dt$  Current Slope vs.  $I_C$

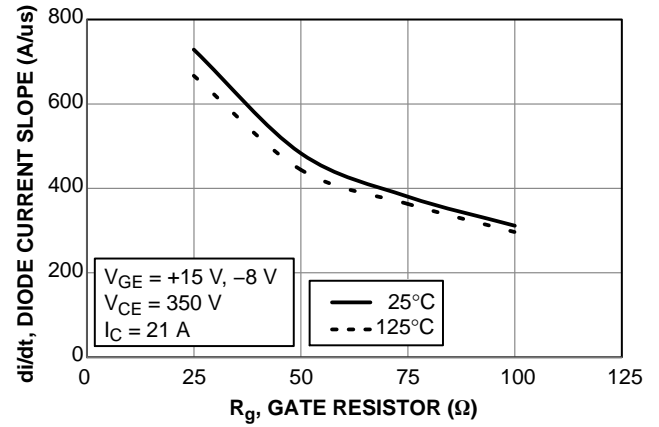

Figure 24. Typical  $di/dt$  Current Slope vs.  $R_g$

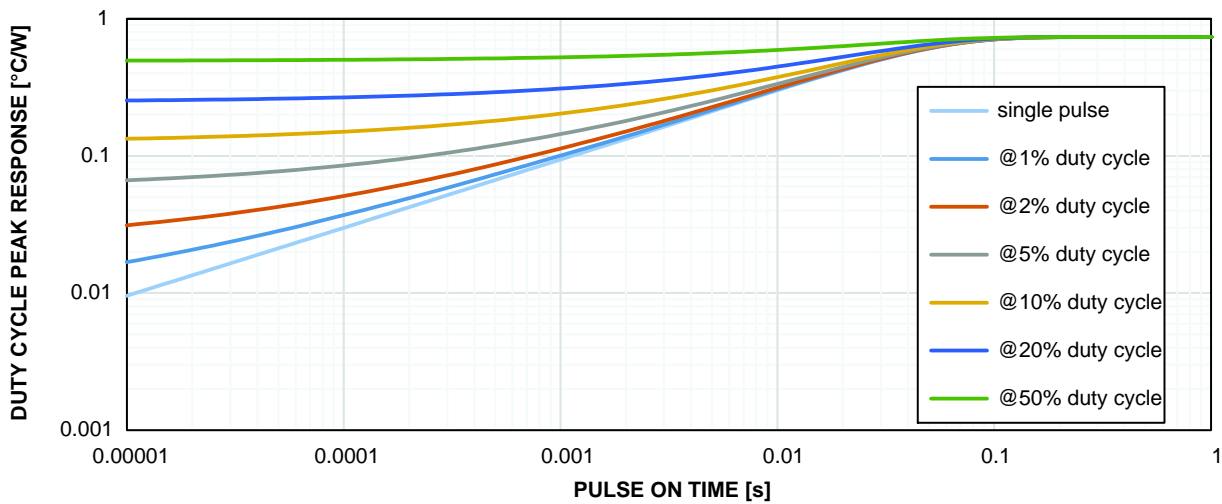
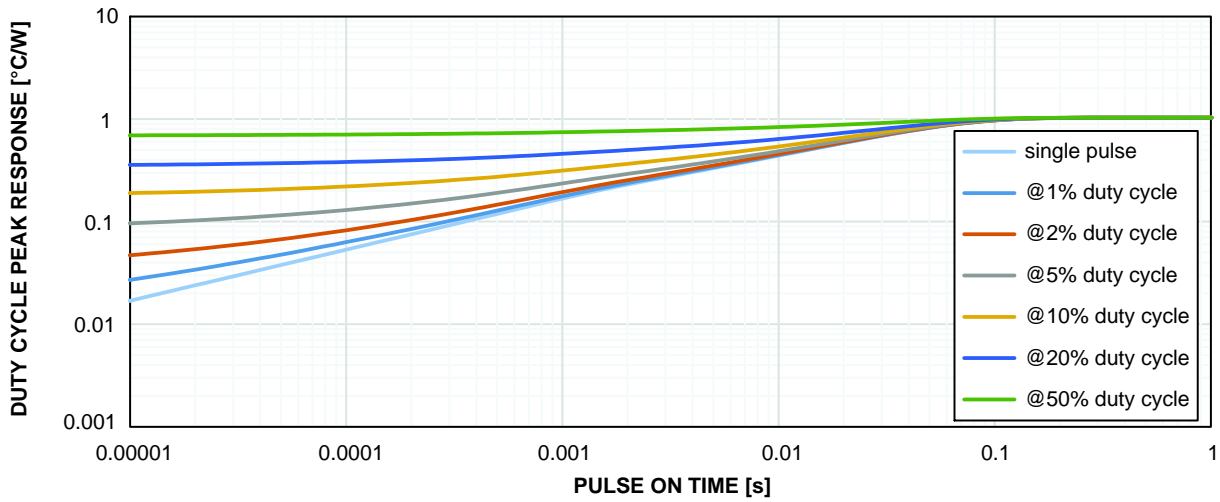
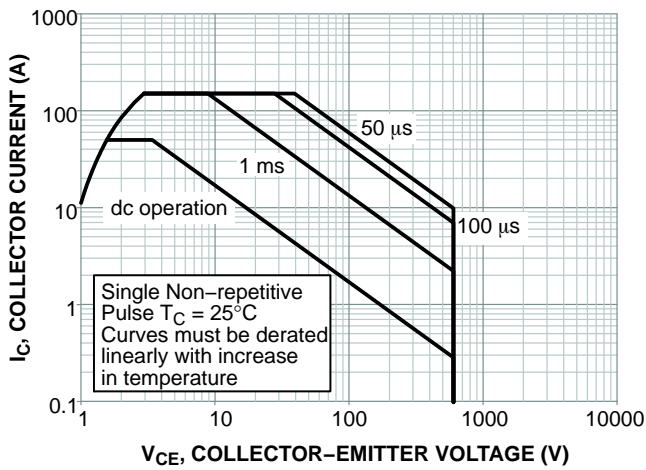

Figure 25. IGBT Junction-to-Case Transient Thermal Impedance

# NXH50M65L4C2SG



**Figure 26. Diode Junction-to-Case Transient Thermal Impedance**



**Figure 27. IGBT FBSOA**

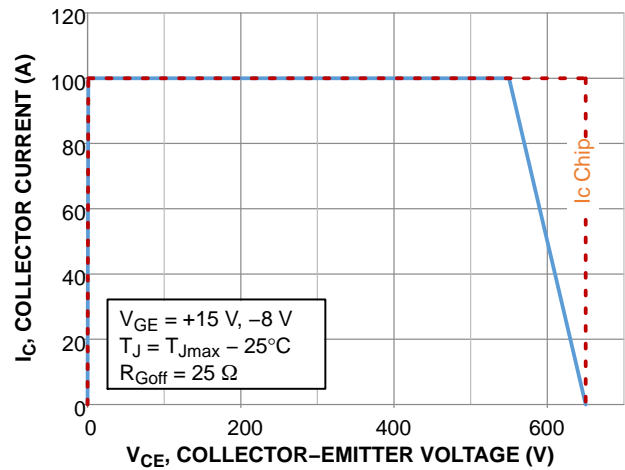

**Figure 28. IGBT RBSOA**

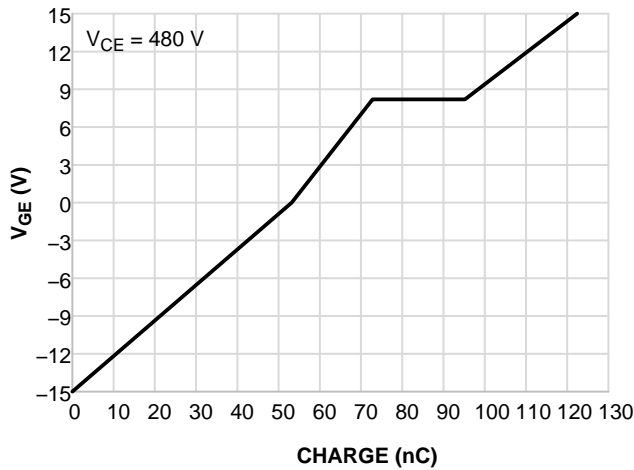

**Figure 29. IGBT Gate Voltage vs. Gate Charge**

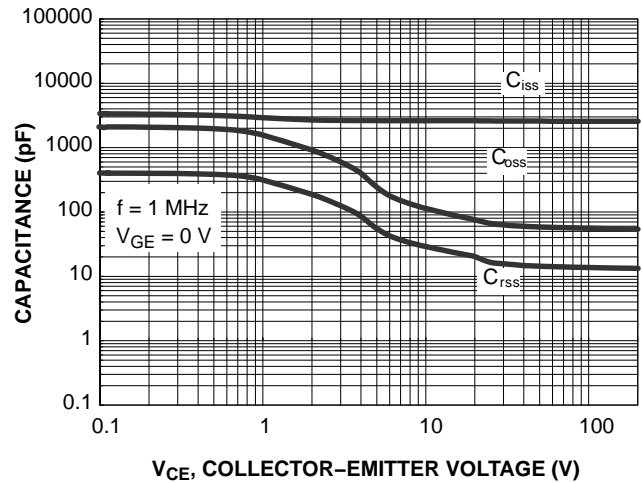

**Figure 30. IGBT Capacitance vs. Collector-Emitter Voltage**

# NXH50M65L4C2SG

## TYPICAL CHARACTERISTICS – T1 – T2 PFC IGBT & D5 – D6 INVERSE DIODE

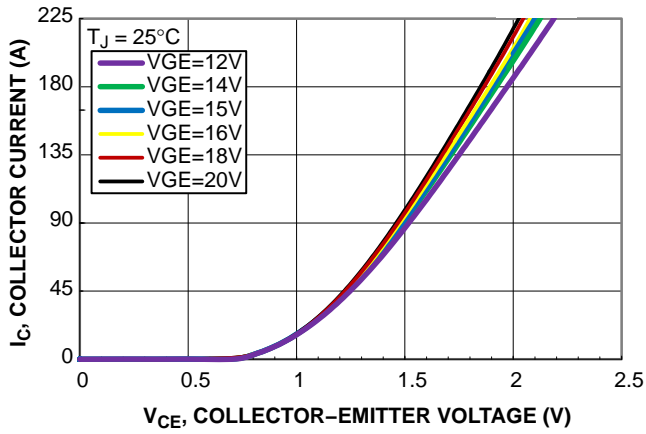

Figure 31. IGBT Typical Output Characteristic

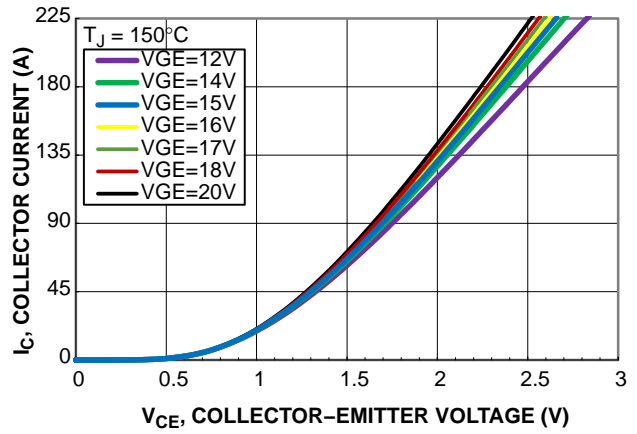

Figure 32. IGBT Typical Output Characteristic

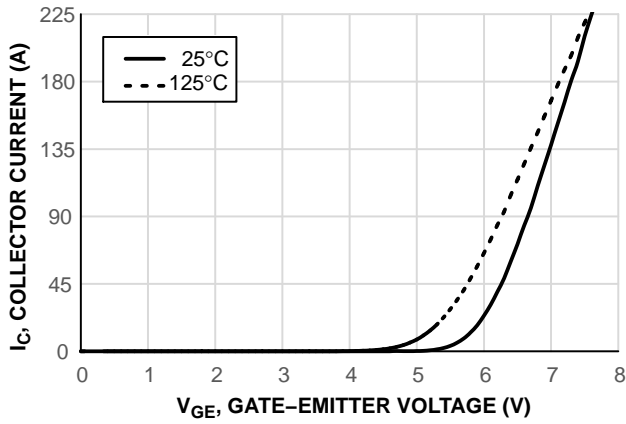

Figure 33. IGBT Typical Transfer Characteristic

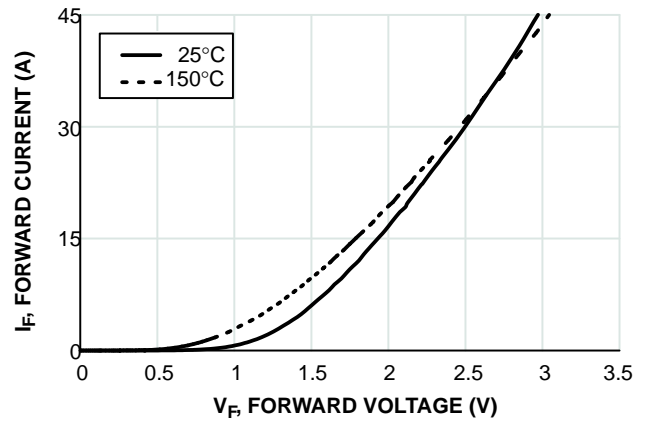

Figure 34. Diode Typical Forward Characteristic

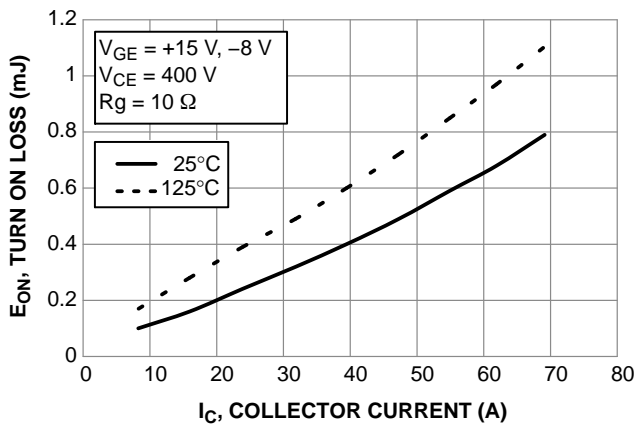

Figure 35. Typical Turn ON Loss vs. Ic

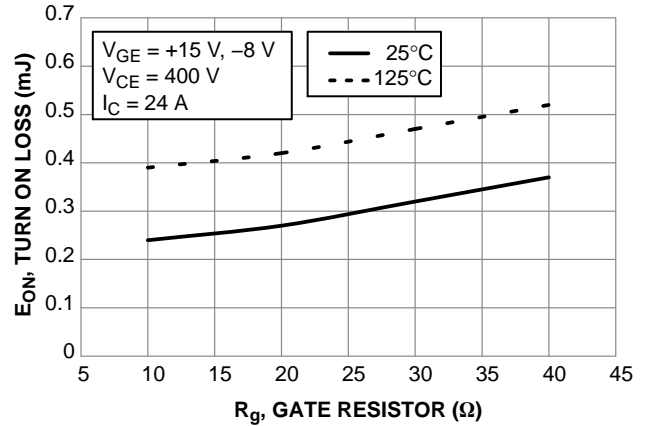

Figure 36. Typical Turn ON Loss vs. Rg

# NXH50M65L4C2SG

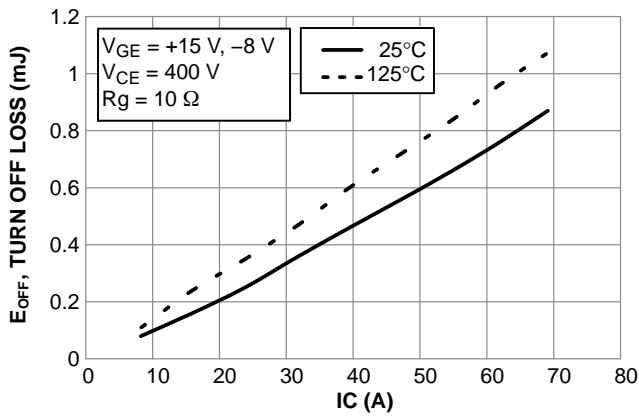

Figure 37. Typical Turn OFF Loss vs. IC

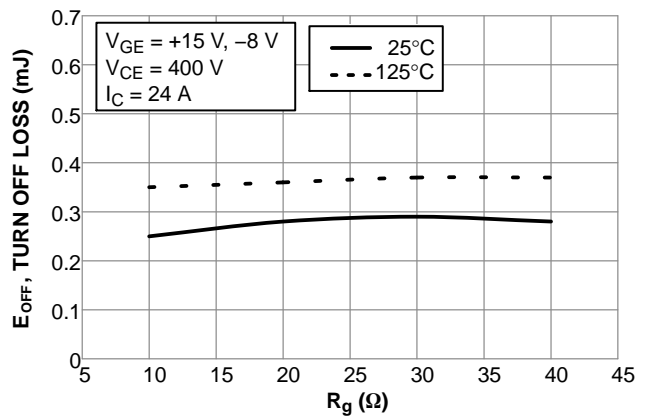

Figure 38. Typical Turn OFF Loss vs. Rg

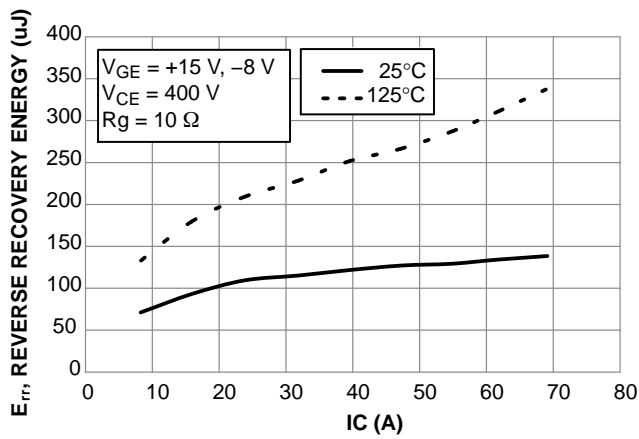

Figure 39. Typical Reverse Recovery Energy Loss vs. IC

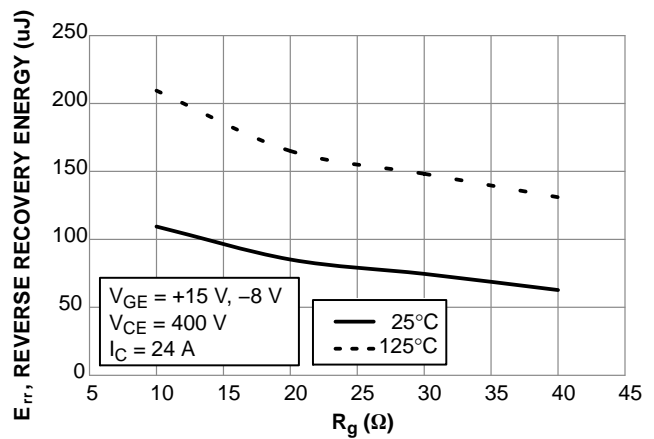

Figure 40. Typical Reverse Recovery Energy Loss vs. Rg

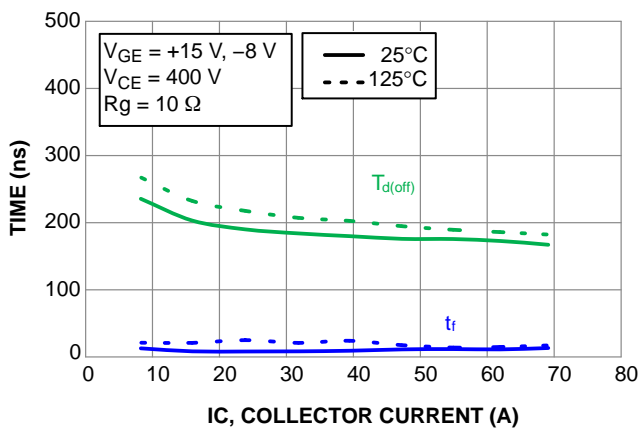

Figure 41. Typical Turn-Off Switching Time vs. IC

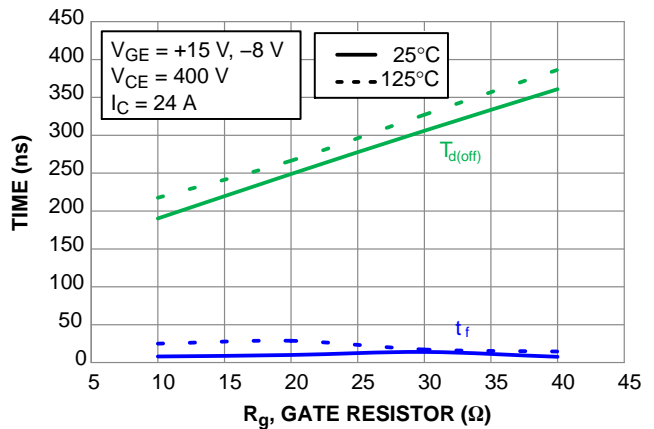

Figure 42. Typical Turn-Off Switching Time vs. Rg

# NXH50M65L4C2SG

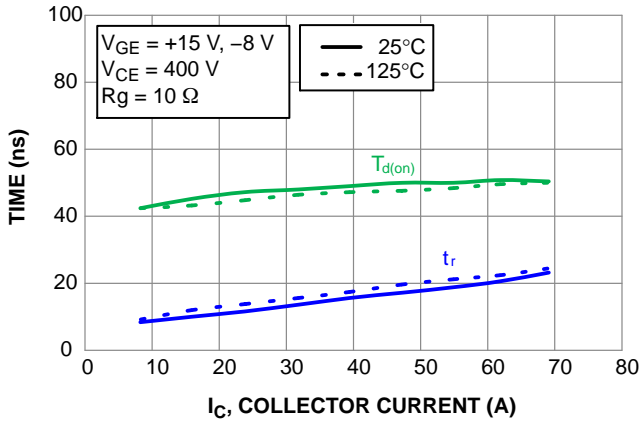

Figure 43. Typical Turn-On Switching Time vs. IC

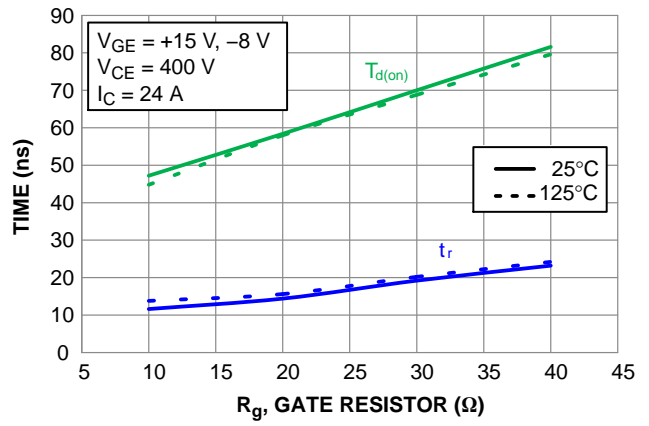

Figure 44. Typical Turn-Off Switching Time vs. Rg

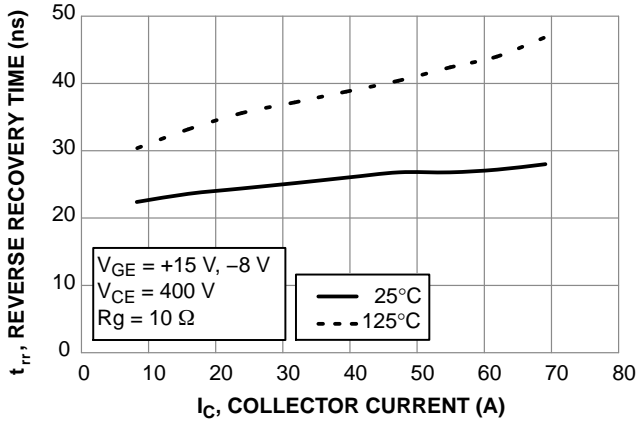

Figure 45. Typical Reverse Recovery Time vs. IC

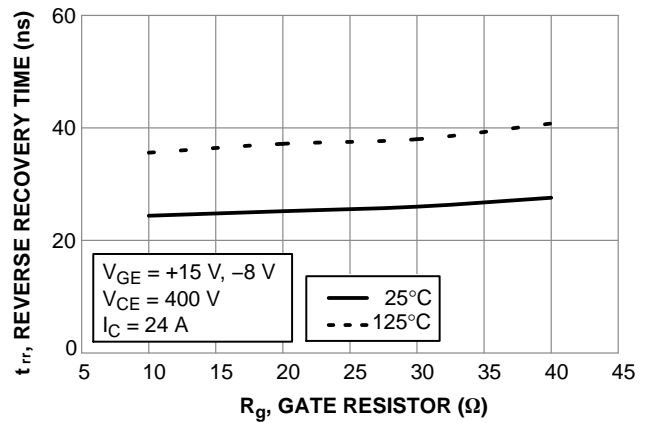

Figure 46. Typical Reverse Recovery Time vs. Rg

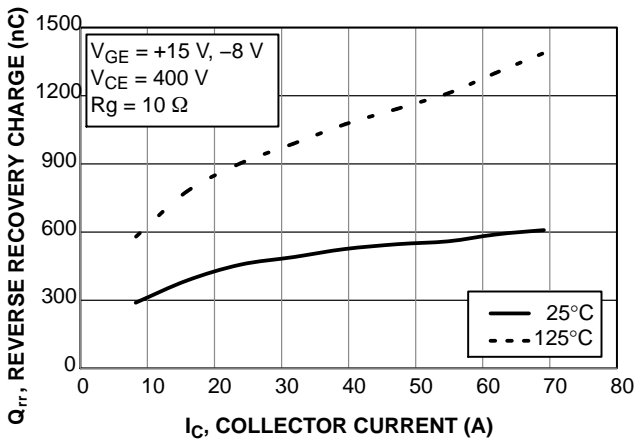

Figure 47. Typical Reverse Recovery Charge vs. IC

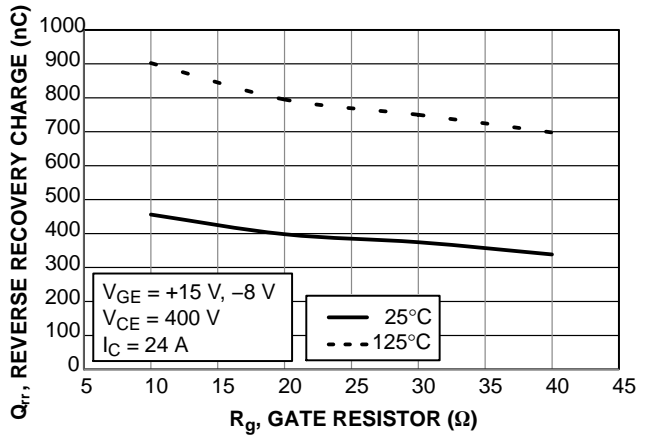

Figure 48. Typical Reverse Recovery Charge vs. Rg

# NXH50M65L4C2SG

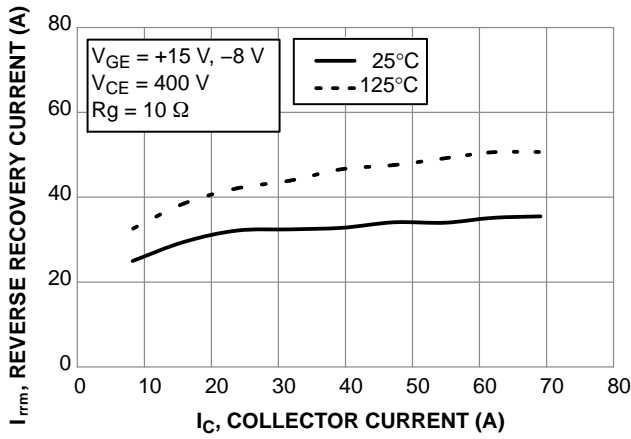

Figure 49. Typical Reverse Recovery Peak Current vs.  $I_C$

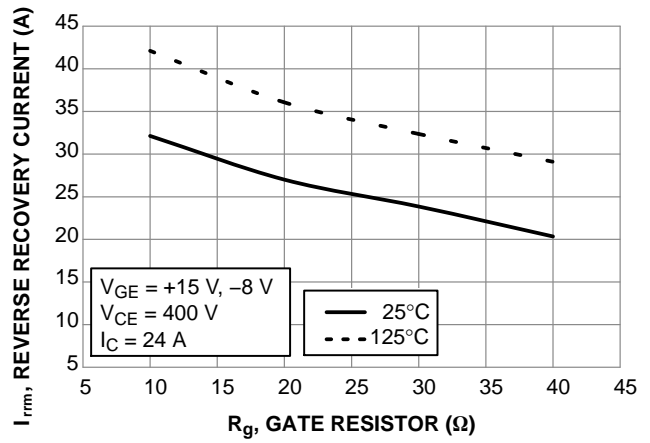

Figure 50. Typical Reverse Recovery Peak Current vs.  $R_g$

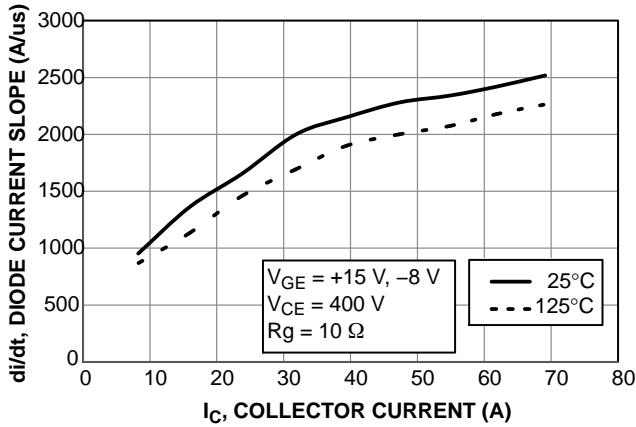

Figure 51. Typical  $di/dt$  Current Slope vs.  $I_C$

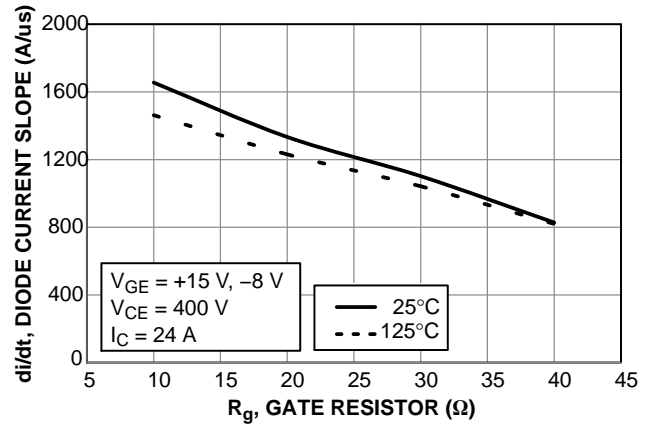

Figure 52. Typical  $di/dt$  Current Slope vs.  $R_g$

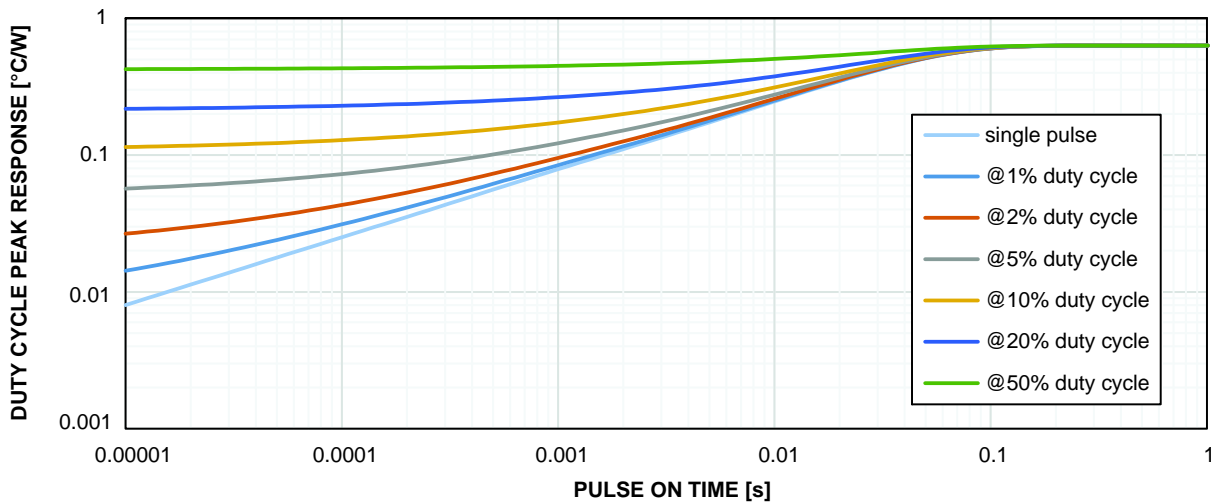

Figure 53. IGBT Junction-to-Case Transient Thermal Impedance

# NXH50M65L4C2SG

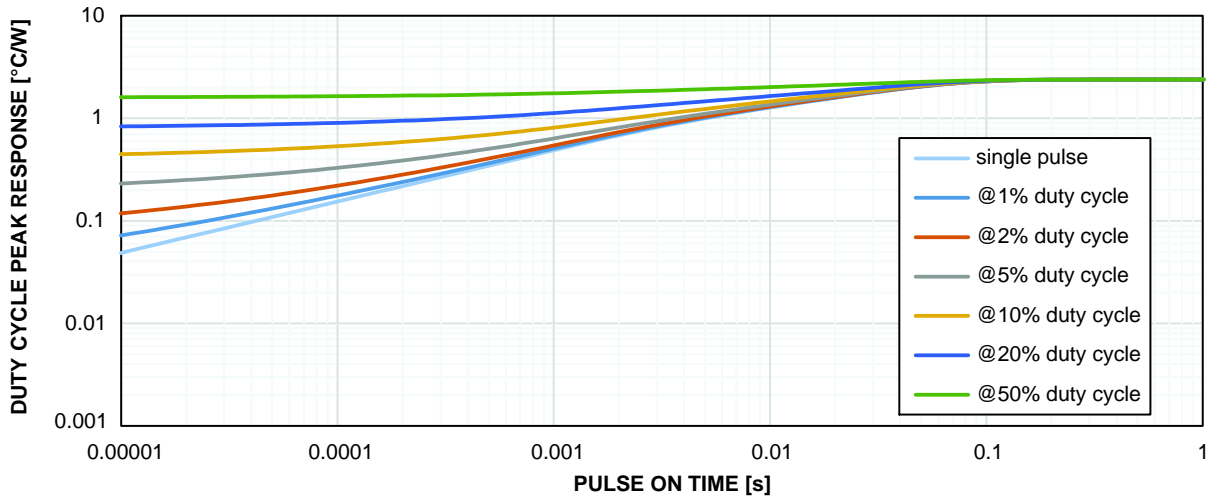

Figure 54. Diode Junction-to-Case Transient Thermal Impedance

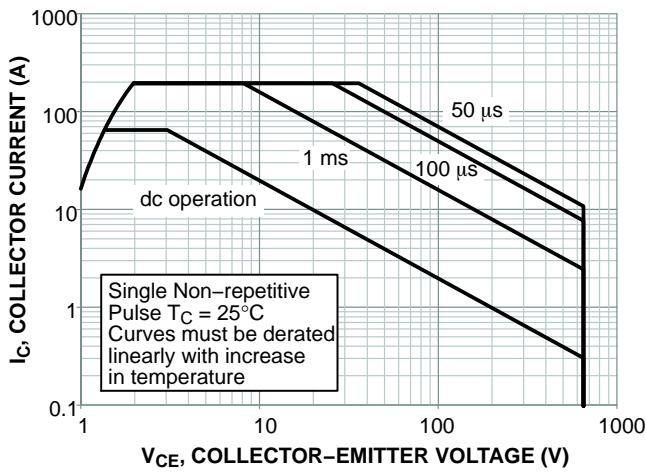

Figure 55. IGBT FBSOA

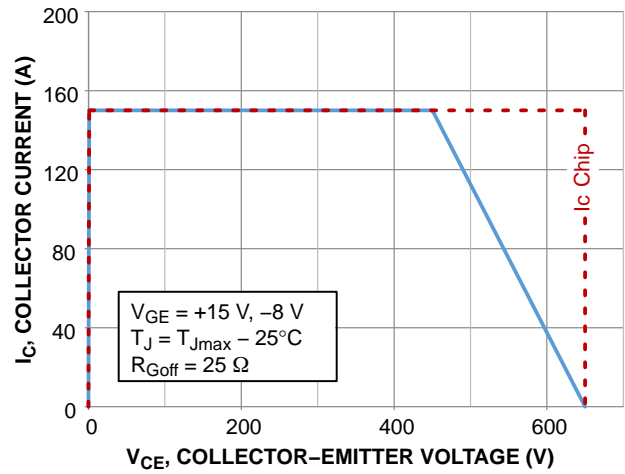

Figure 56. IGBT RBSOA

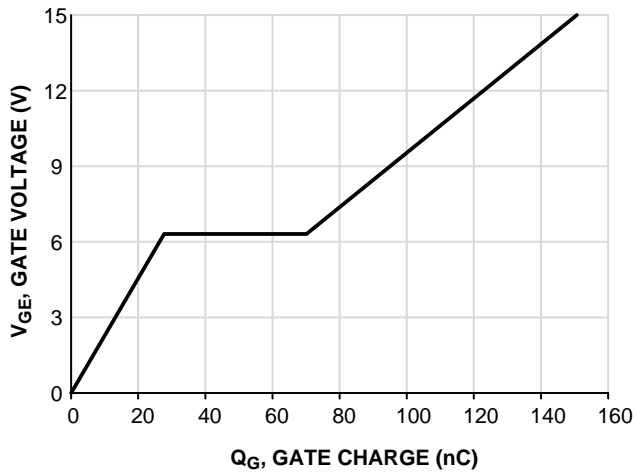

Figure 57. IGBT Gate Voltage vs. Gate Charge

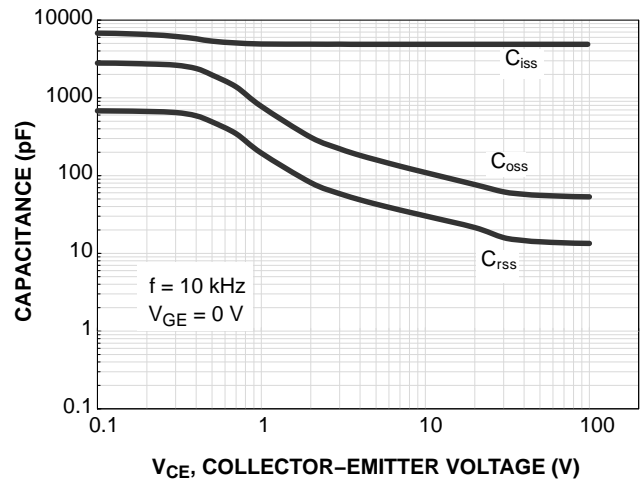

Figure 58. IGBT Capacitance vs. Collector-Emitter Voltage



# NXH50M65L4C2SG

## TYPICAL CHARACTERISTICS – D7, D8 PFC DIODE & D1 – D4 CONVERTER DIODE

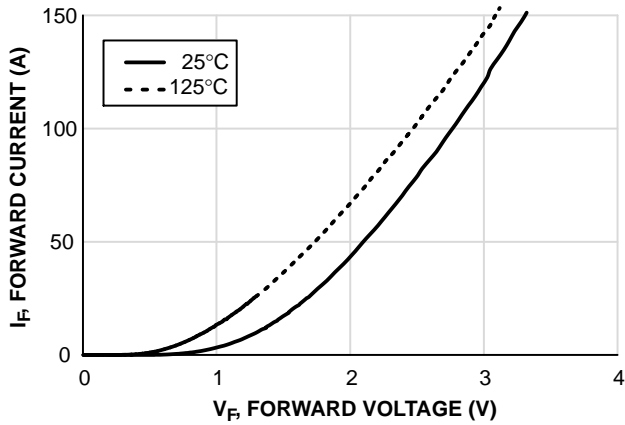

Figure 59. PFC Diode Forward Characteristics

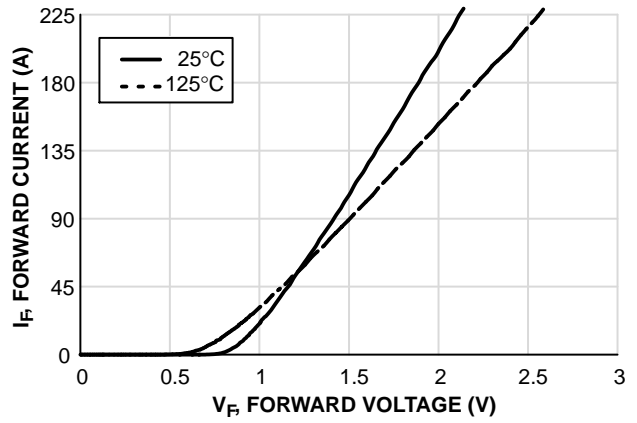

Figure 60. Converter Diode Forward Characteristics

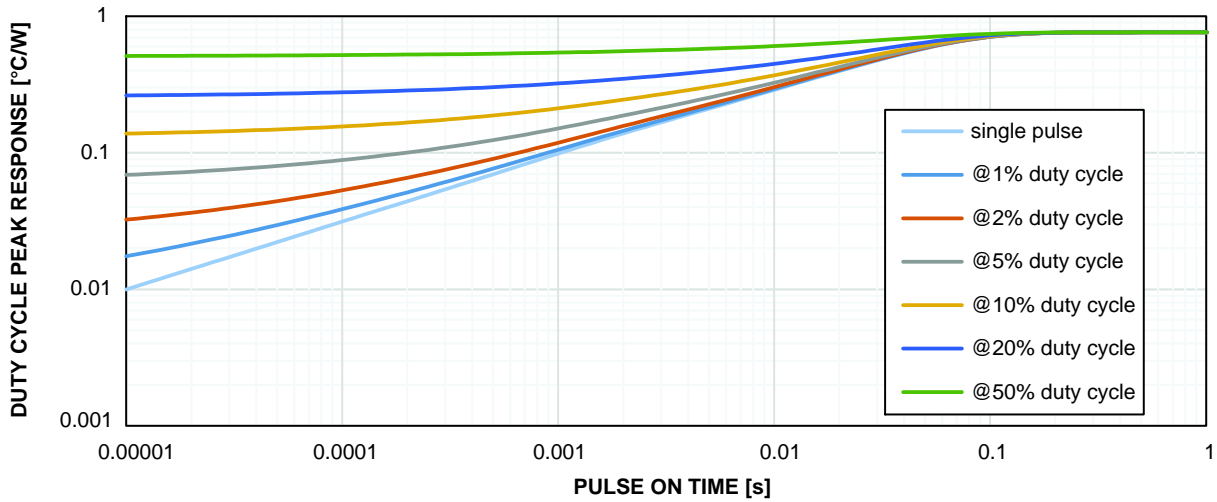

Figure 61. PFC Diode Junction-to-Case Transient Thermal Impedance

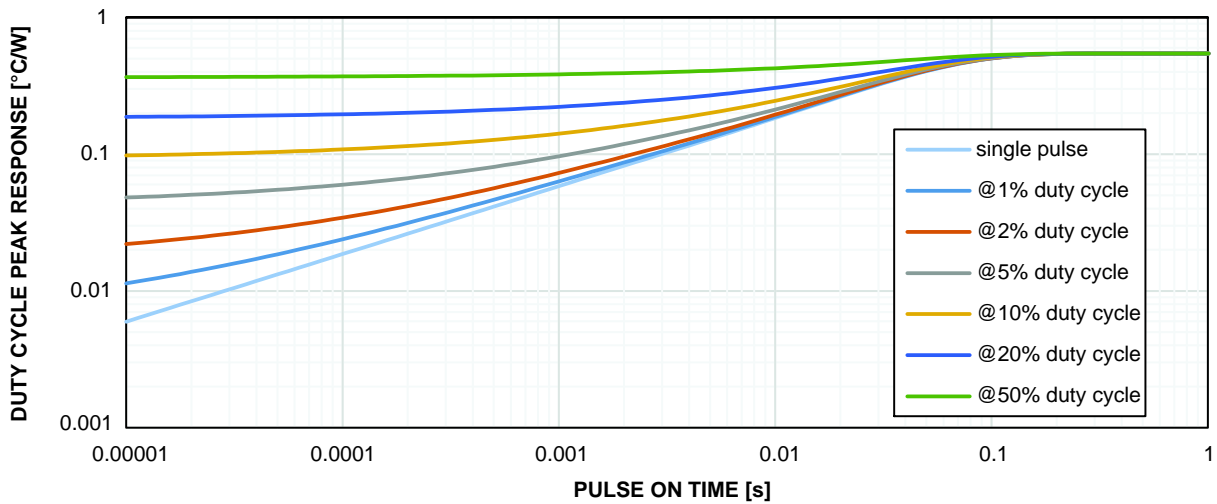

Figure 62. Converter Diode Junction-to-Case Transient Thermal Impedance

# NXH50M65L4C2SG

## ORDERING INFORMATION

Device Order Number	Specific Device Marking	Package Type	Shipping
NXH50M65L4C2SG	NXH50M65L4C2SG	DIP27 73.2x40.2 (Pb-Free)	6 Units / Tube

# MECHANICAL CASE OUTLINE

## PACKAGE DIMENSIONS

ON Semiconductor®

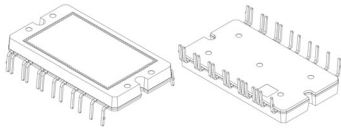

**DIP27 73.2x40.2**  
**CASE 184AA**  
**ISSUE B**

DATE 15 JUL 2021

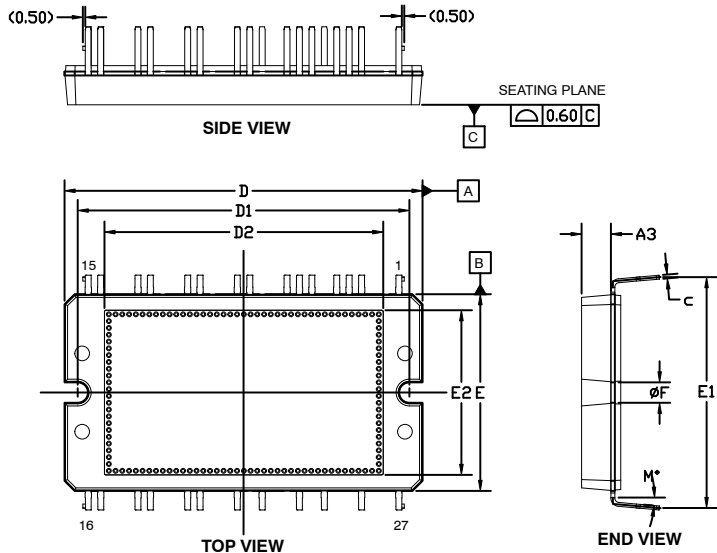

DIM	MILLIMETERS		
	MIN	NOM	MAX
A	15.50	16.00	16.50
A2	7.80	8.00	8.20
A3	6.00 REF		
b	1.10	1.20	1.30
c	0.70	0.80	0.90
D	72.70	73.20	73.70
D1	67.30	67.80	68.30
D2	57.30 REF		
E	39.70	40.20	40.70
E1	46.70	47.20	47.70
E2	33.87 REF		
e	2.54 BSC		
F	4.00	4.20	4.40
L	8.00 REF		
L1	3.50	4.00	4.50
M	4°	5°	6°

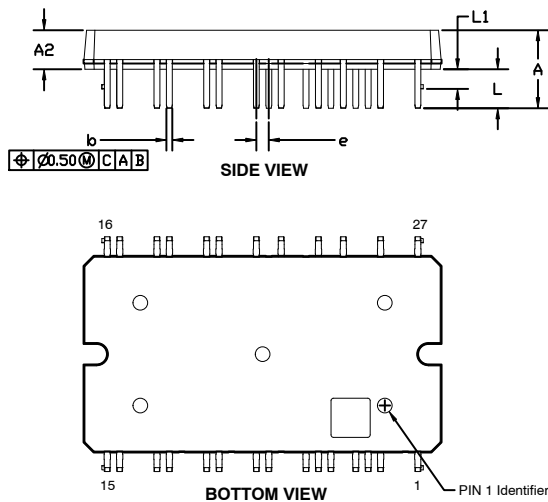

**NOTES:**

1. Dimensioning and tolerancing as per ASME Y14.5M, 2009
2. Controlling Dimension: Millimeters
3. Dimensions are exclusive of Burrs, Mold Flash, and Tiebar extrusions
4. Dimensions "b" and "c" apply to plated leads
5. Position of the leads is determine at the root of the lead where it exits the package body

**GENERIC MARKING DIAGRAM\***

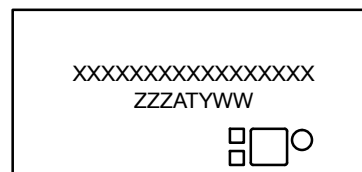

XXX = Specific Device Code  
 ZZZ = Assembly Lot Code  
 A = Assembly Site  
 T = Test Site  
 Y = Year  
 WW = Work Week

\*This information is generic. Please refer to device data sheet for actual part marking. Pb-Free indicator, "G" or microdot "▪", may or may not be present. Some products may not follow the Generic Marking.

<b>DOCUMENT NUMBER:</b>	<b>98AON23070H</b>	Electronic versions are uncontrolled except when accessed directly from the Document Repository. Printed versions are uncontrolled except when stamped "CONTROLLED COPY" in red.
<b>DESCRIPTION:</b>	<b>DIP27 73.2x40.2</b>	<b>PAGE 1 OF 1</b>

ON Semiconductor and ON are trademarks of Semiconductor Components Industries, LLC dba ON Semiconductor or its subsidiaries in the United States and/or other countries. ON Semiconductor reserves the right to make changes without further notice to any products herein. ON Semiconductor makes no warranty, representation or guarantee regarding the suitability of its products for any particular purpose, nor does ON Semiconductor assume any liability arising out of the application or use of any product or circuit, and specifically disclaims any and all liability, including without limitation special, consequential or incidental damages. ON Semiconductor does not convey any license under its patent rights nor the rights of others.

**onsemi**, **Onsemi**, and other names, marks, and brands are registered and/or common law trademarks of Semiconductor Components Industries, LLC dba "**onsemi**" or its affiliates and/or subsidiaries in the United States and/or other countries. **onsemi** owns the rights to a number of patents, trademarks, copyrights, trade secrets, and other intellectual property. A listing of **onsemi**'s product/patent coverage may be accessed at [www.onsemi.com/site/pdf/Patent-Marking.pdf](http://www.onsemi.com/site/pdf/Patent-Marking.pdf). **onsemi** reserves the right to make changes at any time to any products or information herein, without notice. The information herein is provided "as-is" and **onsemi** makes no warranty, representation or guarantee regarding the accuracy of the information, product features, availability, functionality, or suitability of its products for any particular purpose, nor does **onsemi** assume any liability arising out of the application or use of any product or circuit, and specifically disclaims any and all liability, including without limitation special, consequential or incidental damages. Buyer is responsible for its products and applications using **onsemi** products, including compliance with all laws, regulations and safety requirements or standards, regardless of any support or applications information provided by **onsemi**. "Typical" parameters which may be provided in **onsemi** data sheets and/or specifications can and do vary in different applications and actual performance may vary over time. All operating parameters, including "Typicals" must be validated for each customer application by customer's technical experts. **onsemi** does not convey any license under any of its intellectual property rights nor the rights of others. **onsemi** products are not designed, intended, or authorized for use as a critical component in life support systems or any FDA Class 3 medical devices or medical devices with a same or similar classification in a foreign jurisdiction or any devices intended for implantation in the human body. Should Buyer purchase or use **onsemi** products for any such unintended or unauthorized application, Buyer shall indemnify and hold **onsemi** and its officers, employees, subsidiaries, affiliates, and distributors harmless against all claims, costs, damages, and expenses, and reasonable attorney fees arising out of, directly or indirectly, any claim of personal injury or death associated with such unintended or unauthorized use, even if such claim alleges that **onsemi** was negligent regarding the design or manufacture of the part. **onsemi** is an Equal Opportunity/Affirmative Action Employer. This literature is subject to all applicable copyright laws and is not for resale in any manner.

## PUBLICATION ORDERING INFORMATION

### LITERATURE FULFILLMENT:

Email Requests to: [orderlit@onsemi.com](mailto:orderlit@onsemi.com)

**onsemi Website:** [www.onsemi.com](http://www.onsemi.com)

### TECHNICAL SUPPORT

**North American Technical Support:**

Voice Mail: 1 800-282-9855 Toll Free USA/Canada

Phone: 011 421 33 790 2910

**Europe, Middle East and Africa Technical Support:**

Phone: 00421 33 790 2910

For additional information, please contact your local Sales Representative