



RoHS

MESSRS: 深圳亚泽科技

APPROVAL NO

710 - 001

DATE

2020.10.24

ALUMINUM ELECTROLYTIC

# CAPACITOR

## APPROVAL SHEET

CATALOG TYPE	NXA SERIES
USER PART NO.	
适用机种	
特记事项	Halogen-Free

QINGDAO SAMYOUNG ELECTRONICS CO.,LTD.

MANAGER OF DEVELOPMENT DEPARTMENT

GONG JANG SUG



USER APPROVAL:

APPROVAL NO.: \_\_\_\_\_

SamYoung(Korea) : 47,SAGIMAKGOL-RO,JUNGWON-GU,SEONGNAM-SI,GYEONGGI-DO,KOREA

SamYoung(China) : No.5 CHANGJIANG ROAD,PINGDU-CITY,SHANDONG-PROVINCE,CHINA

样式: H-1001-011

A4 (210×297)



SamYoung Electronics Co., Ltd.

<b>APPROVAL NO.</b> <b>710 - 001</b>	<b>ALUMINUM ELECTROLYTIC CAPACITOR</b>	<b>PAGE: 1 OF 6</b>
		<b>DATE: 2020.10.24</b>

### Specifications

Item	Characteristics									
Rated Voltage Range	6.3 ~ 100 V <sub>DC</sub>									
Operating Temperature Range	- 40 ~ + 105 °C									
Capacitance Tolerance	±20% <M> (20°C ,120Hz)									
Leakage Current ( 20 °C,2 minutes )	I = 0.01CV( μA ) or 3 μA, whichever is greater Where, I: Max. Leakage current( μA ), C: Nominal capacitance ( μF ) V: Rated Voltage ( V <sub>DC</sub> )									
Dissipation Factor ( TANδ ) ( 20°C , 120Hz )	Rated voltage(V <sub>DC</sub> )	6.3	10	16	25	35	50	63	80	100
	TANδ(Max)	0.22	0.19	0.16	0.14	0.12	0.10	0.09	0.09	0.08
※ When the Capacitance exceeds 1,000μF, 0.02 shall be added every 1,000μF increase.										
Temperature Characteristics (Max. Impedance ratio)	Rated Voltage(V <sub>DC</sub> )	6.3	10	16	25	35	50	63	80	100
	Z(-25°C)/Z(20°C)	4	3	2	2	2	2	2	2	2
	Z(-40°C)/Z(20°C)	8	6	4	3	3	3	3	3	3
Load Life	The following specifications shall be satisfied when the capacitors are restored to 20°C after the rated voltage with the rated ripple current is applied (the peak voltage shall not exceed the rated voltage) at 105°C for the specified period of time.									
	Capacitance change	: ≤± 25% of the initial Value								
	TANδ	: ≤200% of the initial specified value								
	Leakage current	: ≤ The initial specified value								
		Case Size (ΦD)	6.3~10(V)		16~100(V)					
		Φ5~Φ6.3	4,000 hours		5,000 hours					
		Φ8~Φ10	6,000 hours		7,000 hours					
		Φ12.5 ~Φ18	8,000 hours		10,000 hours					
Shelf Life	The following specifications shall be satisfied when the capacitors are restored to 20°C after exposing them for 500 hours at 105°C without voltage applied. The rated voltage shall be applied to the capacitor for a minimum of 30 minutes, at least 24 hours and not more than 48 hours before the measurements.									
	Capacitance change	: ≤± 25% of the initial Value								
	TANδ	: ≤200% of the initial specified value								
	Leakage current	: ≤The initial specified value								
Others	Satisfies characteristic <b>KS C IEC 60384-4</b>									

### A. DIAGRAM OF DIMENSION

### B. MARKING: DARK BROWN SLEEVE, SILVER INK

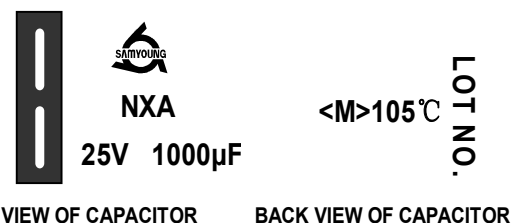
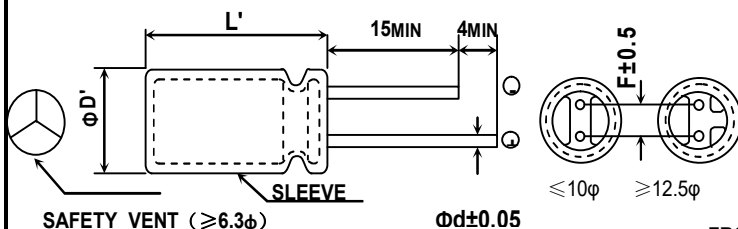

ΦD	5	6.3	8	10	12.5	16	18
Φd	0.5	0.5	0.6	0.6	0.6	0.8	0.8
F	2.0	2.5	3.5	5.0	5.0	7.5	7.5
ΦD'	ΦD+0.5max						
L'	L+1.5max			L+2.0max			

※Φ10x12L, L' ≦ L+1.5

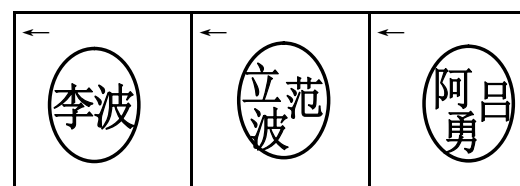

# ALUMINUM ELECTROLYTIC CAPACITOR

**APPROVAL NO:**  
**710 - 001**

## RATINGS OF NXA Series

VDC ΦD×L	6.3 WV			10 WV			16 WV			25 WV			35 WV		
	CAP.(μF)	IMP.	RIPPLE	CAP.(μF)	IMP.	RIPPLE	CAP.(μF)	IMP.	RIPPLE	CAP.(μF)	IMP.	RIPPLE	CAP.(μF)	IMP.	RIPPLE
5×11	150	0.580	210	100	0.580	210				22	0.58	120			
							56	0.580	210	33	0.58	210	33	0.580	210
							100	0.580	210	47	0.58	210	47	0.580	210
6.3×11							100	0.220	340	100	0.22	340			
	220	0.220	340	220	0.220	340	120	0.220	340	100	0.22	340	47	0.250	250
	330	0.220	340	330	0.220	340	150	0.220	340	150	0.22	340	56	0.220	340
6.3×15				470	0.220	350	330	0.220	340	220	0.22	340	100	0.220	340
							330	0.220	340	220	0.22	340			
							330	0.220	340	220	0.22	340			
8×11.5	680	0.130	640	470	0.130	640	330	0.130	640	220	0.130	640	100	0.150	500
				680	0.130	640	470	0.130	640	330	0.130	640	150	0.130	640
				1000	0.087	840	470	0.087	840	330	0.087	840	220	0.130	640
8×15				1000	0.087	840	680	0.087	840	470	0.087	840	220	0.087	840
										560	0.087	840			
										470	0.069	1050	270	0.069	1050
8×20				1200	0.069	1050	680	0.069	1050	470	0.069	1050	270	0.069	1050
										560	0.069	1050			
										680	0.069	1050	390	0.069	1050
10×12.5	820	0.080	865	680	0.080	865	470	0.080	865	330	0.080	865	220	0.080	865
				1000	0.080	865	680	0.080	865	470	0.080	865	330	0.080	865
										470	0.060	1210	330	0.060	1210
10×16	1200	0.060	1210	1000	0.060	1210	680	0.060	1210	470	0.060	1210	330	0.060	1210
							1000	0.058	1210	680	0.060	1210	470	0.060	1210
							1000	0.048	1400	680	0.048	1400	470	0.048	1400
10×20	1500	0.046	1400	1200	0.046	1400	1000	0.046	1400	820	0.046	1400	680	0.046	1400
										1000	0.046	1400	820	0.046	1400
										820	0.042	1650	680	0.042	1650
10×25															
10×30	2200	0.042	1650	1500	0.042	1650	2200	0.042	1650	1000	0.042	1650	1000	0.042	1650
	2700	0.031	1910	2200	0.031	1910	1500	0.031	1910	1000	0.031	1910	680	0.031	1910
	1800	0.049	1450	1500	0.049	1450	1000	0.049	1450	680	0.049	1450	470	0.049	1450
12.5×20				2200	0.035	1900	1500	0.035	1900	1000	0.035	1900	680	0.035	1900
	3300	0.035	1900	3300	0.035	1900	2200	0.035	1900	1500	0.035	1900	1000	0.035	1900
	3900	0.027	2230	3300	0.027	2230	2200	0.027	2230	1500	0.027	2230	1000	0.027	2230
12.5×25				4700	0.027	2230	4700	0.027	2230	2200	0.027	2230	1200	0.027	2230
12.5×30	4700	0.024	2650	3900	0.024	2650	2700	0.024	2650	1800	0.024	2650	1500	0.024	2650
12.5×35	5600	0.020	2880	4700	0.020	2880	3300	0.020	2880	2200	0.020	2880	1500	0.020	2880
	2700	0.042	1940	2200	0.042	1940	1500	0.042	1940	1000	0.042	1940	680	0.042	1940
16×20	5600	0.027	2530	3900	0.027	2530	2700	0.027	2530	1800	0.027	2530	1200	0.027	2530
				4700	0.027	2530	3300	0.027	2530	2200	0.027	2530	1500	0.027	2530
16×25															
16×31.5	6800	0.021	2930	5600	0.021	2930	4700	0.021	2930	3300	0.021	2930	2200	0.021	2930
	8200	0.017	3450	6800	0.017	3450	4700	0.017	3450	3300	0.017	3450	2200	0.017	3450
	10000	0.015	3610	8200	0.015	3610	5600	0.015	3610	3900	0.015	3610	2700	0.015	3610
16×40															
18×20	12000	0.013	4080	10000	0.013	4080	6800	0.013	4080	4700	0.013	4080	3300	0.013	4080
	6800	0.026	2860	5600	0.026	2860	3900	0.026	2860	2200	0.026	2860	1800	0.026	2860
	10000	0.019	3140	6800	0.019	3140	4700	0.019	3140	3300	0.019	3140	2200	0.019	3140
18×25	12000	0.015	4170	8200	0.015	4170	5600	0.015	4170	3900	0.015	4170	2700	0.015	4170
18×35.5															
18×40	15000	0.014	4220	10000	0.014	4220	8200	0.014	4220	5600	0.014	4220	3900	0.014	4220
	18000	0.012	4280	12000	0.012	4280	10000	0.012	4280	6800	0.012	4280	4700	0.012	4280

Rated Ripple Current (mA rms / 105°C, 100KHz)  
Impedance (Ω max. / 20°C, 100KHz)  
Nominal Capacitance(μF)

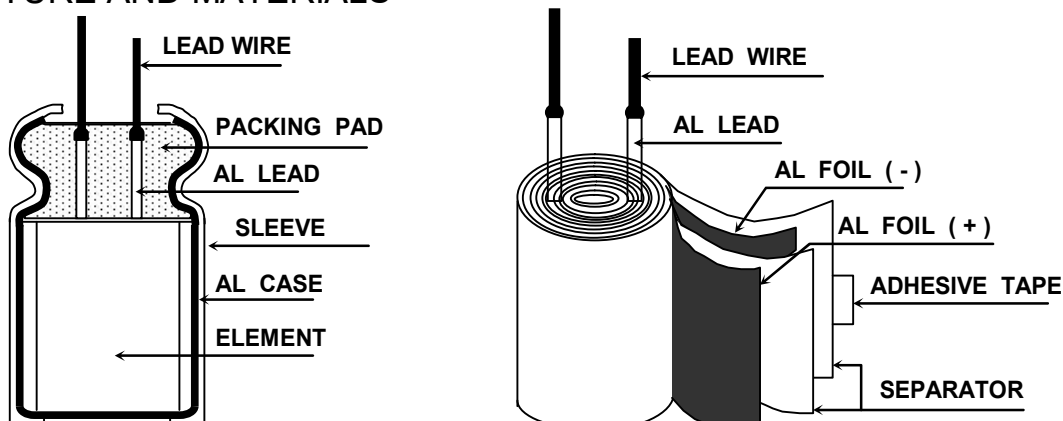
**ALUMINUM ELECTROLYTIC CAPACITORS****APPROVAL NO.**  
**710 - 001****STRUCTURE AND MATERIALS**

CE04 TYPE

MINIATURE SIZED TYPE CAPACITORS COMPONENT

PART NAME	MATERIALS	VENDER
LEAD WIRE	TINNED COPPER - PLY WIRE(Pb-FREE)	KISTRON (KOREA/CHINA) KOHOKU (JAPAN/CHINA) NANTONG HONG YANG (CHINA)
AL LEAD	ALUMINUM 99.92 % OVER	KANG WON AUTO FITTING NAN TONG HUI FENG (CHINA) NANTONG HONG YANG KOHOKU (JAPAN/CHINA) KISTRON (KOREA/CHINA)
PACKING PAD	SYNTHETIC RUBBER	SUNG NAM (KOREA/CHINA) CCW/ZHE JIANG TIAN TAI ZHE JIANG TIAN HUA (CHINA)
SLEEVE	P.E.T(Poly Ethylene Terephthalate Resin)	MOO DEUNG (KOREA/CHINA) SUZHOU QILIAN SHUN PENG PLASTIC (CHINA) YUN LIN PLASTIC
AL CASE	ALUMINUM 99.0 % OVER	ZHANG JIA GANG LIAN YI LIN AN AO XING (CHINA) NANTONG CHUANGJIA DONG NAM D.N TECH/HA NAM (KOREA/CHINA)
AL FOIL ⊕	FORMED ALUMINUM 99.9 % OVER	K.D.K/JCC/MATSUSHITA (JAPAN) SAM YOUNG (KOREA) BECROMAL (ITALY) SATMA (FRANCE) HEC XINJIANG JOINWORLD (CHINA) HUAFENG / NANTONG /RAOIO LUXON/LITON (TAIWAN)
AL FOIL ⊖	ETCHED ALUMINUM 98.0 % OVER	K-JCC (KOREA) K.D.K (JAPAN) AFT/INCULCU/SHENGHONG ELECEN/WU JIANG FEILO (CHINA)
SEPARATOR	INSULATION PAPER	KAN/LUNAN (CHINA) SPO (GERMANY) N.K.K (JAPAN)
ADHESIVE TAPE	POLY PROPYLENE OR POLY IMIDE FILM	NITTO/NICHIBAN (JAPAN) DAEIL/SWECO (KOREA)

**ALUMINUM ELECTROLYTIC CAPACITOR****APPROVAL NO.****710 - 001**

Taping Dimensions: 2.5mm T/P (6.3Φ)

【UNIT: mm】

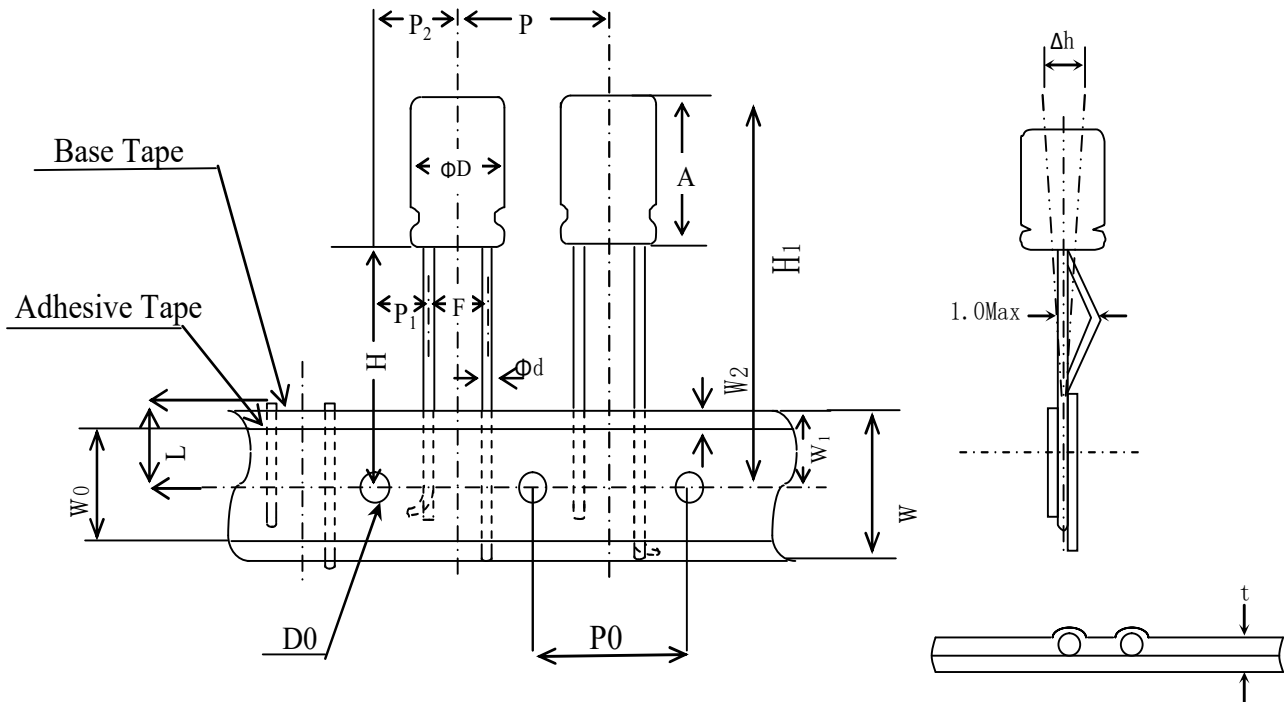

Items	Dimensions	Tolerance	Remarks
$\Phi D$	6.3	$\pm 0.5$	
$A$	11/15	+1.5	
$\Phi d$	0.5	$\pm 0.05$	
$P$	12.7	$\pm 1$	
$P_0$	12.7	$\pm 0.2$	Cumulative pitch error : 1mm/20pitch
$P_1$	5.1	$\pm 0.7$	
$P_2$	6.35	$\pm 1$	
$F$	2.5	+0.8 -0.2	
$\Delta h$	0	$\pm 2.0$	
$W$	18	$\pm 0.5$	
$W_0$	10Min	-	
$W_1$	9	$\pm 0.5$	
$W_2$	1.5 Max	-	Not to protrude over base tape
$H$	18.5	$\pm 0.75$	
$H_1$	$H+A$	-	Check insertion machine specs
$D_0$	4	$\pm 0.2$	
$t$	0.7	$\pm 0.2$	
$L$	11.0MAX	-	



## When using aluminum electrolytic capacitors, pay strict attention to the following:

### 1. Electrolytic capacitors for DC application require polarization.

Confirm the polarity. If used in reversed polarity, the circuit life may be shortened or the capacitor may be damaged. For use on circuits whose polarity is occasionally reversed, or whose polarity is unknown, use bi-polarized capacitors (BP-series). Also, note that the electrolytic capacitor cannot be used for AC application.

### 2. Do not apply a voltage exceeding the capacitor's voltage rating.

If a voltage exceeding the capacitor's voltage rating is applied, the capacitor may be damaged as leakage current increases. When using the capacitor with AC voltage superimposed on DC voltage, care must be exercised that the peak value of AC voltage does not exceed the rated voltage.

### 3. Do not allow excessive ripple current to pass.

Use the electrolytic capacitor at current values within the permissible ripple range. If the ripple current exceeds the specified value, request capacitors for high ripple current applications.

### 4. Ascertain the operating temperature range.

Use the electrolytic capacitors according to the specified operating temperature range. Usage at room temperature will ensure longer life.

### 5. The electrolytic capacitor is not suitable for circuits in which charge and discharge are frequently repeated.

If used in circuits in which charge and discharge are frequently repeated, the capacitance value may drop, or the capacitor may be damaged. Please consult our engineering department for assistance in these applications.

### 6. Apply voltage treatment to the electrolytic capacitor which has been allowed to stand for a long time.

If the electrolytic capacitor is allowed to stand for a long time, its withstand voltage is liable to drop, resulting in increased leakage current. If the rated voltage is applied to such a product, a large leakage current occurs and this generates internal heat, which damaged the capacitor. If the electrolytic capacitor is allowed to stand for a long time, therefore, use it after giving voltage treatment (Note 1). (However, no voltage treatment is required if the electrolytic capacitor is allowed to stand for less than 2 or 3 years at normal temperature.)

### 7. Be careful of temperature and time when soldering.

When soldering a printed circuit board with various components, care must be taken that the soldering temperature is not too high and that the dipping time is not too long. Otherwise, there will be adverse effects on the electrical characteristics and insulation sleeve of electrolytic capacitors in the case of small-sized electrolytic capacitors, nothing abnormal will occur if dipping is performed at less than 260°C for less than 10 seconds.

### 8. Do not place a soldering iron on the body of the capacitor.

The electrolytic capacitor is covered with a vinyl sleeve. If the soldering iron comes in contact with the electrolytic capacitor body during wiring, damage to the vinyl sleeve and/or case may result in defective insulation, or improper protection of the capacitor element.

### 9. Cleaning circuit boards after soldering.

Some solvents have adverse effects on capacitors.  
Please refer to the next page.

### 10. Do not apply excessive force to the lead wires or terminals.

If excessive force is applied to the lead wires and terminals, they may be broken or their connections with the internal elements may be affected. (For strength of terminals, refer to KS C IEC 60384-4 (JIS C5101-1, JIS C5101-4))

### 11. Care should be used in selecting a storage area.

If electrolytic capacitors are exposed to high temperatures caused by such things as direct sunlight, the life of the capacitor may be adversely affected. Storage in a high humidity atmosphere may affect the solderability of lead wires and terminals.

### 12. Surge voltage.

The surge voltage rating is the maximum DC over-voltage to which the capacitor may be subjected for short periods not exceeding approximately 30 seconds at infrequent intervals of not more than six minutes. According to KS C IEC 60384-4, the test shall be conducted 1000 cycles at room temperature for the capacitors of characteristic KS C IEC 60384-4 or at the maximum operating temperature for the capacitors of characteristics B and C of KS C IEC 60384-4 with voltage applied through a series resistance of 1000 ohms without discharge. The electrical characteristics of the capacitor after the test are specified in KS C IEC 60384-4. Unless otherwise specified, the rated surge voltage are as follows:

Rated Voltage(V)	2	4	6.3	10	16	25	35	50	63	80	100	160	200	250	315	350	400	450	500
Rated Surge Voltage(V)	2.5	5	8	13	20	32	44	63	79	100	125	200	250	300	365	400	450	500	550

**Note 1 Voltage treatment** ... Voltage treatment shall be performed by increasing voltage up to the capacitor's voltage rating gradually while lowering the leakage current. In this case, the impressed voltage shall be in the range where the leakage current of the electrolytic capacitor is less than specified value. Meanwhile, the voltage treatment time may be effectively shortened if the ambient temperature is increased (within the operating temperature range).

**Note 2 For methods of testing**, refer to KS C IEC 60384-4, (JIS C 5101-1, JIS C 5101-4)



## CLEANING CONDITIONS

Aluminum electrolytic capacitors that have been exposed to halogenated hydrocarbon cleaning and defluxing solvents are susceptible to attack by these solvents. This exposure can result in solvent penetration into the capacitors, leading to internal corrosion and potential failure.

Common type of halogenated cleaning agents are listed below.

Chemical Name	Structural Formula	Representative Brand Name
Trichlorotrifluoroethane	C <sub>2</sub> Cl <sub>3</sub> F <sub>3</sub>	Freon TF, Daiflon S-3
Fluorotrichloromethane	CCl <sub>3</sub> F	Freon-11, Daiflon S-1
1,1,1-Trichloroethane	F <sub>2</sub> H <sub>3</sub> Cl <sub>3</sub>	Chloroethane
Trichloroethylene	C <sub>2</sub> HCl <sub>3</sub>	Trichlene
Methyl Chloride	CH <sub>3</sub> Cl	MC

We would like to recommend you the below cleaning materials for your stable cleaning condition taking the place of previous materials.

© Isopropyl Alcohol (IPA) or Water

Cleaning method: One of immersion, ultrasonic or vapor cleaning.

Maximum cleaning time: 5 minutes (Chip type: 2 minutes)

※ Do not use AK225AES

Aluminum electrolytic capacitors are easily affected by halogen ions, particularly by chloride ions. Excessive amounts of halogen ions, if happened to enter the inside of the capacitors, will give corrosion accidents-rapid capacitance drop and vent open. The extent of corrosion accidents varies with kinds of electrolytes and seal-materials. Therefore, the prevention of halogen ion contamination is the most important check point for quality control in our production lines. At present, halogenated hydrocarbon-contained organic solvents such as Trichloroethylene, 1,1,1-Trichloroethane, and Freon are used to remove flux from circuit boards.

If electrolytic capacitors are cleaned with such solvents, they may gradually penetrate the seal portion and cause the ejection. When using latex-based adhesive on the capacitors rubber end seal for adhesion to a PCB, corrosion may occur depending on the kind of solvent in the adhesive. Select an adhesive as an organic solvent with dissolved polymer that is not halogenated hydrocarbon. Hot air drying is required for eliminating the solvent between the product and the PCB at 50°C~80°C after coating.

Followings are the penetration path of the halogenated solvent.

- ① Penetration between the rubber and the aluminum case
- ② Penetration between the rubber and the lead wire
- ③ Penetration through the rubber

The inside of the capacitors, the mechanism of corrosion of aluminum electrolytic capacitors by halogen ions can be explained as follows:

Halides (RX) are absorbed and diffused into the seal portion. The halides then enter the inside of the capacitors and contact with the electrolyte of the capacitors. Where by halogen ions are made free by a hydrolysis with water in the electrolyte:

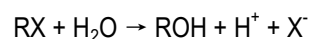

The halogen ions (X<sup>-</sup>) react with the dielectric substance (Al<sub>2</sub>O<sub>3</sub>) of aluminum electrolytic capacitors:

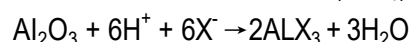

ALX<sub>3</sub> is dissociated with water:



### ※ MANUFACTURING SITE

- SamYoung Electronics Co., Ltd. (Korea/China)

