

RF Transistor

30 V, 300 mA, $f_T = 3.5$ GHz, NPN Single PCP

2SC5551A

Features

- High f_T : ($f_T = 3.5$ GHz Typ)
- Large Current: ($I_C = 300$ mA)
- Large Allowable Collector Dissipation (1.3 W Max)
- These are Pb-Free Devices

Product & Package Information

- Package: PCP
- JEITA, JEDEC: SC-62, SOT-89, TO-243
- Minimum Packing Quantity: 1,000 Pcs./Reel

Specifications

ABSOLUTE MAXIMUM RATINGS (at $T_a = 25^\circ\text{C}$)

Parameter	Symbol	Conditions	Ratings	Unit
Collector-to-Base Voltage	V_{CBO}		40	V
Collector-to-Emitter Voltage	V_{CEO}		30	V
Emitter-to-Base Voltage	V_{EBO}		2	V
Collector Current	I_C		300	mA
Collector Current (Pulse)	I_{CP}		600	mA
Collector Dissipation	P_C	When mounted on ceramic substrate (250 mm ² x 0.8 mm)	1.3	W
Junction Temperature	T_J		150	°C
Storage Temperature	T_{stg}		-55 to +150	°C

Stresses exceeding those listed in the Maximum Ratings table may damage the device. If any of these limits are exceeded, device functionality should not be assumed, damage may occur and reliability may be affected.

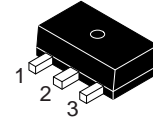

- 1: Base
- 2: Collector
- 3: Emitter

SOT-89 / PCP-1
CASE 419AU

MARKING DIAGRAM

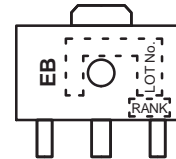

ELECTRICAL CONNECTION

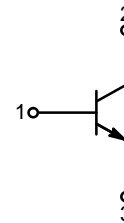

ORDERING INFORMATION

Device	Package	Shipping†
2SC5551AE-TD-E	PCP (Pb-Free)	1,000 / Tape & Reel
2SC5551AF-TD-E	PCP (Pb-Free)	1,000 / Tape & Reel

†For information on tape and reel specifications, including part orientation and tape sizes, please refer to our Tape and Reel Packaging Specifications Brochure, BRD8011/D.

2SC5551A

ELECTRICAL CHARACTERISTICS (at Ta = 25°C)

Parameter	Symbol	Conditions	Ratings			Unit
			Min	Typ	Max	
Collector Cutoff Current	I_{CBO}	$V_{CB} = 20\text{ V}, I_E = 0\text{ A}$	–	–	1.0	μA
Emitter Cutoff Current	I_{EBO}	$V_{EB} = 1\text{ V}, I_C = 0\text{ A}$	–	–	5.0	μA
DC Current Gain	h_{FE1}	$V_{CE} = 5\text{ V}, I_C = 50\text{ mA}$	90	–	270	
	h_{FE2}	$V_{CE} = 5\text{ V}, I_C = 300\text{ mA}$	20	–	–	
Gain–Bandwidth Product	f_T	$V_{CE} = 5\text{ V}, I_C = 50\text{ mA}$	–	3.5	–	GHz
Output Capacitance	C_{ob}	$V_{CB} = 10\text{ V}, f = 1\text{ MHz}$	–	2.9	4.0	pF
Reverse Transfer Capacitance	C_{re}		–	1.5		pF
Collector–to–Emitter Saturation Voltage	$V_{CE(sat)}$	$I_C = 50\text{ mA}, I_B = 5\text{ mA}$	–	0.07	0.3	V
Base–to–Emitter Saturation Voltage	$V_{BE(sat)}$	$I_C = 50\text{ mA}, I_B = 5\text{ mA}$	–	0.8	1.2	V

Product parametric performance is indicated in the Electrical Characteristics for the listed test conditions, unless otherwise noted. Product performance may not be indicated by the Electrical Characteristics if operated under different conditions.

*The 2SC5551A is classified by 50 mA h_{FE} as follows :

Table 1.

Rank	E	F
h_{FE}	90 to 180	135 to 270

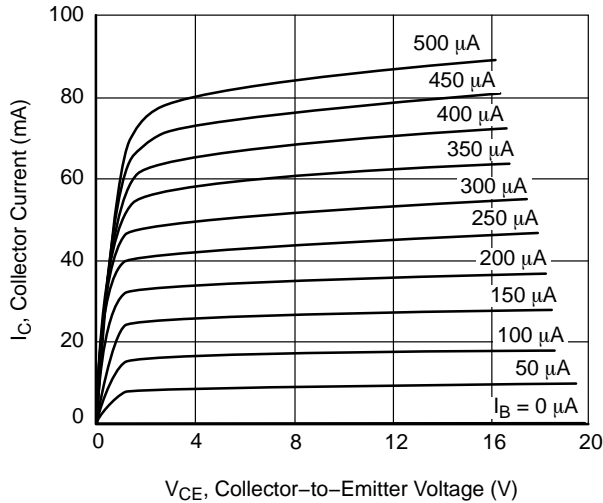

Figure 1. $I_C - V_{CE}$

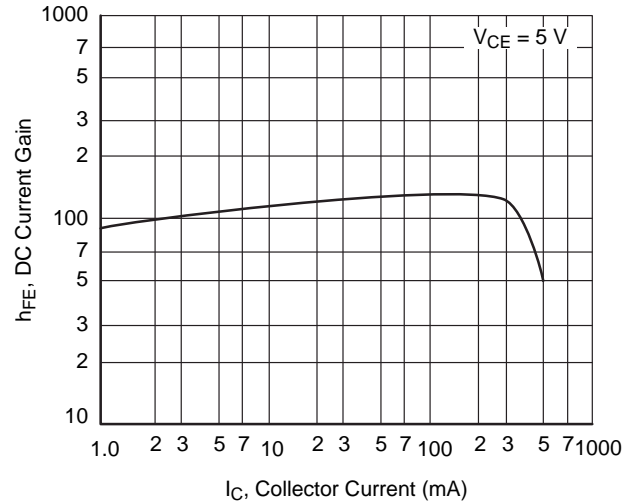

Figure 2. $h_{FE} - I_C$

2SC5551A

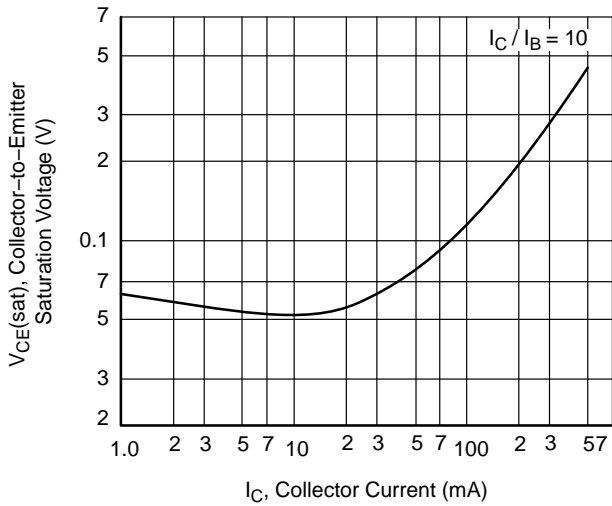

Figure 3. $V_{CE(sat)} - I_C$

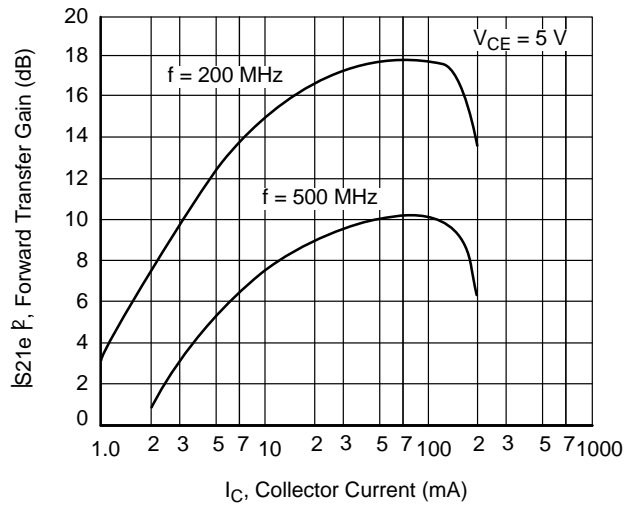

Figure 4. $|S_{21e}|^2 - I_C$

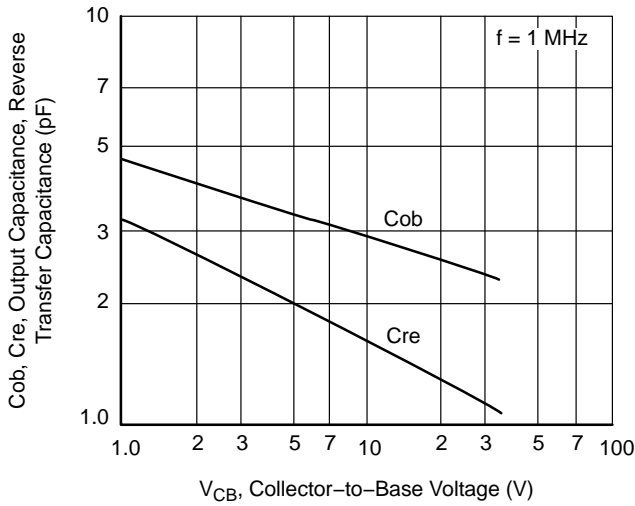

Figure 5. $C_{ob}, C_{re} - V_{CB}$

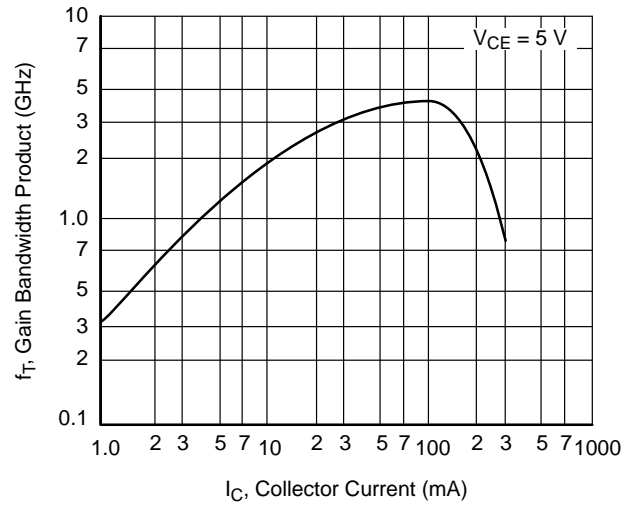

Figure 6. $f_T - I_C$

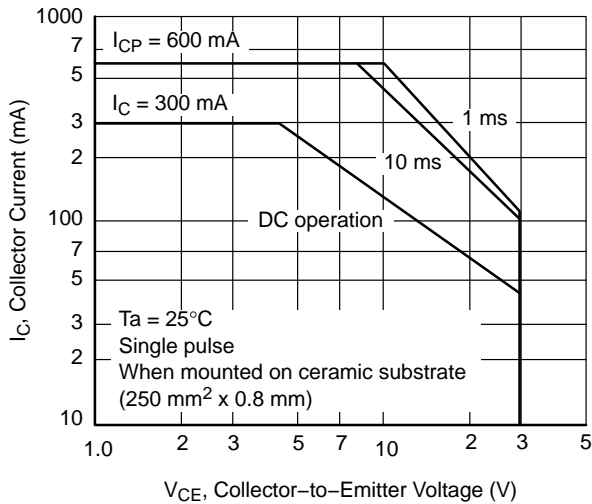

Figure 7. ASO

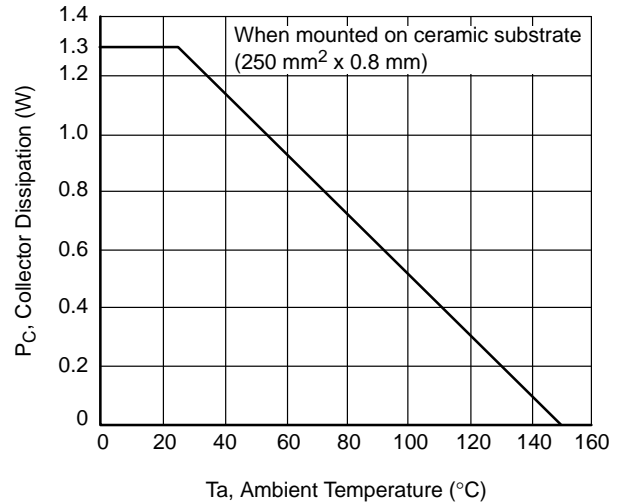

Figure 8. $P_C - T_a$

2SC5551A

Land Pattern Example

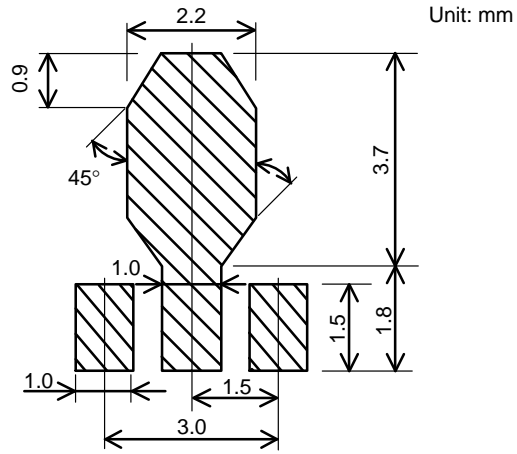
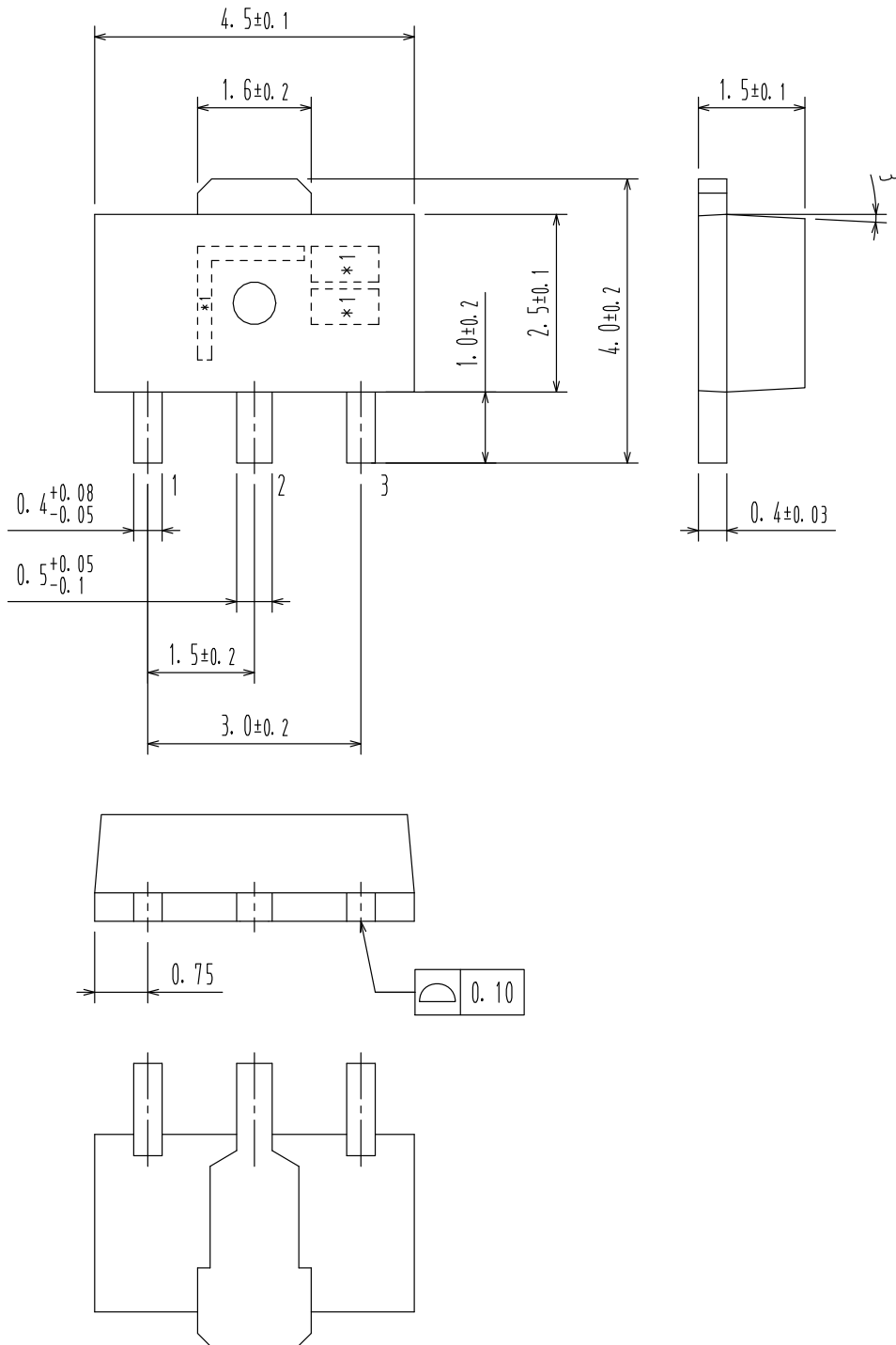

Figure 9. Land Pattern Example

MECHANICAL CASE OUTLINE
PACKAGE DIMENSIONS

SOT-89 / PCP-1
CASE 419AU
ISSUE 0

DATE 30 APR 2012



DOCUMENT NUMBER:	98AON79746E	Electronic versions are uncontrolled except when accessed directly from the Document Repository. Printed versions are uncontrolled except when stamped "CONTROLLED COPY" in red.
DESCRIPTION:	SOT-89 / PCP-1	PAGE 1 OF 1

ON Semiconductor and  are trademarks of Semiconductor Components Industries, LLC dba ON Semiconductor or its subsidiaries in the United States and/or other countries. ON Semiconductor reserves the right to make changes without further notice to any products herein. ON Semiconductor makes no warranty, representation or guarantee regarding the suitability of its products for any particular purpose, nor does ON Semiconductor assume any liability arising out of the application or use of any product or circuit, and specifically disclaims any and all liability, including without limitation special, consequential or incidental damages. ON Semiconductor does not convey any license under its patent rights nor the rights of others.

onsemi, **Onsemi**, and other names, marks, and brands are registered and/or common law trademarks of Semiconductor Components Industries, LLC dba "**onsemi**" or its affiliates and/or subsidiaries in the United States and/or other countries. **onsemi** owns the rights to a number of patents, trademarks, copyrights, trade secrets, and other intellectual property. A listing of **onsemi**'s product/patent coverage may be accessed at www.onsemi.com/site/pdf/Patent-Marking.pdf. **onsemi** reserves the right to make changes at any time to any products or information herein, without notice. The information herein is provided "as-is" and **onsemi** makes no warranty, representation or guarantee regarding the accuracy of the information, product features, availability, functionality, or suitability of its products for any particular purpose, nor does **onsemi** assume any liability arising out of the application or use of any product or circuit, and specifically disclaims any and all liability, including without limitation special, consequential or incidental damages. Buyer is responsible for its products and applications using **onsemi** products, including compliance with all laws, regulations and safety requirements or standards, regardless of any support or applications information provided by **onsemi**. "Typical" parameters which may be provided in **onsemi** data sheets and/or specifications can and do vary in different applications and actual performance may vary over time. All operating parameters, including "Typicals" must be validated for each customer application by customer's technical experts. **onsemi** does not convey any license under any of its intellectual property rights nor the rights of others. **onsemi** products are not designed, intended, or authorized for use as a critical component in life support systems or any FDA Class 3 medical devices or medical devices with a same or similar classification in a foreign jurisdiction or any devices intended for implantation in the human body. Should Buyer purchase or use **onsemi** products for any such unintended or unauthorized application, Buyer shall indemnify and hold **onsemi** and its officers, employees, subsidiaries, affiliates, and distributors harmless against all claims, costs, damages, and expenses, and reasonable attorney fees arising out of, directly or indirectly, any claim of personal injury or death associated with such unintended or unauthorized use, even if such claim alleges that **onsemi** was negligent regarding the design or manufacture of the part. **onsemi** is an Equal Opportunity/Affirmative Action Employer. This literature is subject to all applicable copyright laws and is not for resale in any manner.

PUBLICATION ORDERING INFORMATION

LITERATURE FULFILLMENT:

Email Requests to: orderlit@onsemi.com

onsemi Website: www.onsemi.com

TECHNICAL SUPPORT

North American Technical Support:

Voice Mail: 1 800-282-9855 Toll Free USA/Canada

Phone: 011 421 33 790 2910

Europe, Middle East and Africa Technical Support:

Phone: 00421 33 790 2910

For additional information, please contact your local Sales Representative