

**SMD CRYSTAL UNIT SPECIFICATIONS**

<b>Customer</b>	
<b>Customer P/N</b>	
<b>Product</b>	2016 Seam Sealing Crystal
<b>Nominal Frequency</b>	26.000000MHz
<b>HOSONIC P/N</b>	E1SB26E000015E
<b>Version</b>	10C0
<b>Issue Date</b>	2016/12/1

<b>HOSONIC</b>		
<b>Drawn</b>	<b>Checked</b>	<b>Approved</b>
<b>LUCY</b>	<b>ZOE</b>	<b>JOHN</b>

**Approved By Customer :** \_\_\_\_\_



**HOSONIC ELECTRONIC CO., LTD.**



Revised Record

Rev.	Rev. Date	Item	Content	Remark
1.0	2016-12-01		Initial released	

**I ELECTRICAL PARAMETERS**

Electrical characteristics measured by S&amp;A250B or equivalent.

No.	Item	Symb.	Electrical Specification				Remark	
			Min.	Typ.	Max.	Units		
1	Nominal Frequency	F0	26.000000			MHz		
2	Mode of Vibration		Fundamental					
3	Frequency Tolerance	$\Delta F/F0$	-10	-	10	ppm	At 25°C±3°C	
4	Operating Temperature Range	T <sub>OPR</sub>	-30	-	85	°C		
5	Frequency Stability (over operating temperature)	TC	-10	-	10	ppm	Ref. to 25°C	
6	Storage Temperature	T <sub>STG</sub>	-55	-	125	°C		
7	Load capacitance	CL	-	8	-	pF		
8	Equivalent Series Resistance	ESR	-	-	80	Ω		
9	Drive Level	DL	-	50	100	μW		
10	Insulation Resistance	IR	500	-	-	MΩ	At 100V <sub>DC</sub>	
11	Shunt Capacitance	C0	-	-	3	pF		
12	Aging Per Year	Fa	-2	-	2	ppm	First Year	
13	Package type	E1SB						

**NOTE: Storage Temperature is only for the product itself, the temperature for the packing material is -4~40°C.**

**I OUTLINE DIMENSIONS (UNIT: mm)**

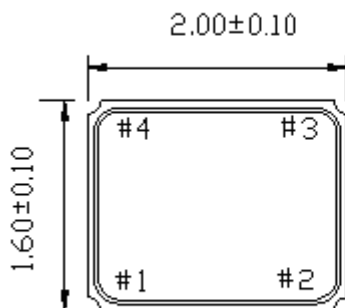

**Top View**

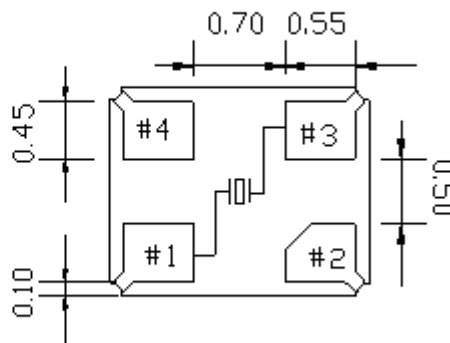

**Recommended Solder Pattern**

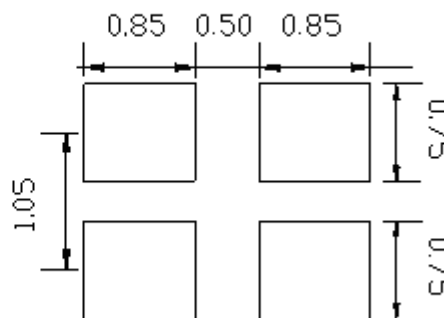
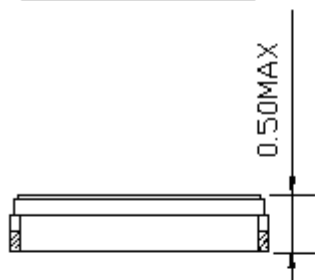

Pin	Connection
#1,#3	X'tal
#2,#4	GND

**I MARKING**

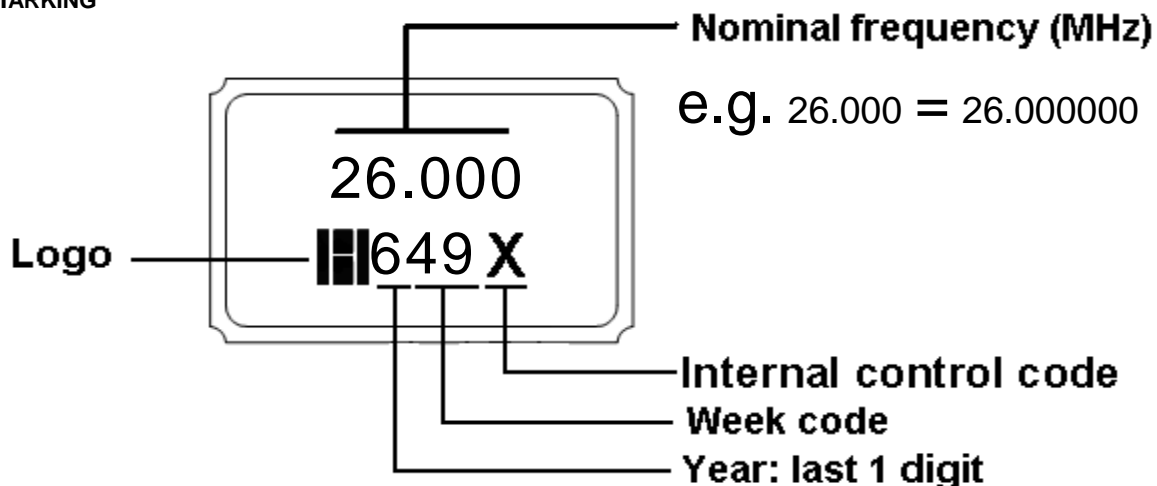

**NOTE:** The internal control code maybe blank.

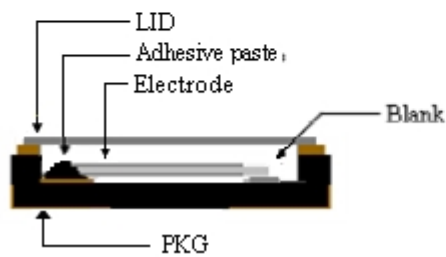
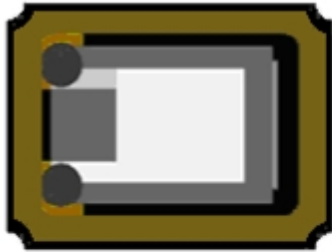
**I PRODUCT LAYOUT**

NO.	PART	MATERIAL	REMARK
1	LID	KOVAR(Fe+Co+Ni alloy)	
2	PKG	Al <sub>2</sub> O <sub>3</sub>	Base
3	Blank	SiO <sub>2</sub>	Quartz
4	Adhesive paste	Ag/Silicon	Support
5	Electrode	Noble metal	

**I REFLOW PROFILES**

Profiles Feature	Pb-Free Assembly
Average Ramp-up Rate (Ts max to Tp)	3°C/second max.
Preheat <ul style="list-style-type: none"> <li>■ Temperature Min (Ts min)</li> <li>■ Temperature Max (Ts max)</li> <li>■ Time (ts min to ts max)</li> </ul>	125°C 200°C 60~180 seconds
Time maintained above <ul style="list-style-type: none"> <li>■ Temperature (TL)</li> <li>■ Time (tL)</li> </ul>	217°C 60~150 seconds
Peak/Classification Temperature (Tp)	260°C
Time within 5°C of actual Peak Temperature (tp)	20~40 seconds
Ramp-down rate	6°C/second max.
Time 25°C to Peak Temperature	8 minutes max.
<b>Suggest reflow times</b>	<b>3 Times max</b>

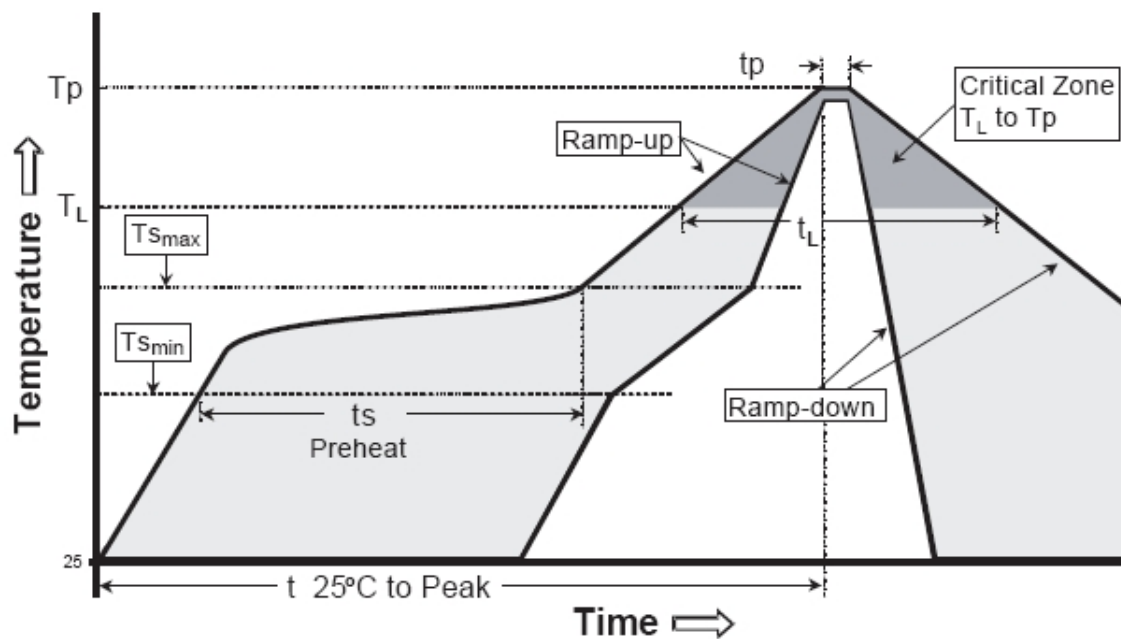

**Remark: To reference JEDEC J-STD-020C**

**I PACKAGE(reference to EIA-481)**

*Tape Dimensions(unit : mm)*

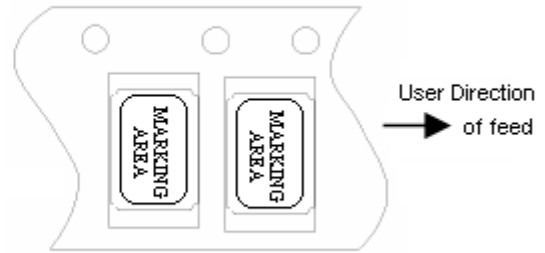
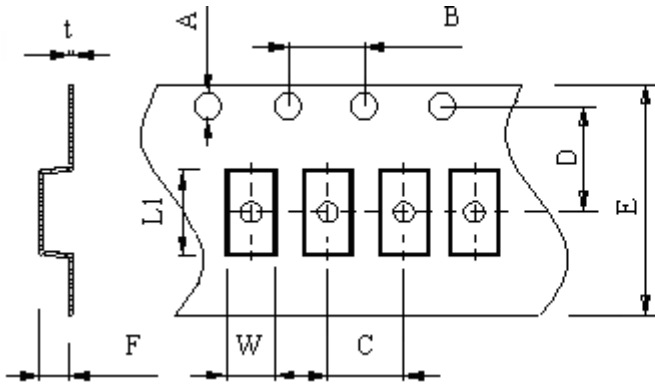

Start & End Point

A	B	C	D	E	F	L1	W	t
1.50	4.0	4.0	3.5	8.0	0.65	2.25	1.85	0.2

*Reel Dimensions(unit: mm)*

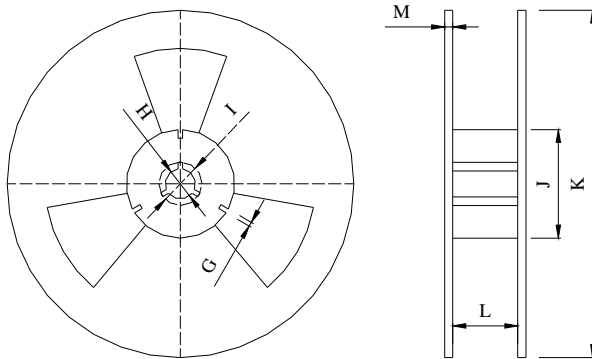

G	H	I	J	K	L	M
2.5	13.5	21.6	60.0	178	9.5	1.6

\*3000pcs/Reel

Carton Dimension (unit : mm)



1 reel = 1 Inner box

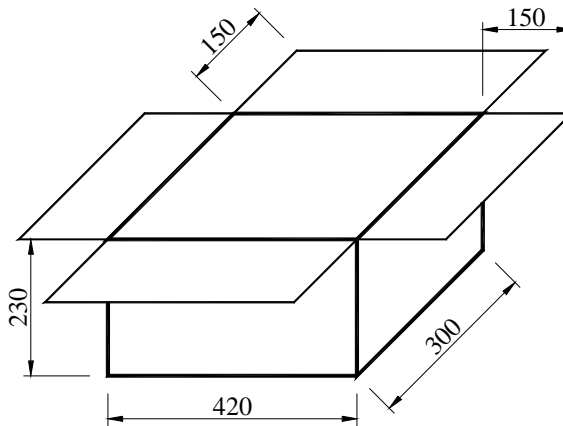
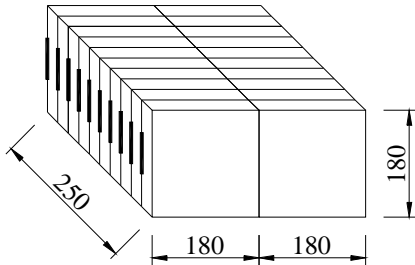

20 Inner boxes = 1 Carton

60kpcs = 1 Carton



**I RELIABILITY SPECIFICATIONS**

No.	Test Item	Test Conditions	Reference
1	High Temperature Storage	Temperature: $125^{\circ}\text{C} \pm 5^{\circ}\text{C}$ Time: $1000 \pm 12$ Hours	MIL-STD-883E-1016
2	Temperature Cycle	Temperature 1: $-55^{\circ}\text{C} \pm 5^{\circ}\text{C}$ Temperature 2: $125^{\circ}\text{C} \pm 5^{\circ}\text{C}$ Temperature change between T1 and T2 at soonest Run 1000 cycles, maintain T1 and T2 5minutes each in one cycle	JESD22 Method JA-104
3	Solder Heat Resistance	Pre-heat: $125^{\circ}\text{C}$ 60~120 Seconds Solder Temperature: $260^{\circ}\text{C} \pm 5^{\circ}\text{C}$ Time: 30 Seconds	MIL-STD-202F 210 E
4	Drop Test	3 Times Free Fall from 75cm height table to 3cm thickness hard wood board	MIL-STD-202F-203B
5	High Temperature, High Humidity Storage	Temperature: $85^{\circ}\text{C} \pm 5^{\circ}\text{C}$ Relative Humidity: 80%~85% Time: 250Hours $\pm$ 24 Hours	MIL-STD-202F-103B
6	Steam Aging	Temperature: $97^{\circ}\text{C} \pm 5^{\circ}\text{C}$ Time: 24 Hours $260^{\circ}\text{C}$ solder pot to check solderability	MIL-STD-883 C-1008.2B
7	Solderability	Dip in flux 5~10 seconds Temperature: $245^{\circ}\text{C} \pm 5^{\circ}\text{C}$ Time: 10 Seconds	MIL-STD-202F-208H
8	Aging	Temperature: $85^{\circ}\text{C} \pm 5^{\circ}\text{C}$ Time: $250 \pm 12$ Hours	MIL-STD-202 F-108A
9	Thermal Shock	Temperature 1: $-55^{\circ}\text{C} \pm 5^{\circ}\text{C}$ Temperature 2: $125^{\circ}\text{C} \pm 5^{\circ}\text{C}$ Temperature change between T1 and T2: 5 seconds 100 cycles, maintain T1 and T2 for 30 minutes each in one cycle	MIL-STD-883E-1011.9B
10	Vibration	Frequency Range: 10Hz~2000Hz Amplitude: 1.5mm or 20G 4Hours in each direction, total 12Hours	MIL-STD-202F-204D