



江苏浩都频率科技有限公司
JIANGSU HD-CRYSTAL TECHNOLOGY CO., LTD

Specifications For Product

TYPE : Quartz Crystal Oscillator
SPEC : QMEMS2016/24.000M/1.8V/±30PPM
P/N : 8T024000101
VER : A/1

R&D APPR. SIGNATURED			DEPT. 
ISSUE	CHECK	APPROVAL	
吴佳斌	程心婷	王秋贞	

Jiangsu HD-Crystal technology CO., Ltd

Add: NO 3, Dongxu Road, Lingang City, Jiangyin, Jiangsu Procince

Tel : +86 510 86680199

Fax : +86 510 86680699

Product Description

8T024000101

1. Scope:

- 1.1 This specification applies to the RoHS crystal oscillator with a frequency of 24.000MHz which will be used in electronic equipment.



2. Construction:

- 2.1 Oscillators series: QMEMS2016 8T series
2.2 Package: SMD 2.0×1.6

3. Electrical Characteristics

- | | | |
|------|---|---|
| 3.1 | Nominal Frequency: | 24.000MHz |
| 3.2 | Frequency Stability: | ±30ppm |
| | (incl. 25°C tolerance, tolerance over operating temperature range, input voltage change, load change, 1 year aging) | |
| 3.3 | Aging: | ±3ppm/year |
| 3.4 | Operating Temperature Range: | -40 to + 85°C |
| 3.5 | Storage Temperature Range: | -55 to + 125°C |
| 3.6 | Input Voltage (V_{DD}): | +1.8Vdc±10% |
| 3.7 | Input Current (I_{DD}): | 20mA max |
| 3.8 | Output Waveform: | CMOS |
| 3.9 | Output Symmetry: | 50±10% |
| 3.10 | Rise/Fall Time: | 8ns max |
| 3.11 | Output Voltage V_{OL} : | 10%VDD |
| | V_{OH} : | 90%VDD |
| 3.12 | Output Load: | 15pF |
| 3.13 | Output State Control: | Enable/disable |
| 3.14 | Start-up Time: | 10ms max |
| 3.15 | Standby current: | 10µA max |
| 3.16 | Phase Jitter (rms): | 1ps rms max 12kHz to 20MHz max |
| 3.17 | Oscillation mode: | Fundamental |
| 3.18 | Others: | Not recommended for safety applications |

Reliability Specification

NO.	ITEM	SPECIFICATION	TEST METHOD
4.1	Temperature Cycle (GB/T 2423.22-2002, Method Nb)	Frequency change after test $\leq\pm$ 5ppm.	10 cycles from -55°C to 125°C. Measurement taken after DUT being left at room temperature for 24 \pm 2 hours.
4.2	Low Temperature Storage (GB/T 2423.1-2001, Method Aa)	Frequency change after test $\leq\pm$ 5ppm.	Spending 72 hrs at -55°C \pm 3°C constant temperature. Measurement taken after DUT being left at room temperature for 24 \pm 2 hours.
4.3	High Temperature Storage (GB/T 2423.2-2001, Method Ba)	Frequency change after test $\leq\pm$ 5ppm.	Spending 72 hrs at 125°C \pm 3°C constant temperature. Measurement taken after DUT being left at room temperature for 24 \pm 2 hours.
4.4	Humidity (GB/T 2423.3-2006, Method Cab)	Frequency change after test $\leq\pm$ 5ppm.	Spending 96 hrs at 40 °C \pm 3 °C, with 90 \pm 3% R.H. Measurement taken after DUT being left at room temperature for 24 \pm 2 hours.
4.5	Vibration (GB/T 2423.10-1995, Method Fc)	Frequency change after test $\leq\pm$ 5ppm.	Apply 0.75mm vibration at sweep frequency 10~500 Hz, for 2h. 10 cycles in each direction of 3 axis. Measurement taken after 1 hour.
4.6	Shock (GB/T 2423.5-1995, Method Ea)	Frequency change after test $\leq\pm$ 5ppm. No visible damages.	Peak 1000m/s ² , normal width 6ms half sine wave form, 3.7m/s, 3 perpendicular axis of samples, 3 cycles / direction, total 18 cycles. Measurement taken after 1 hour.
4.7	Drop (GB/T 2423.8-1995, Method Ed)	Frequency change after test $\leq\pm$ 5ppm. No visible damages.	Free drop to the wooden plate from 1.0 m heights for 3 times.
4.8	Solderability (GB/T 2423.28-2005, Method Tc)	Terminals shall be covered more than 95% with solder.	In 245 \pm 5°C solder bath for 2 \pm 0.5 seconds. There is no need to do functioned test. 8-12X magnifier.
4.9	Terminal Strength (JIS-C-6429 Method 1 & 2)	No visible damage	Mount on a glass-epoxy board (100x50x1.6mm), then bend to 2mm displacement (velocity 1mm/sec) and keep for 5 seconds. or pulling force 0.5 kg for at least 60 seconds.
4.10	Resistance to Soldering Heat (GB/T 2423.28-2005, Test Tb Method 1B)	Frequency change after test $\leq\pm$ 5ppm.	Passed through the re-flow oven under the following condition. Preheat to 150°C \pm 5°C for 60 to 120sec, and peak 265°C \pm 5°C for 10s \pm 3sec. Measurement taken after DUT being left at room temperature for at 24 \pm 2 hours.
4.11	OTHERS		

Package Outline Dimensions

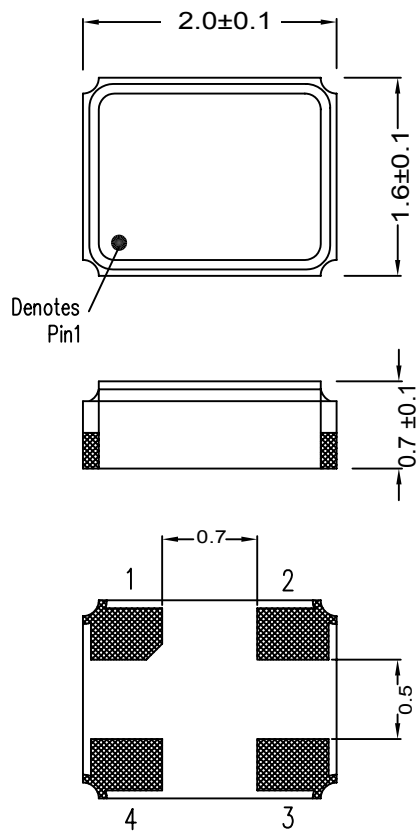

PIN CONNECTION

P/N	Features
1	Enable/Disable*
2	GND
3	Output
4	VDD

Packing Specification

