

SuperDiode – 500mW, 50nS SOD-123 Fast Switching Diode



1. Features

- Fast switching device ($T_{rr} < 50ns$)
- Power dissipation of 500mW
- High stability and high reliability
- Low reverse leakage

2. Mechanical Data

- SOD-323 Small Outline Plastic Package
- Polarity: Color band denotes cathode end
- Mounting Position: Any
- Epoxy:94V-0

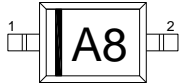
3. Marking and Circuit

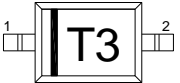
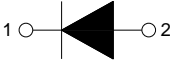
BAV19W	BAV20W	BAV21W	Circuit
			

4. Specification

Absolute Maximum Rating & Thermal Characteristics

Ratings at 25 °C ambient temperature unless otherwise specified.

Parameters	Symbol	Value			Unit
		BAV19W	BAV20W	BAV21W	
Reverse voltage	V_R	120	200	250	V
Peak reverse voltage	V_{RM}	100	150	250	V
Power dissipation	P_D	500			mW
Operating junction temperature	T_J	150			°C
Storage temperature range	T_S	-65~150			°C
Thermal resistance from junction to ambient	$R_{\theta JA}$	250			°C/W
Working Inverse Voltage	WIV	75			V
Average rectified current	I_O	200			mA
Peak forward surge current @ $t_p=1ms$	I_{FSM}	2.5			A
Non-repetitive peak forward current	I_{FM}	400			mA

Valid provided that electrodes are kept at ambient temperature

Electrical Characteristics (At TA = 25°C unless otherwise specified)

Symbols	Parameter	Test Condition	Limits		Unit
			Min	Max	
V _{RB}	Reverse Breakdown Voltage	I _R =100uA	BAV19W	120	V
			BAV20W	200	
			BAV21W	250	
I _R	Reverse Leakage Current	V _R =100V	BAV19W	0.1	uA
		V _R =150V	BAV20W		
		V _R =200V	BAV21W		
V _F	Forward Voltage	I _F =100mA		1.00	V
		I _F =200mA		1.25	
T _{RR}	Reverse Recovery Time	I _F = I _R =30mA		50	ns
		R _L =100Ω			
		I _{RR} =3mA			
C _T	Junction Capacitance	V _R =0V, f=1MHZ		5	pF

5. Typical Characteristic

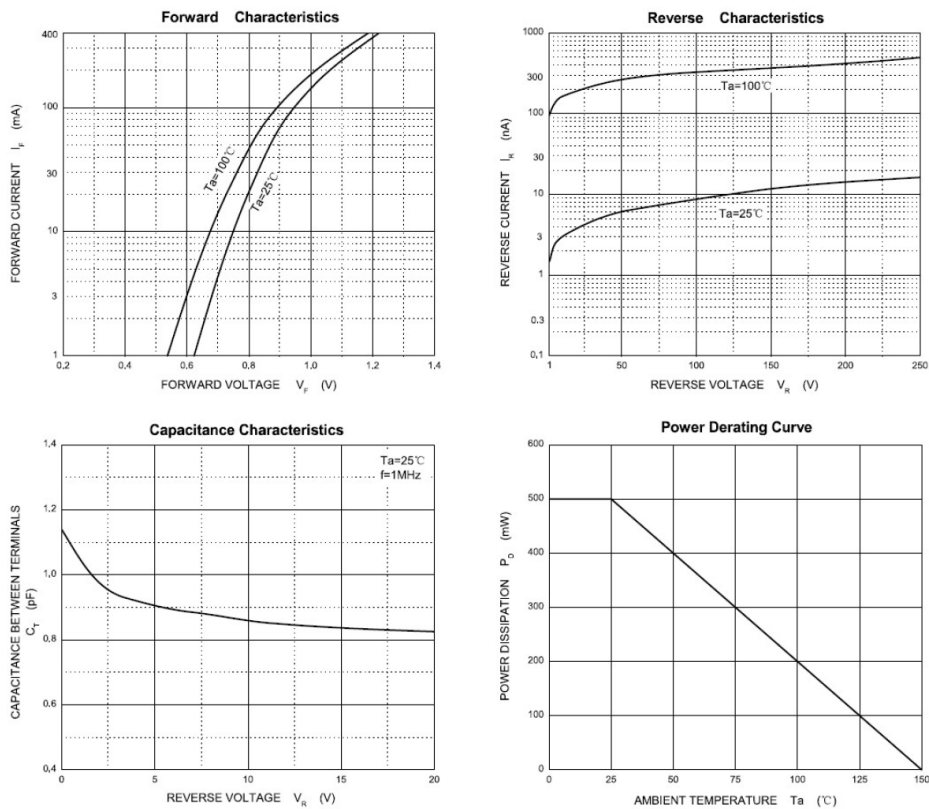

6. Dimension and Patterns (SOD-123)

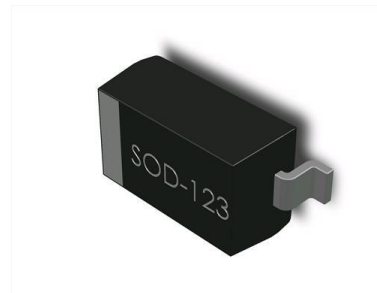
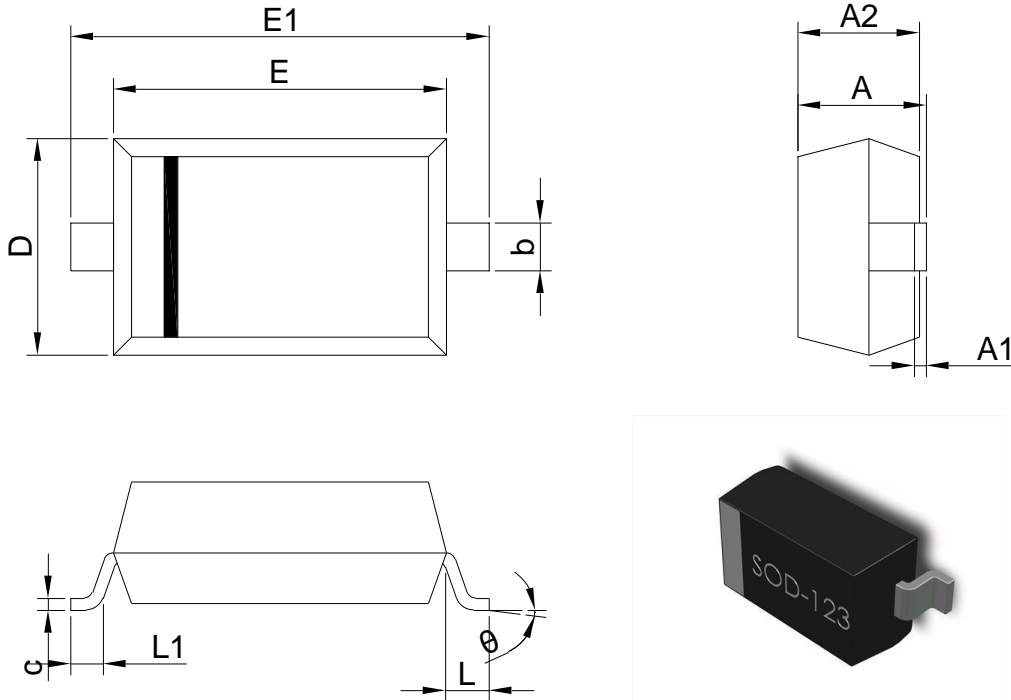

Units: mm

Symbol	Min.	Max.	Symbol	Min.	Max.
A	1.05	1.25	E	2.60	2.80
A1	0.00	0.10	E1	3.55	3.85
A2	1.05	1.15	L	0.50REF	
b	0.45	0.65	L1	0.25	0.45
c	0.08	0.15	θ	0°	8°
D	1.50	1.70			

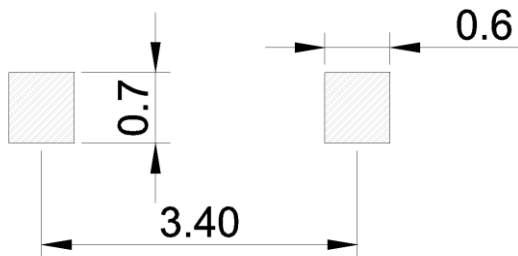

Note:

1. Controlling dimension: in millimeters
2. General tolerance: ±0.05mm
3. The pad layout is for reference only
4. Unit: mm

DISCLAIMER

ELECSUPER PROVIDES TECHNICAL AND RELIABILITY DATA (INCLUDING DATASHEETS), DESIGN RESOURCES (INCLUDING REFERENCE DESIGNS), APPLICATION OR OTHER DESIGN ADVICE, SAFETY INFORMATION, AND OTHER RESOURCES "AS IS" AND WITH ALL FAULTS, AND DISCLAIMS ALL WARRANTIES, EXPRESS AND IMPLIED, INCLUDING WITHOUT LIMITATION ANY IMPLIED WARRANTIES OF MERCHANTABILITY, FITNESS FOR A PARTICULAR PURPOSE OR NON-INFRINGEMENT OF THIRD PARTY INTELLECTUAL PROPERTY RIGHTS.

These resources are intended for skilled developers designing with ElecSuper products. You are solely responsible for

- (1) selecting the appropriate ElecSuper products for your application;
- (2) designing, validating and testing your application;
- (3) ensuring your application meets applicable standards, and any other safety, security, or other requirements.

These resources are subject to change without notice. ElecSuper grants you permission to use these resources only for development of an application that uses the ElecSuper products described in the resource. Other reproduction and display of these resources are prohibited. No license is granted to any other ElecSuper intellectual property right or to any third party intellectual property right. ElecSuper disclaims responsibility for, and you will fully indemnify ElecSuper and its representatives against, any claims, damages, costs, losses, and liabilities arising out of your use of these resources. ElecSuper's products are provided subject to ElecSuper's Terms of Sale or other applicable terms available either on www.elecsuper.com or provided in conjunction with such ElecSuper products. ElecSuper's provision of these resources does not expand or otherwise alter ElecSuper's applicable warranties or warranty disclaimers for ElecSuper products.