

NOTES:

SPECIFICATION:

1. RATING: 3.0V 5.0A
2. VOLTAGE: 100 VAC FOR 1 min
3. TEMPERATURE RANGE: -20 °C ~ 85 °C
4. CONTACT RESISTANCE: 40 MILLIONHM MAX
5. INSULATION RESISTANCE: 100 MEGOHMS MIN.
6. INSERTION FORCE: 5N~20N
7. UNMATING FORCE: 6N~20N
8. DURABILITY: 10,000 CYCLES
9. WATER PROOFNESS: THIS PRODUCT IS BASED ON IPX7.

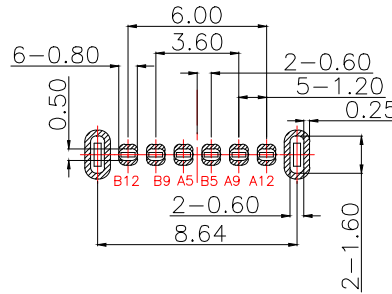
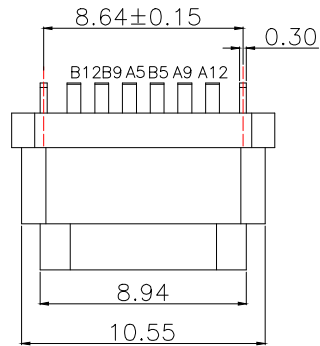

PCB Layout(Pattern side)

A5	CC1	B12	GND
A9	VBUS	B9	VBUS
A12	GND	B5	CC2
PIN	SIGNAL NAME	PIN	SIGNAL NAME

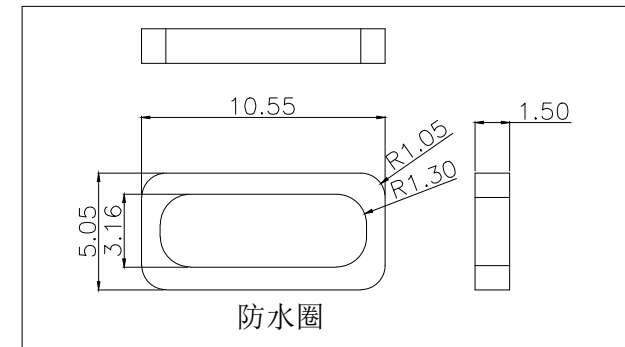
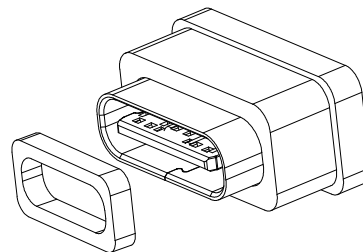
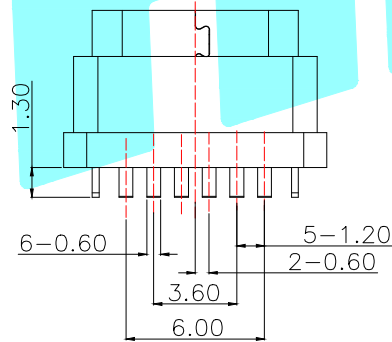
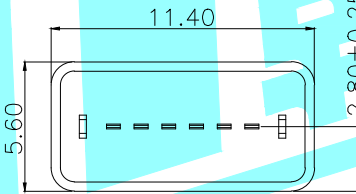
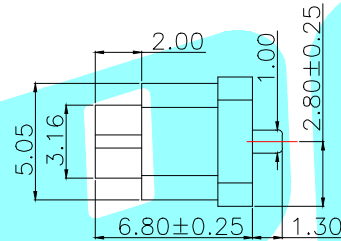
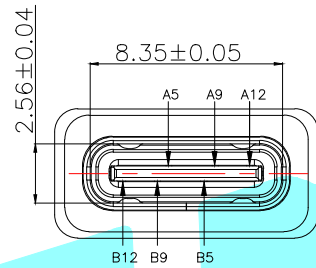

⑤	防水圈	—	1	硅胶	Black
④	Shell	—	1	SUS	Ni Plated
③	Mid Plate	—	1	SUS	Natural
②	Contact	—	1	COPPER ALLOY	TIN/Au/NI Plated
①	Housing	—	1	LCP	Black
ITEM	PART NAME	TER'NO.	QTY.	MATERIAL	FINISHING

APPROVALS		DATE		 ELECTRONICS CO.,LTD		
DRAWN	LIUCAN	2022.8.16				
CHECKED				TITLE:	USB CONNECTOR	
APPROVALS				PART NO.	TYPE-C-31-E-11B	
TOLERANCES ARE	30~以上	±0.30	ANGLE	UNIT: mm	SCALE: 1:1	PROJ:
	10~30	±0.25				
	5~10	±0.20	±2'	DRAWING NO.		SHEET 1 OF 1
	~ 5	±0.15				

_____	A	_____	NEW	_____	_____	_____
ECN NO.	REV.	DATE.	DESCRIPTION.	CHANGE.	CHECK.	APPRO.