

N-Channel Trench Power MOSFET

General Description

The JY2312 uses advanced trench technology to provide excellent $R_{DS(ON)}$, low gate charge and operation with gate voltages as low as 2.5V. This device is suitable for use as a battery protection or in other switching application.

Features

- $V_{DS} = 20V, I_D = 6A$
 $R_{DS(ON)} < 26m\Omega @ V_{GS} = 4.5V$
 $R_{DS(ON)} < 34m\Omega @ V_{GS} = 2.5V$
- High Power and current handing capability
- Lead free product is acquired
- Surface Mount Package

Application

- Battery protection
- Load switch
- Power management

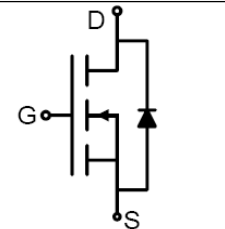

Schematic Diagram

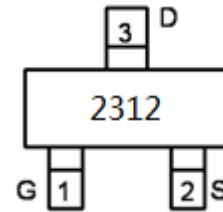

Marking and pin Assignment

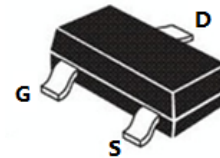

SOT-23 top view

Package Marking and Ordering Information

Device Marking	Device	Device Package	Reel Size	Tape width	Quantity
2312	JY2312	SOT-23	Ø180mm	8mm	3000 units

Table 1. Absolute Maximum Ratings ($T_A=25^\circ C$)

Symbol	Parameter	Value	Unit
V_{DS}	Drain-Source Voltage ($V_{GS}=0V$)	20	V
V_{GS}	Gate-Source Voltage ($V_{DS}=0V$)	± 12	V
I_D	Drain Current-Continuous	6	A
$I_{DM (pluse)}$	Drain Current-Continuous@ Current-Pulsed (Note 1)	16	A
P_D	Maximum Power Dissipation	1.3	W
T_J, T_{STG}	Operating Junction and Storage Temperature Range	-55 To 150	$^\circ C$

Notes 1.Repetitive Rating: Pulse width limited by maximum junction temperature

Table 2. Thermal Characteristic

Symbol	Parameter	Value	Unit
$R_{\theta JA}$	Thermal Resistance, Junction-to-Ambient	96	$^\circ C/W$

Table 3. Electrical Characteristics (T_A=25°C unless otherwise noted)

Symbol	Parameter	Conditions	Min	Typ	Max	Unit
On/Off States						
B _V DSS	Drain-Source Breakdown Voltage	V _{GS} =0V, I _D =250μA	20	22		V
I _{DSS}	Zero Gate Voltage Drain Current	V _{DS} =20V, V _{GS} =0V			1	μA
I _{GSS}	Gate-Body Leakage Current	V _{GS} =±12V, V _{DS} =0V			±100	nA
V _{GS(th)}	Gate Threshold Voltage	V _{DS} =V _{GS} , I _D =250μA	0.5	0.7	1.1	V
g _{FS}	Forward Transconductance	V _{DS} =5V, I _D =5A	4	8		S
R _{DS(ON)}	Drain-Source On-State Resistance	V _{GS} =4.5V, I _D =5A		18	26	mΩ
		V _{GS} =2.5V, I _D =4A		23	34	mΩ
Dynamic Characteristics						
C _{iss}	Input Capacitance	V _{DS} =10V, V _{GS} =0V, f=1.0MHz		500		pF
C _{oss}	Output Capacitance			300		pF
C _{rss}	Reverse Transfer Capacitance			140		pF
Switching Times						
t _{d(on)}	Turn-on Delay Time	V _{DD} =10V, I _D =1A, R _L =2.8Ω V _{GS} =4.5V, R _G =6Ω		20		nS
t _r	Turn-on Rise Time			19		nS
t _{d(off)}	Turn-Off Delay Time			65		nS
t _f	Turn-Off Fall Time			25		nS
Q _g	Total Gate Charge	V _{DS} =10V, I _D =5A, V _{GS} =4.5V		10		nC
Q _{gs}	Gate-Source Charge			2.3		nC
Q _{gd}	Gate-Drain Charge			2.9		nC
Source-Drain Diode Characteristics						
I _{SD}	Source-Drain Current(Body Diode)				5	A
V _{SD}	Forward on Voltage ^(Note 1)	V _{GS} =0V, I _S =5A			1.2	V

Notes 1. Repetitive Rating: Pulse width limited by maximum junction temperature.

Switch Time Test Circuit and Switching Waveforms:

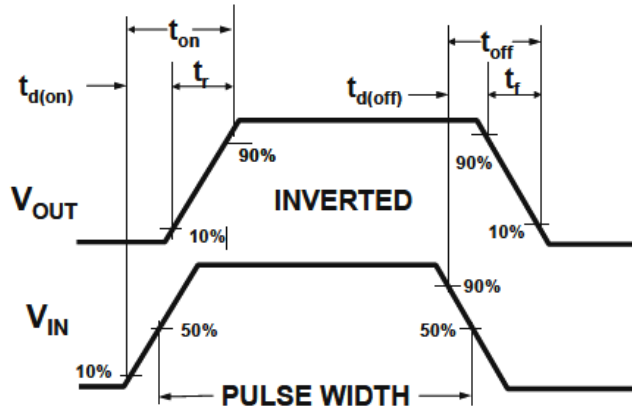
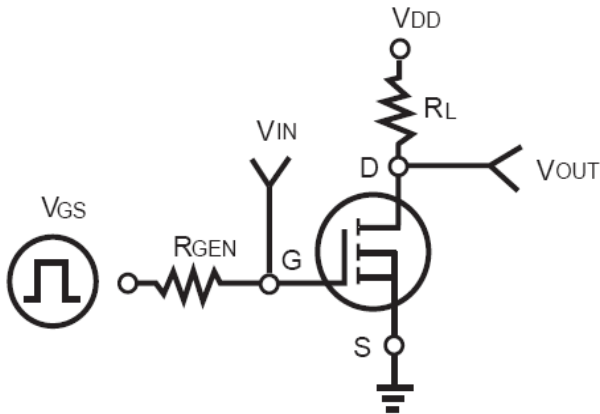

TYPICAL ELECTRICAL AND THERMAL CHARACTERISTICS (Curves)

Figure1. Power Dissipation

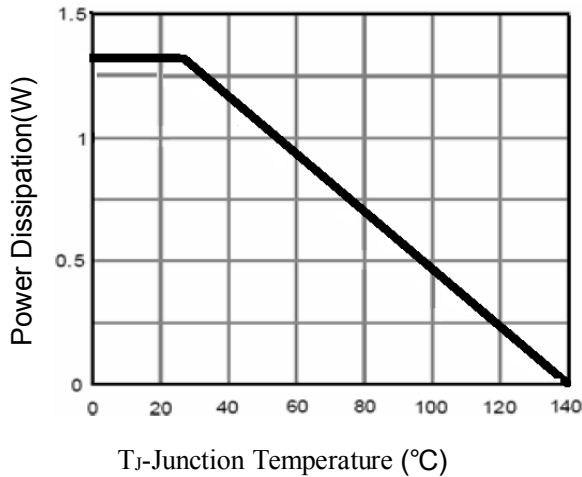

Figure2. Drain Current

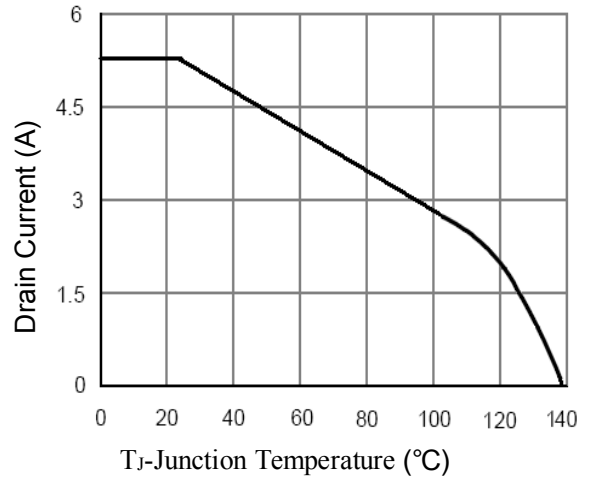

Figure3. Output Characteristics

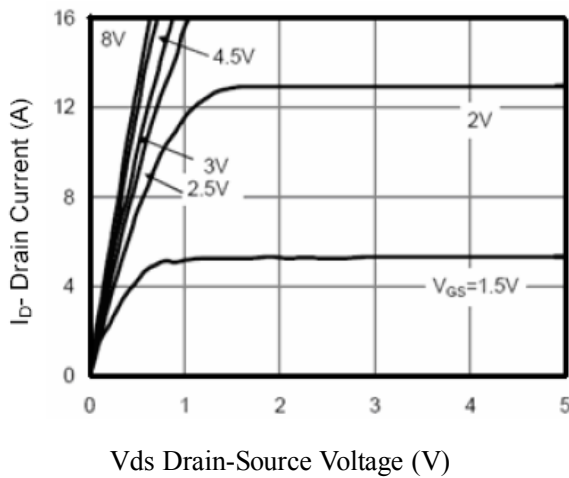

Figure4. Transfer Characteristics

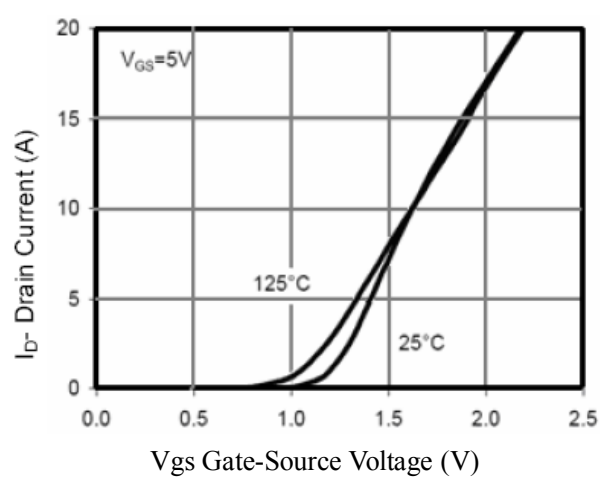

Figure5. Capacitance

Figure6. $R_{DS(ON)}$ vs Junction Temperature

Figure7. Max BV_{DSS} vs Junction Temperature

Figure8. $V_{GS(th)}$ vs Junction Temperature

Figure9. Gate Charge Waveforms

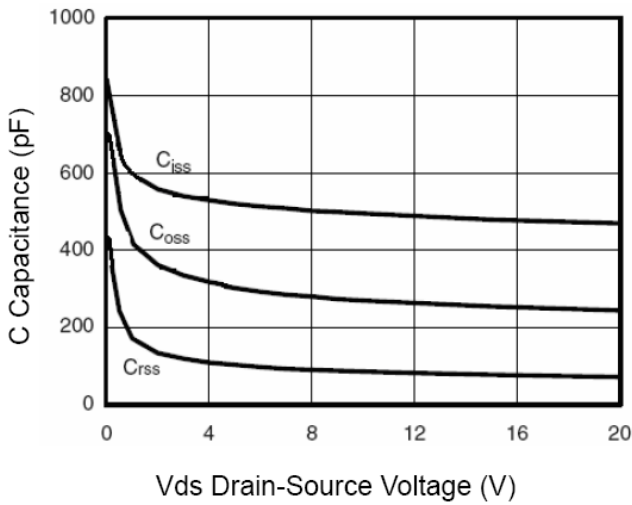
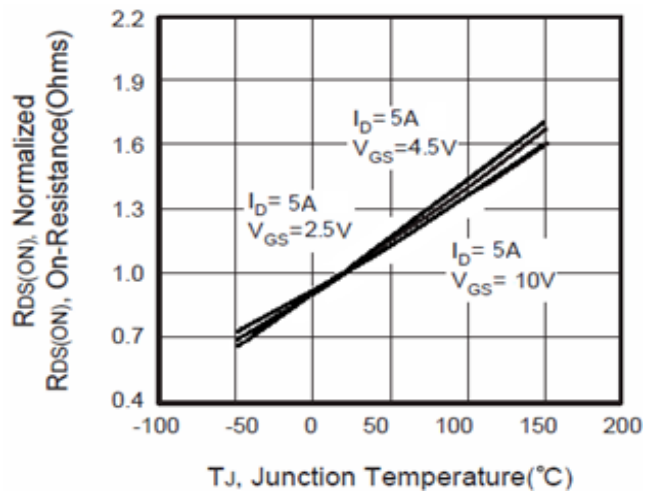
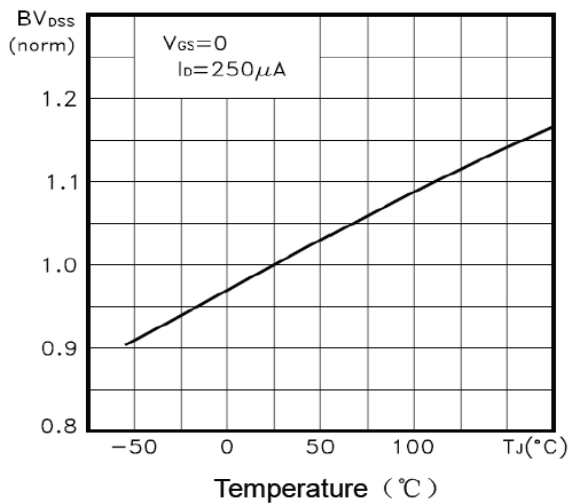
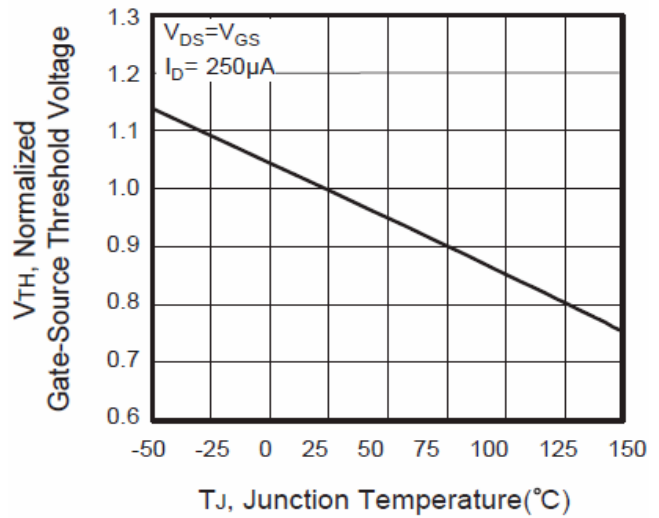
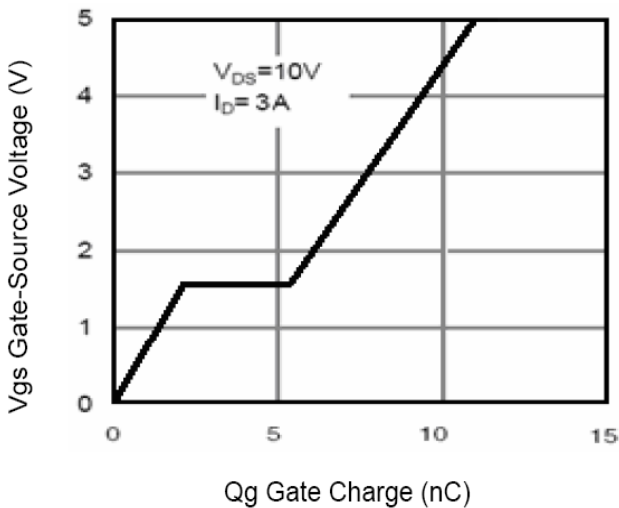
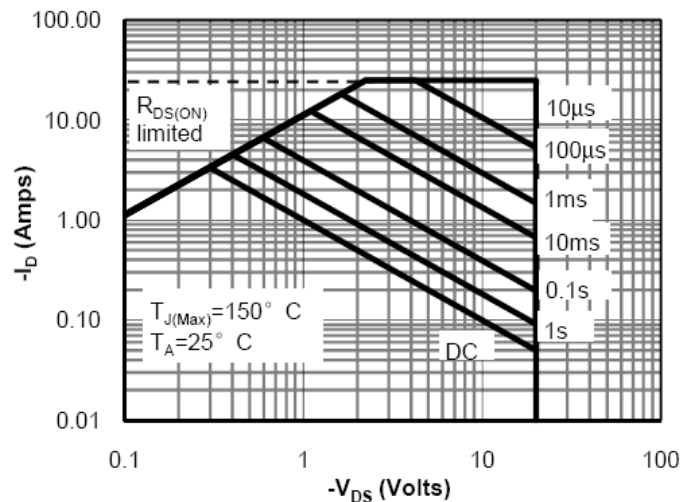
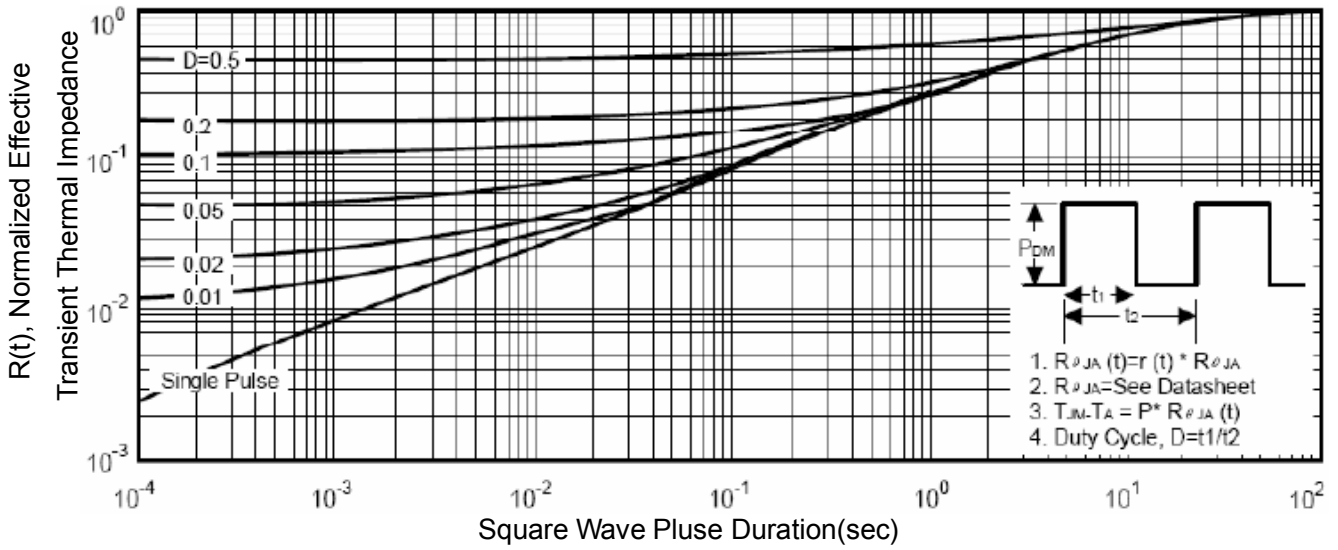
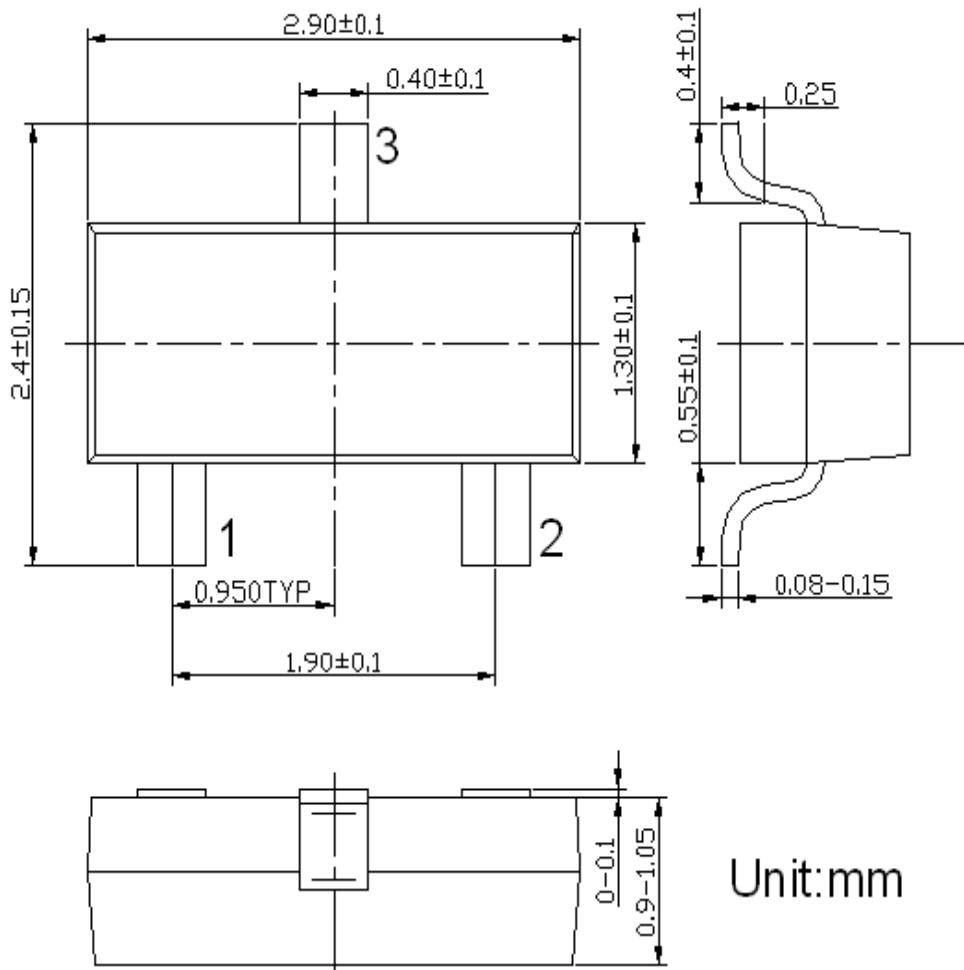
Figure10. Maximum Safe Operating Area

Figure11. Normalized Maximum Transient Thermal Impedance

SOT-23 Package Information



Carrier Dimensions

PKG TYPE	W	P	E	F	D	D1	Po	Po10	P2
SOT-23	8.00	4.00	1.75	3.50	1.50	1.00	4.00	40.00	2.00
Tolerance	+0.3/-0.1	±0.1	±0.1	±0.1	±0.1	±0.1	±0.1	±0.2	±0.05

A0	B0	K0	T
3.15	2.77	1.22	0.20
±0.1	±0.1	±0.1	±0.02

