

Bias Resistor Transistors

PNP Silicon Surface Mount Transistors with Monolithic Bias Resistor Network

This new series of digital transistors is designed to replace a single device and its external resistor bias network. The BRT (Bias Resistor Transistor) contains a single transistor with a monolithic bias network consisting of two resistors; a series base resistor and a base-emitter resistor. The BRT eliminates these individual components by integrating them into a single device. The use of a BRT can reduce both system cost and board space. The device is housed in the SOT-23 package which is designed for low power surface mount applications.

- Simplifies Circuit Design
- Reduces Board Space
- Reduces Component Count
- The SOT-23 package can be soldered using wave or reflow. The modified gull-winged leads absorb thermal stress during soldering eliminating the possibility of damage to the die.
- Available in 8 mm embossed tape and reel. Use the Device Number to order the 7 inch/3000 unit reel. Replace “T1” with “T3” in the Device Number to order the 13 inch/10,000 unit reel.
- We declare that the material of product compliance with RoHS requirements and Halogen Free.
- S- Prefix for Automotive and Other Applications Requiring Unique Site and Control Change Requirements; AEC-Q101 Qualified and PPAP Capable.

S-LMUN2110LT1G Series

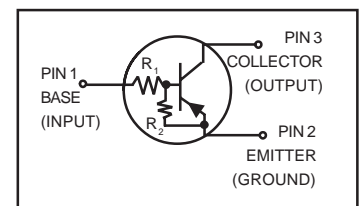
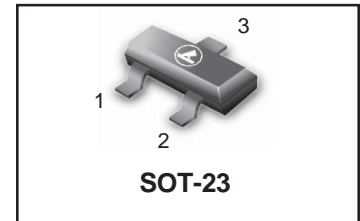

MAXIMUM RATINGS ($T_A = 25^\circ\text{C}$ unless otherwise noted)

Rating	Symbol	Value	Unit
Collector-Base Voltage	V_{CBO}	-50	V
Collector-Emitter Voltage	V_{CEO}	-50	V
Collector Current	I_C	-100	mA

THERMAL CHARACTERISTICS

Characteristic	Symbol	Max	Unit
Total Device Dissipation $T_A = 25^\circ\text{C}$ Derate above 25°C	P_D	246 (Note 1.) 400 (Note 2.) 1.5 (Note 1.) 2.0 (Note 2.)	mW $^\circ\text{C}/\text{W}$
Thermal Resistance – Junction-to-Ambient	$R_{\theta JA}$	508 (Note 1.) 311 (Note 2.)	$^\circ\text{C}/\text{W}$
Thermal Resistance – Junction-to-Lead	$R_{\theta JL}$	174 (Note 1.) 208 (Note 2.)	$^\circ\text{C}/\text{W}$
Junction and Storage Temperature Range	T_J, T_{stg}	-55 to +150	$^\circ\text{C}$

1. FR-4 @ Minimum Pad
2. FR-4 @ 1.0 x 1.0 inch Pad

S-LMUN2110LT1G Series

DEVICE MARKING AND RESISTOR VALUES

Device	Package	Marking	R1 (K)	R2 (K)	Shipping
S-LMUN2110LT1G (Note 3.) S-LMUN2110LT3G	SOT-23	A6O	47	∞	3000/Tape & Reel 10,000/Tape & Reel
S-LMUN2111LT1G S-LMUN2111LT3G	SOT-23	A6A	10	10	3000/Tape & Reel 10,000/Tape & Reel
S-LMUN2112LT1G S-LMUN2112LT3G	SOT-23	A6B	22	22	3000/Tape & Reel 10,000/Tape & Reel
S-LMUN2113LT1G S-LMUN2113LT3G	SOT-23	A6C	47	47	3000/Tape & Reel 10,000/Tape & Reel
S-LMUN2114LT1G S-LMUN2114LT3G	SOT-23	A6D	10	47	3000/Tape & Reel 10,000/Tape & Reel
S-LMUN2115LT1G S-LMUN2115LT3G	SOT-23	A6E	10	∞	3000/Tape & Reel 10,000/Tape & Reel
S-LMUN2116LT1G S-LMUN2116LT3G	SOT-23	A6F	4.7	∞	3000/Tape & Reel 10,000/Tape & Reel
S-LMUN2130LT1G (Note 3.) S-LMUN2130LT3G	SOT-23	A6G	1.0	1.0	3000/Tape & Reel 10,000/Tape & Reel
S-LMUN2131LT1G S-LMUN2131LT3G	SOT-23	A6H	2.2	2.2	3000/Tape & Reel 10,000/Tape & Reel
S-LMUN2132LT1G S-LMUN2132LT3G	SOT-23	A6J	4.7	4.7	3000/Tape & Reel 10,000/Tape & Reel
S-LMUN2133LT1G S-LMUN2133LT3G	SOT-23	A6K	4.7	47	3000/Tape & Reel 10,000/Tape & Reel
S-LMUN2134LT1G (Note 3.) S-LMUN2134LT3G	SOT-23	A6L	22	47	3000/Tape & Reel 10,000/Tape & Reel
S-LMUN2136LT1G S-LMUN2136LT3G	SOT-23	A6N	100	100	3000/Tape & Reel 10,000/Tape & Reel
S-LMUN2137LT1G S-LMUN2137LT3G	SOT-23	A6P	47	22	3000/Tape & Reel 10,000/Tape & Reel
S-LMUN2138LT1G (Note 3.) S-LMUN2138LT3G	SOT-23	A6R	2.2	∞	3000/Tape & Reel 10,000/Tape & Reel
S-LMUN2140LT1G (Note 3.) S-LMUN2140LT3G	SOT-23	A6T	47	∞	3000/Tape & Reel 10,000/Tape & Reel

3. New devices. Updated curves to follow in subsequent data sheets.

S-LMUN2110LT1G Series

ELECTRICAL CHARACTERISTICS ($T_A = 25^\circ\text{C}$ unless otherwise noted)

Characteristic	Symbol	Min	Typ	Max	Unit
OFF CHARACTERISTICS					
Collector-Base Cutoff Current ($V_{CB} = -50\text{ V}, I_E = 0$)	I_{CBO}	-	-	-100	nA
Collector-Emitter Cutoff Current ($V_{CE} = -50\text{ V}, I_B = 0$)	I_{CEO}	-	-	-500	nA
Emitter-Base Cutoff Current ($V_{EB} = -6.0\text{ V}, I_C = 0$)	I_{EBO}	-	-	-0.1	mA
S-LMUN2110LT1G		-	-	-0.5	
S-LMUN2111LT1G		-	-	-0.2	
S-LMUN2112LT1G		-	-	-0.1	
S-LMUN2113LT1G		-	-	-0.2	
S-LMUN2114LT1G		-	-	-0.9	
S-LMUN2115LT1G		-	-	-1.9	
S-LMUN2116LT1G		-	-	-4.3	
S-LMUN2130LT1G		-	-	-2.3	
S-LMUN2131LT1G		-	-	-1.5	
S-LMUN2132LT1G		-	-	-0.18	
S-LMUN2133LT1G		-	-	-0.13	
S-LMUN2134LT1G		-	-	-0.05	
S-LMUN2136LT1G		-	-	-0.13	
S-LMUN2137LT1G		-	-	-4.0	
S-LMUN2138LT1G		-	-	-0.2	
S-LMUN2140LT1G		-	-	-	
Collector-Base Breakdown Voltage ($I_C = -10\mu\text{A}, I_E = 0$)	$V_{(BR)CBO}$	-50	-	-	V
Collector-Emitter Breakdown Voltage (Note 4.) ($I_C = -2.0\text{ mA}, I_B = 0$)	$V_{(BR)CEO}$	-50	-	-	V

4. Pulse Test: Pulse Width < 300 μs , Duty Cycle < 2.0%

ELECTRICAL CHARACTERISTICS ($T_A = 25^\circ\text{C}$ unless otherwise noted) (Continued)

Characteristic	Symbol	Min	Typ	Max	Unit
ON CHARACTERISTICS (Note 5.)					
DC Current Gain ($V_{CE} = -10\text{ V}, I_C = -5.0\text{ mA}$)	h_{FE}	80	140	-	
S-LMUN2110LT1G		35	60	-	
S-LMUN2111LT1G		60	100	-	
S-LMUN2112LT1G		80	140	-	
S-LMUN2113LT1G		80	140	-	
S-LMUN2114LT1G		160	250	-	
S-LMUN2115LT1G		160	250	-	
S-LMUN2130LT1G		3.0	5.0	-	
S-LMUN2131LT1G		8.0	15	-	
S-LMUN2132LT1G		15	27	-	
S-LMUN2133LT1G		80	140	-	
S-LMUN2134LT1G		80	130	-	
S-LMUN2136LT1G		80	150	-	
S-LMUN2137LT1G		80	140	-	
S-LMUN2138LT1G		160	350	-	
S-LMUN2140LT1G		120	250	-	
Collector-Emitter Saturation Voltage ($I_C = -10\text{ mA}, I_B = -0.3\text{ mA}$) ($I_C = -10\text{ mA}, I_B = -5\text{ mA}$)S-LMUN2130LT1G/S-LMUN2131LT1G ($I_C = -10\text{ mA}, I_B = -1\text{ mA}$)S-LMUN2115LT1G/S-LMUN2116LT1G/ S-LMUN2132LT1G/S-LMUN2133LT1G/ S-LMUN2134LT1G/S-LMUN2138LT1G/S-LMUN2140LT1G	$V_{CE(sat)}$	-	-	-0.25	V

S-LMUN2110LT1G Series

ELECTRICAL CHARACTERISTICS ($T_A = 25^\circ\text{C}$ unless otherwise noted) (Continued)

Characteristic	Symbol	Min	Typ	Max	Unit
ON CHARACTERISTICS (Note 5.)					
Output Voltage (on) ($V_{CC} = -5.0\text{ V}$, $V_B = -2.5\text{ V}$, $R_L = 1.0\text{ k}\Omega$)	V_{OL}	-	-	-0.2	V
S-LMUN2110LT1G		-	-	-0.2	
S-LMUN2114LT1G		-	-	-0.2	
S-LMUN2111LT1G		-	-	-0.2	
S-LMUN2112LT1G		-	-	-0.2	
S-LMUN2114LT1G		-	-	-0.2	
S-LMUN2115LT1G		-	-	-0.2	
S-LMUN2116LT1G		-	-	-0.2	
S-LMUN2130LT1G		-	-	-0.2	
S-LMUN2131LT1G		-	-	-0.2	
S-LMUN2132LT1G		-	-	-0.2	
S-LMUN2133LT1G		-	-	-0.2	
S-LMUN2134LT1G		-	-	-0.2	
S-LMUN2138LT1G		-	-	-0.2	
($V_{CC} = -5.0\text{ V}$, $V_B = -3.5\text{ V}$, $R_L = 1.0\text{ k}\Omega$)		-	-	-0.2	
S-LMUN2113LT1G		-	-	-0.2	
S-LMUN2140LT1G		-	-	-0.2	
($V_{CC} = -5.0\text{ V}$, $V_B = -5.5\text{ V}$, $R_L = 1.0\text{ k}\Omega$)		-	-	-0.2	
S-LMUN2136LT1G		-	-	-0.2	
($V_{CC} = -5.0\text{ V}$, $V_B = -4.0\text{ V}$, $R_L = 1.0\text{ k}\Omega$)		-	-	-0.2	
S-LMUN2137LT1G		-	-	-0.2	
Output Voltage (off) ($V_{CC} = -5.0\text{ V}$, $V_B = 0.5\text{ V}$, $R_L = 1.0\text{ k}\Omega$) ($V_{CC} = -5.0\text{ V}$, $V_B = 0.25\text{ V}$, $R_L = 1.0\text{ k}\Omega$)	V_{OH}	-4.9	-	-	V
S-LMUN2115LT1G					
S-LMUN2116LT1G					
S-LMUN2131LT1G					
S-LMUN2132LT1G					
S-LMUN2138LT1G					
S-LMUN2140LT1G					
($V_{CC} = -5.0\text{ V}$, $V_B = 0.050\text{ V}$, $R_L = 1.0\text{ k}\Omega$)					
S-LMUN2130LT1G					
Input Resistor	R_1	32.9	47	61.1	k Ω
S-LMUN2110LT1G		7.0	10	13	
S-LMUN2111LT1G		15.4	22	28.6	
S-LMUN2112LT1G		32.9	47	61.1	
S-LMUN2113LT1G		7.0	10	13	
S-LMUN2114LT1G		7.0	10	13	
S-LMUN2115LT1G		3.3	4.7	6.1	
S-LMUN2116LT1G		0.7	1.0	1.3	
S-LMUN2130LT1G		1.5	2.2	2.9	
S-LMUN2131LT1G		3.3	4.7	6.1	
S-LMUN2132LT1G		3.3	4.7	6.1	
S-LMUN2133LT1G		15.4	22	28.6	
S-LMUN2134LT1G		70	100	130	
S-LMUN2136LT1G		32.9	47	61.1	
S-LMUN2137LT1G		1.54	2.2	2.86	
S-LMUN2138LT1G		32.9	47	61.1	
S-LMUN2140LT1G					
Resistor Ratio	R_1/R_2	0.8	1.0	1.2	
S-LMUN2111LT1G/S-LMUN2112LT1G/ S-LMUN2113LT1G/S-LMUN2136LT1G/ S-LMUN2130LT1G/S-LMUN2131LT1G/ S-LMUN2132LT1G S-LMUN2114LT1G		0.17	0.21	0.25	
S-LMUN2115LT1G/S-LMUN2116LT1G/ S-LMUN2110LT1G/S-LMUN2138LT1G/S-LMUN2140LT1G		-	-	-	
S-LMUN2133LT1G		0.055	0.1	0.185	
S-LMUN2134LT1G		0.38	0.47	0.56	
S-LMUN2137LT1G		1.7	2.1	2.6	

5. Pulse Test: Pulse Width < 300 μs , Duty Cycle < 2.0%

S-LMUN2110LT1G Series

TYPICAL ELECTRICAL CHARACTERISTICS
S-LMUN2111LT1G

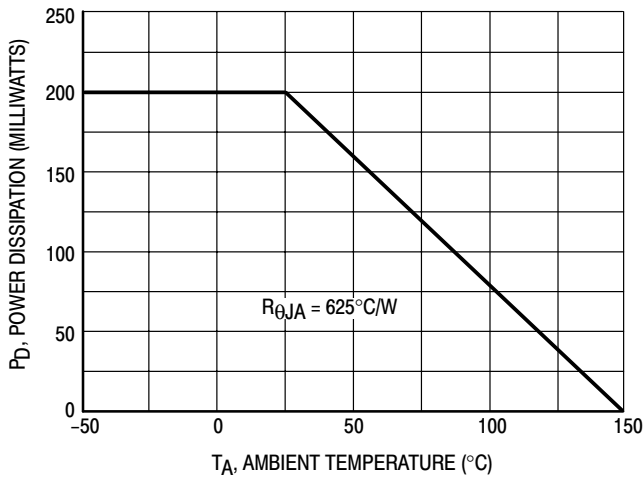

Figure 1. Derating Curve

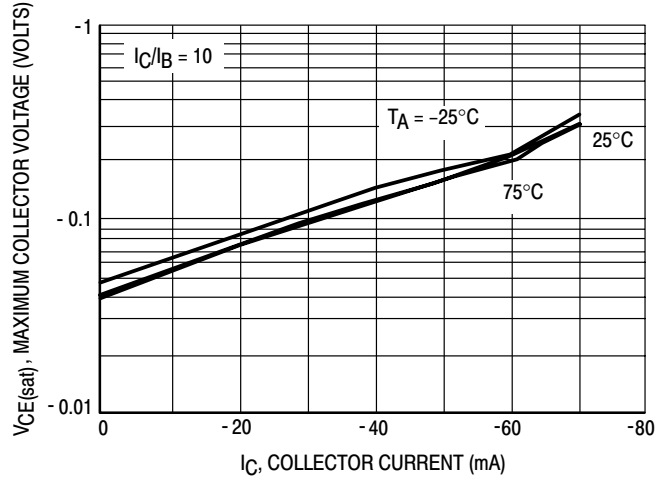

Figure 2. $V_{CE(sat)}$ versus I_C

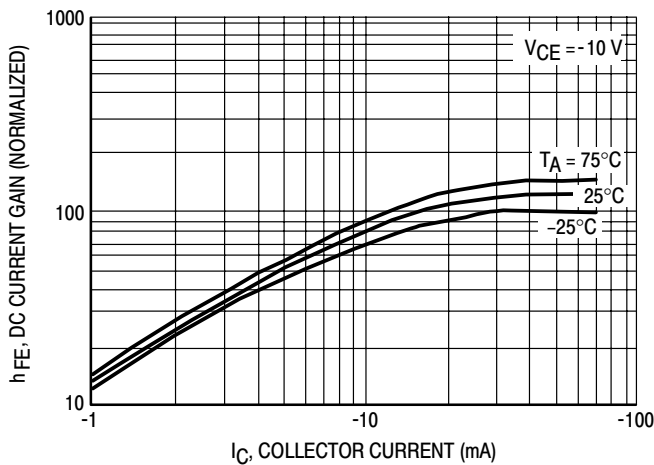

Figure 3. DC Current Gain

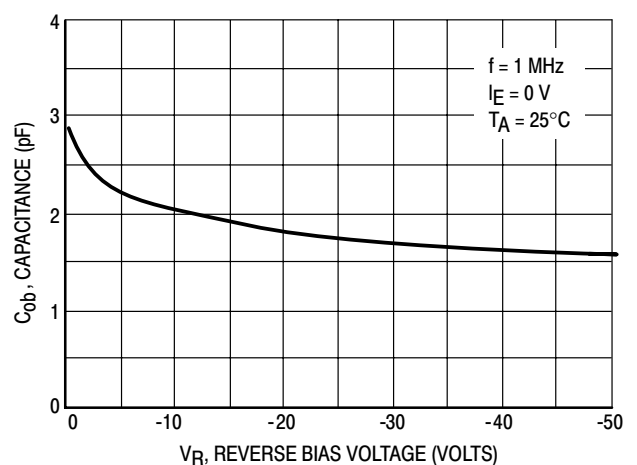

Figure 4. Output Capacitance

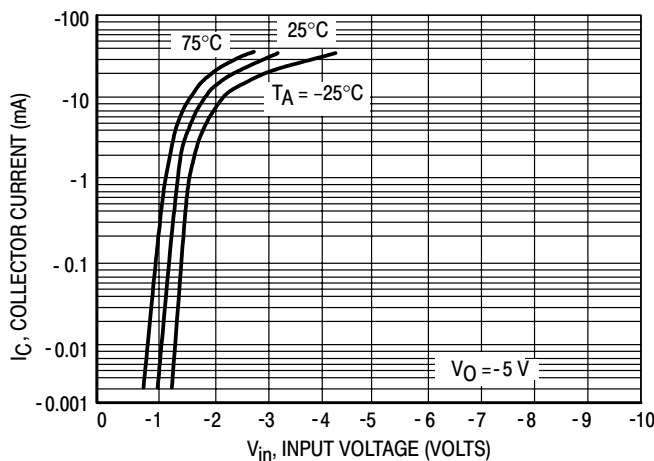

Figure 5. Output Current versus Input Voltage

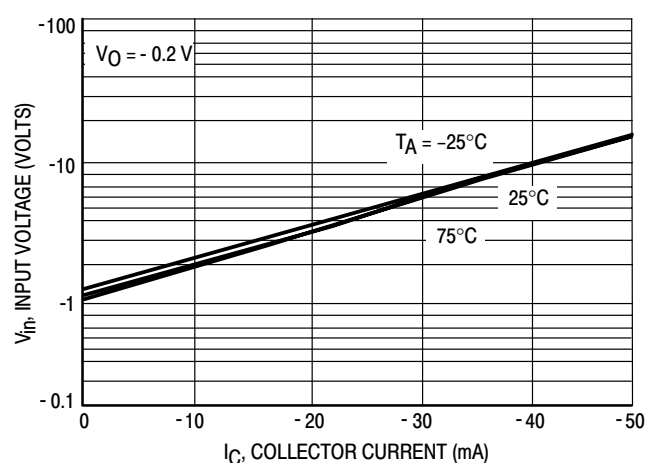

Figure 6. Input Voltage versus Output Current

S-LMUN2110LT1G Series

TYPICAL ELECTRICAL CHARACTERISTICS
S-LMUN2112LT1G

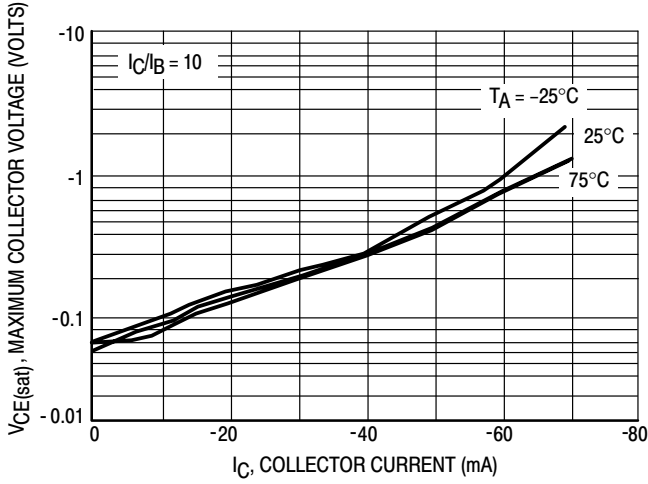

Figure 7. $V_{CE(sat)}$ versus I_C

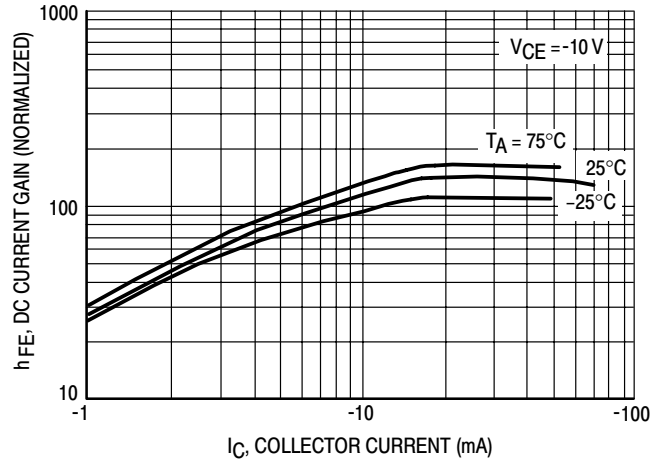

Figure 8. DC Current Gain

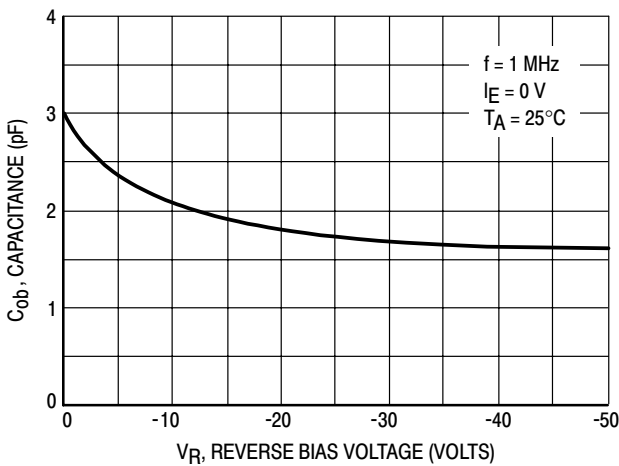

Figure 9. Output Capacitance

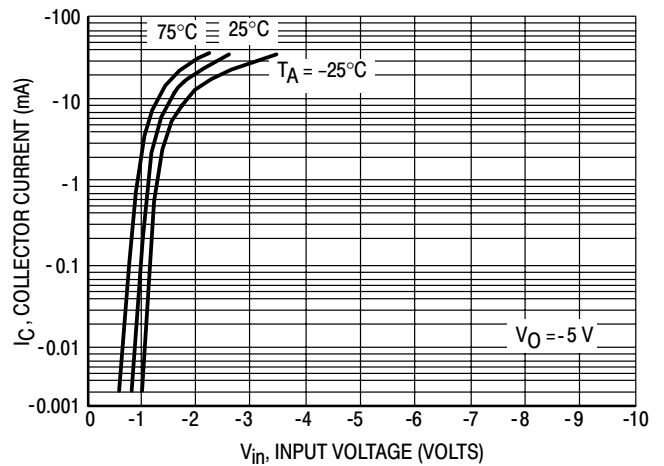

Figure 10. Output Current versus Input Voltage

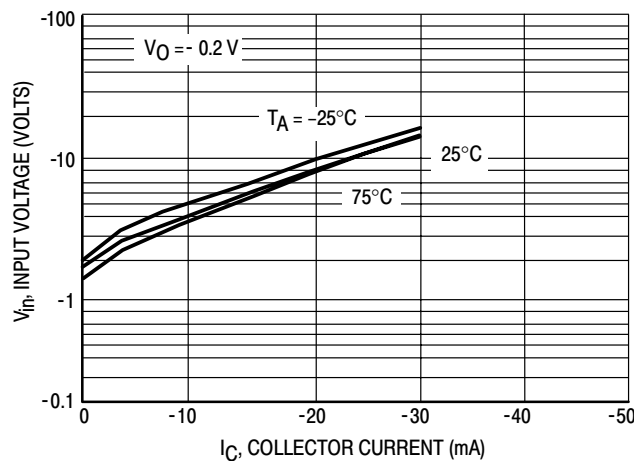

Figure 11. Input Voltage versus Output Current

S-LMUN2110LT1G Series

TYPICAL ELECTRICAL CHARACTERISTICS
S-LMUN2113LT1G

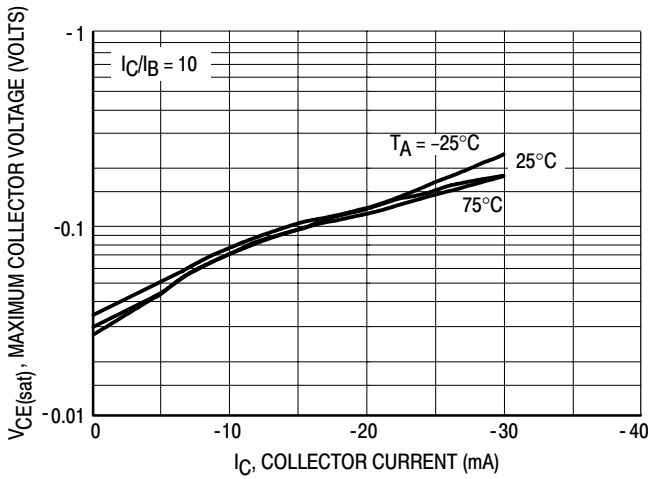

Figure 12. $V_{CE(sat)}$ versus I_C

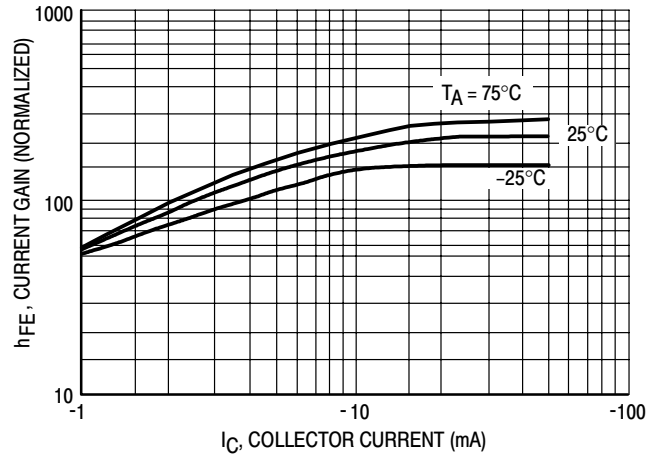

Figure 13. DC Current Gain

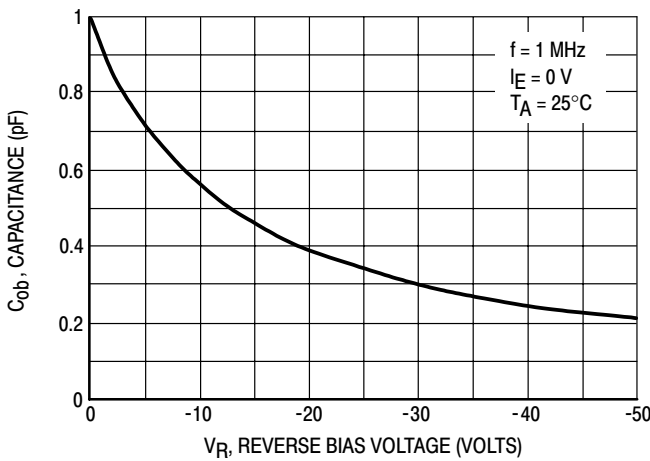

Figure 14. Output Capacitance

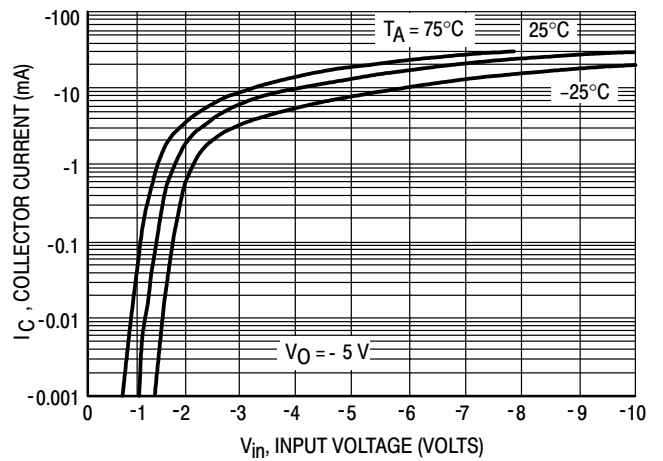

Figure 15. Output Current versus Input Voltage

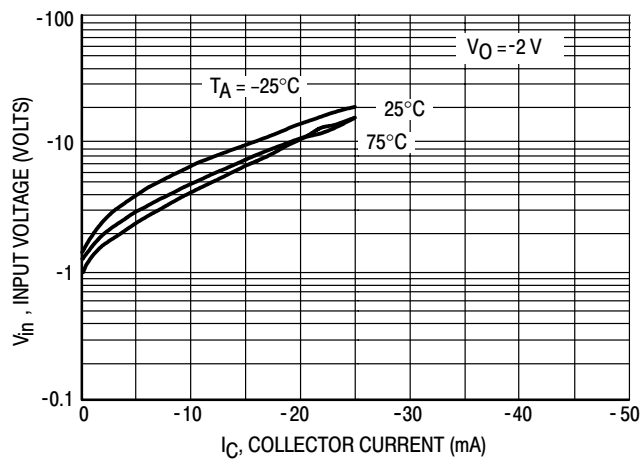

Figure 16. Input Voltage versus Output Current

S-LMUN2110LT1G Series

TYPICAL ELECTRICAL CHARACTERISTICS
S-LMUN2114LT1G

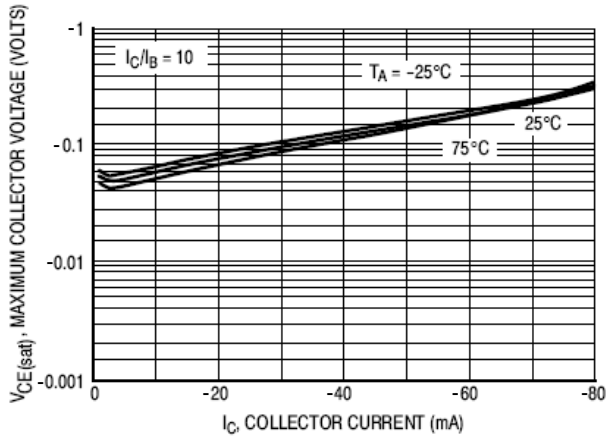

Figure 17. $V_{CE(sat)}$ versus I_C

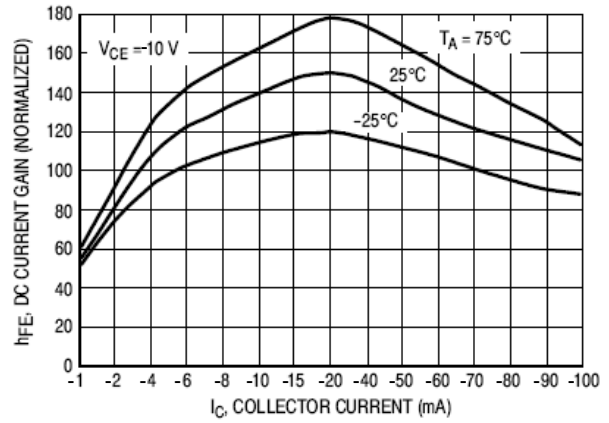

Figure 18. DC Current Gain

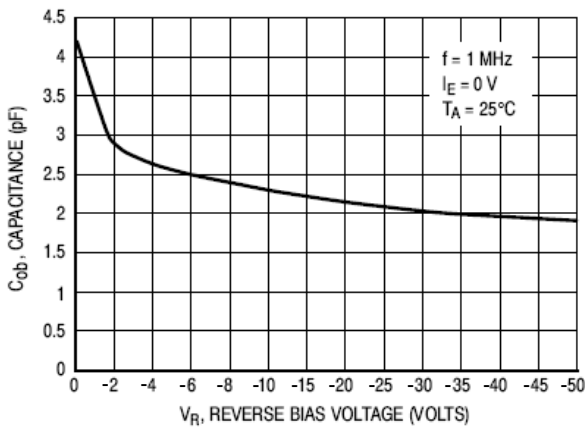

Figure 19. Output Capacitance

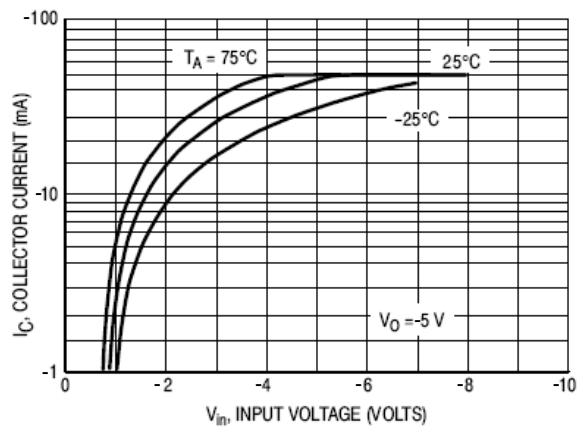

Figure 20. Output Current versus Input Voltage

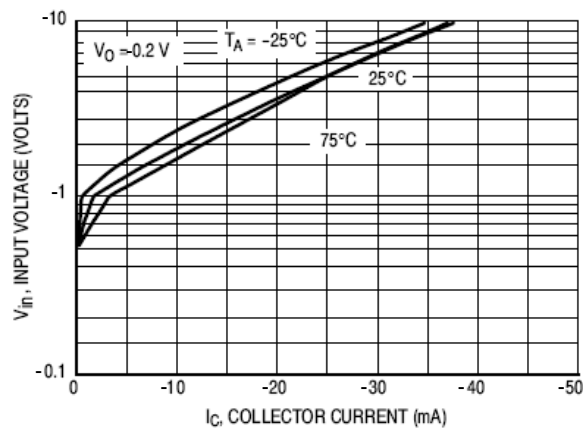

Figure 21. Input Voltage versus Output Current

S-LMUN2110LT1G Series

TYPICAL ELECTRICAL CHARACTERISTICS
S-LMUN2115LT1G

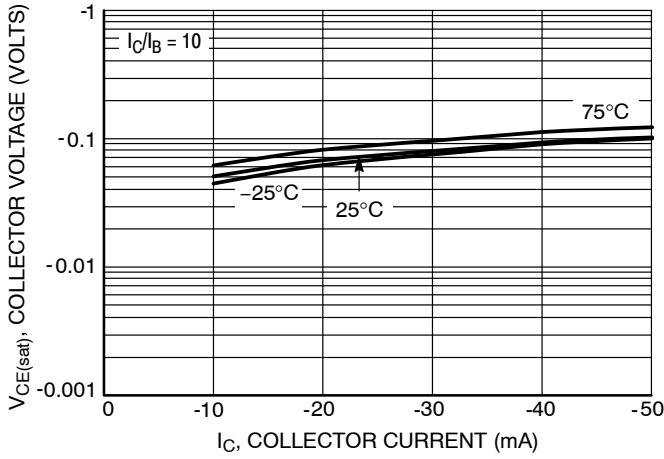

Figure 22. $V_{CE(sat)}$ versus I_C

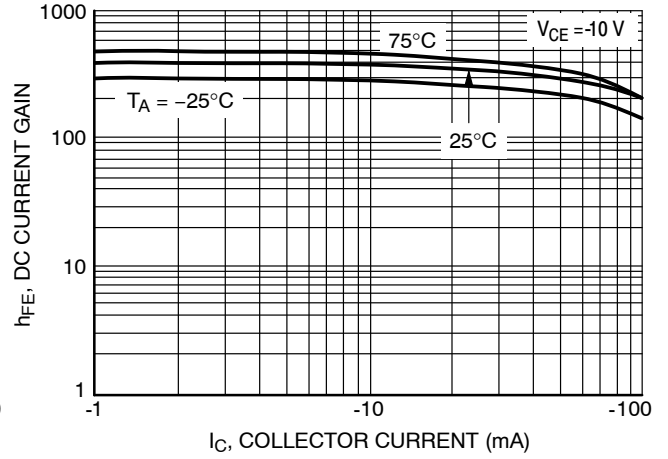

Figure 23. DC Current Gain

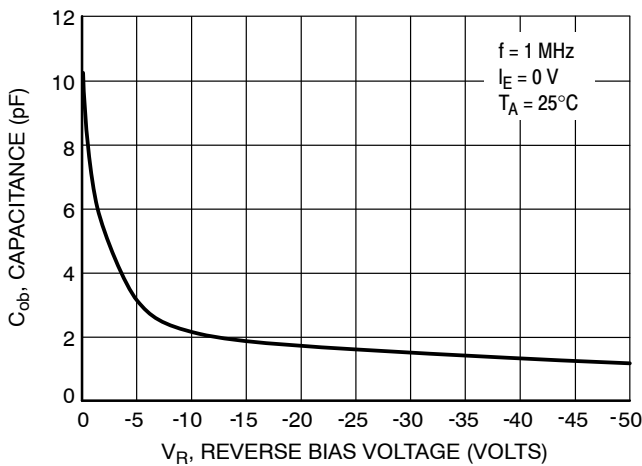

Figure 24. Output Capacitance

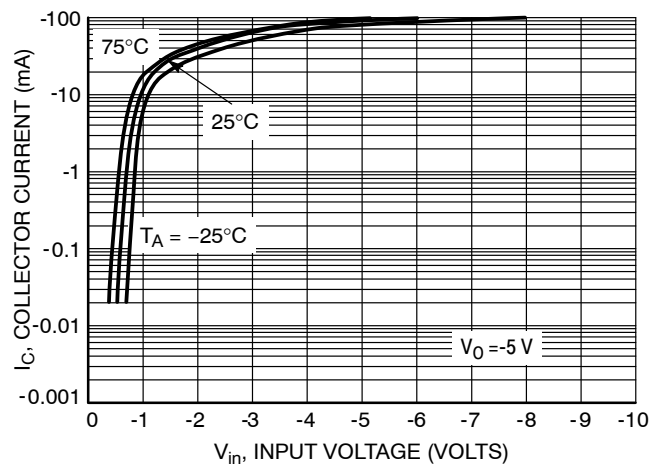

Figure 25. Output Current versus Input Voltage

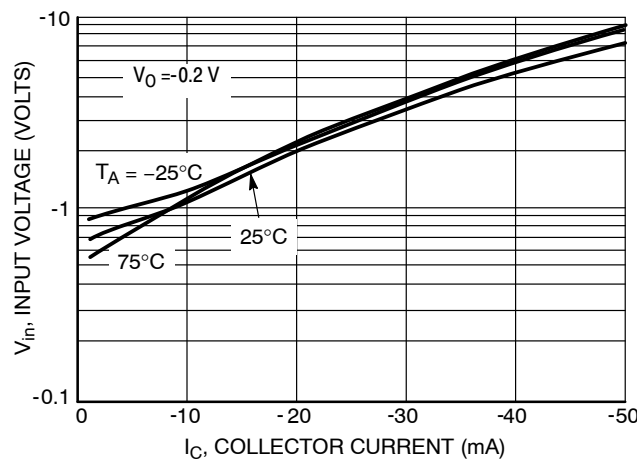

Figure 26. Input Voltage versus Output Current

TYPICAL ELECTRICAL CHARACTERISTICS
S-LMUN2116LT1G

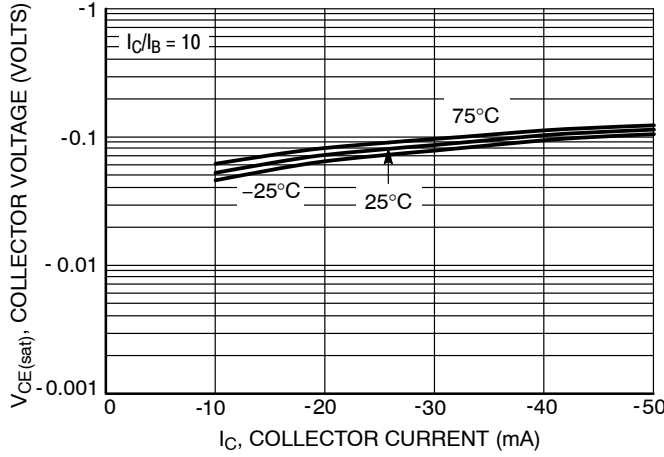

Figure 27. $V_{CE(sat)}$ versus I_C

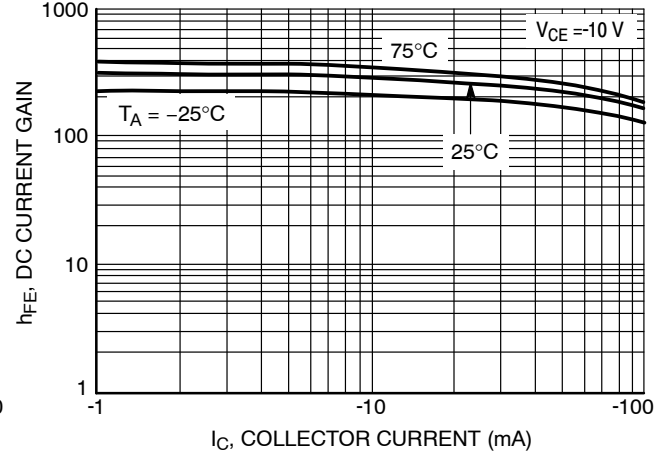

Figure 28. DC Current Gain

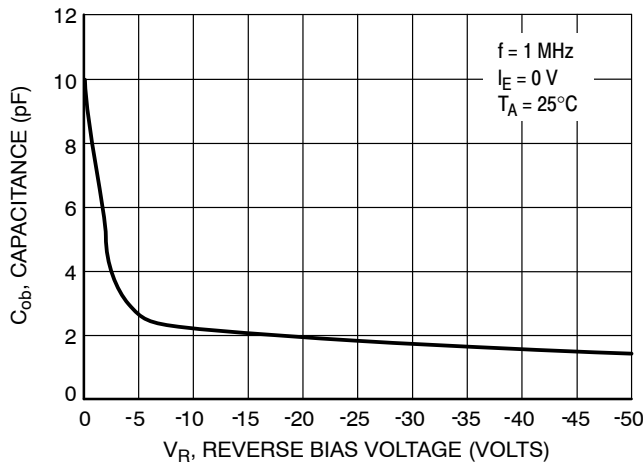

Figure 29. Output Capacitance

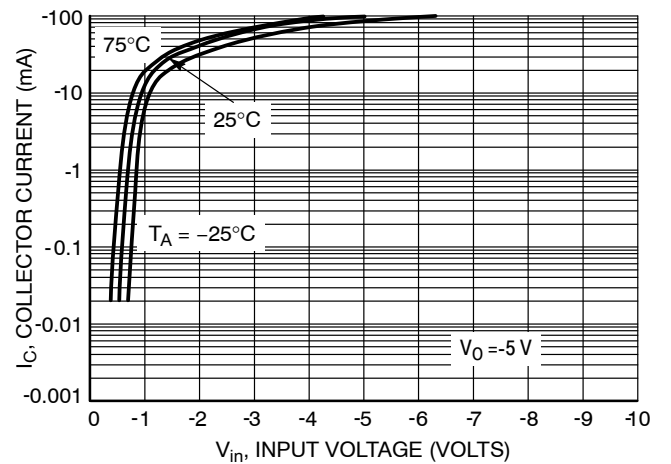

Figure 30. Output Current versus Input Voltage

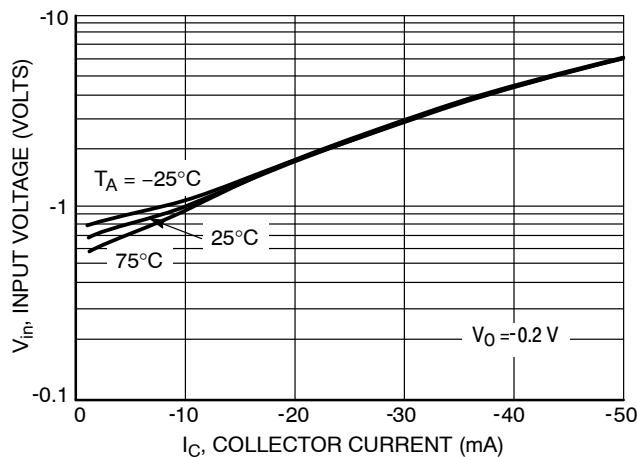

Figure 31. Input Voltage versus Output Current

S-LMUN2110LT1G Series

TYPICAL ELECTRICAL CHARACTERISTICS
S-LMUN2131LT1G

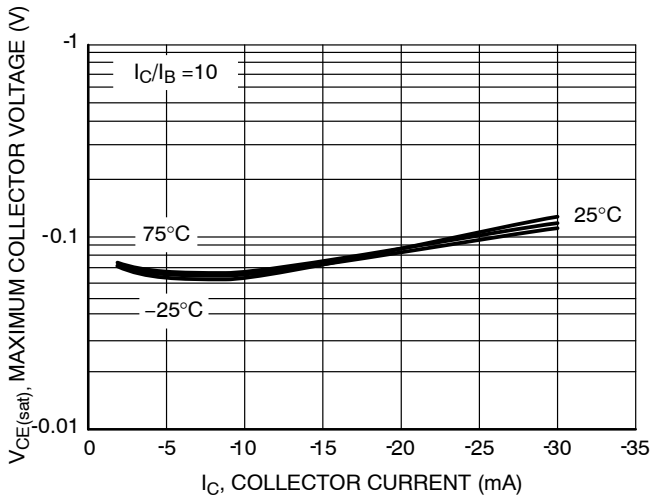

Figure 32. $V_{CE(sat)}$ vs. I_C

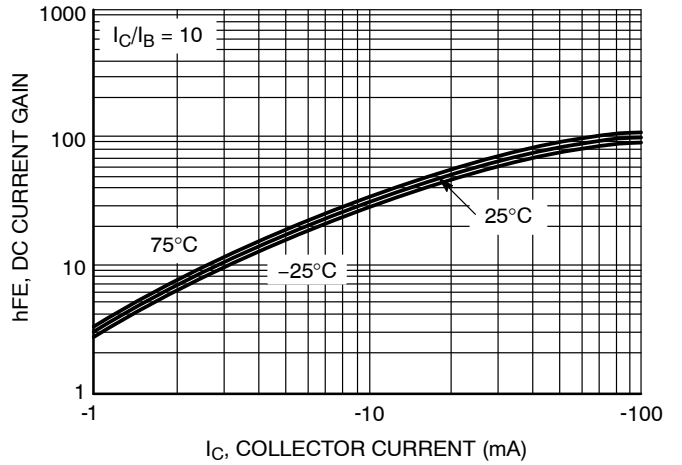

Figure 33. DC Current Gain

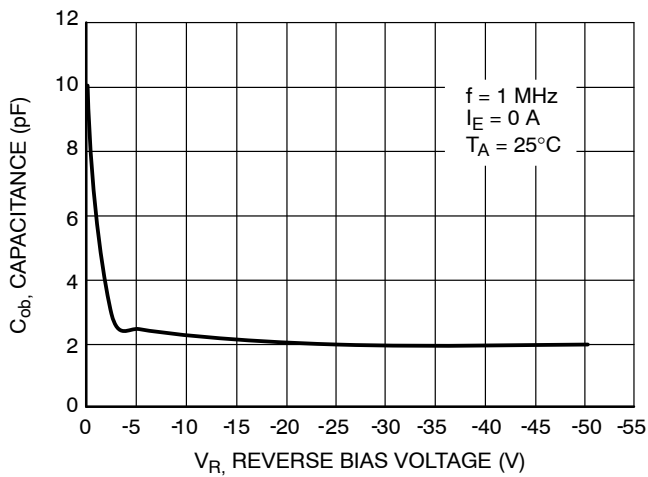

Figure 34. Output Capacitance

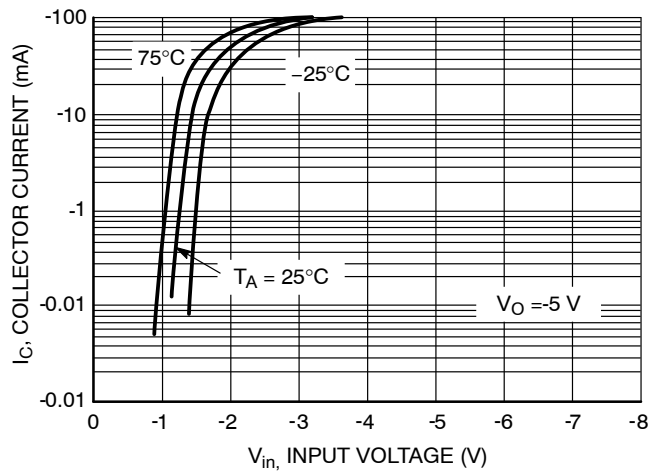

Figure 35. Output Current vs. Input Voltage

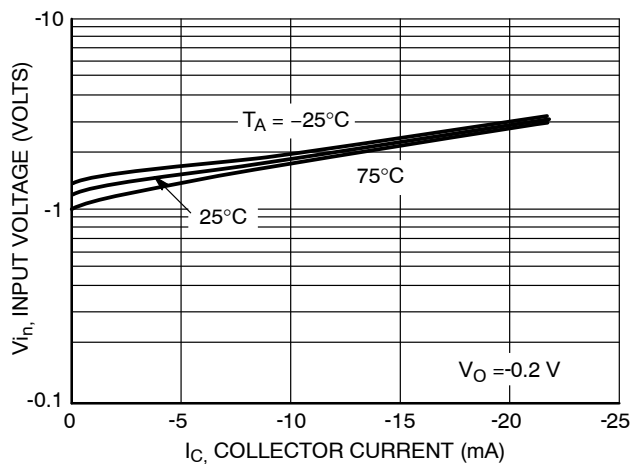

Figure 36. Input Voltage vs. Output Current

TYPICAL ELECTRICAL CHARACTERISTICS
S-LMUN2132LT1G

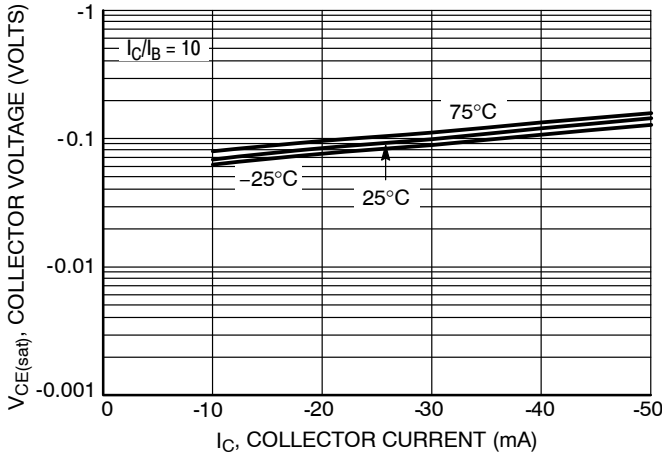

Figure 37. $V_{CE(sat)}$ versus I_C

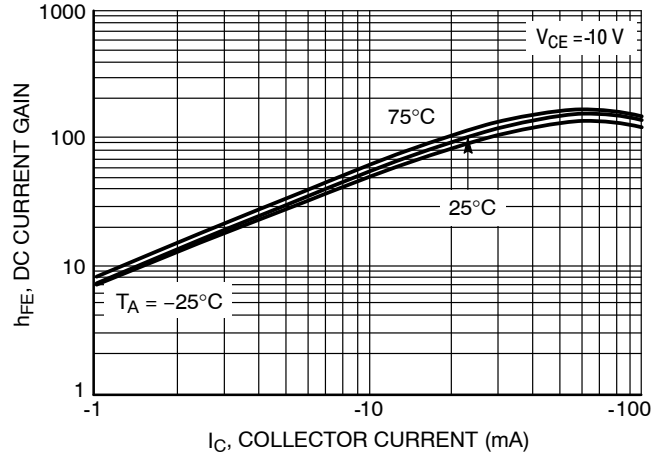

Figure 38. DC Current Gain

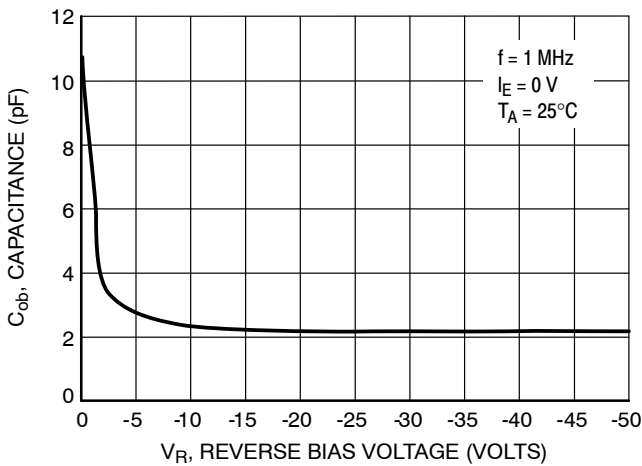

Figure 39. Output Capacitance

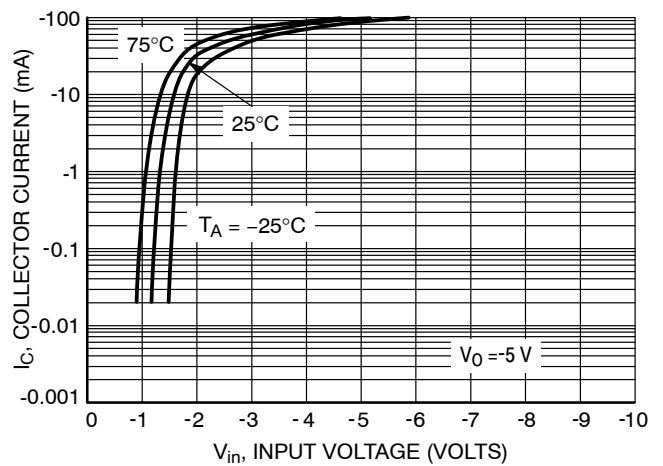

Figure 40. Output Current versus Input Voltage

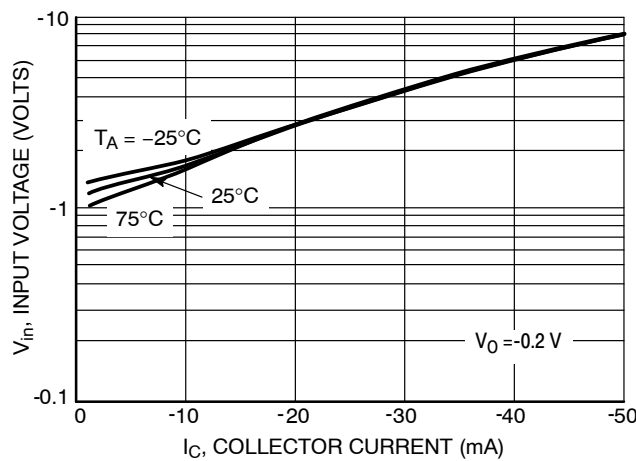

Figure 41. Input Voltage versus Output Current

TYPICAL ELECTRICAL CHARACTERISTICS
S-LMUN2133LT1G

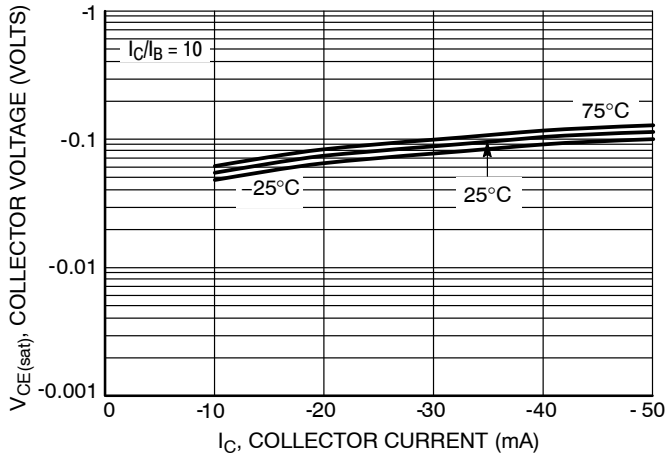

Figure 42. $V_{CE(sat)}$ versus I_C

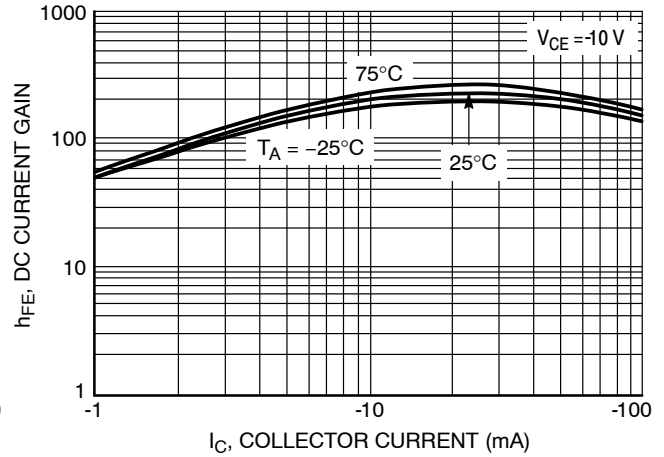

Figure 43. DC Current Gain

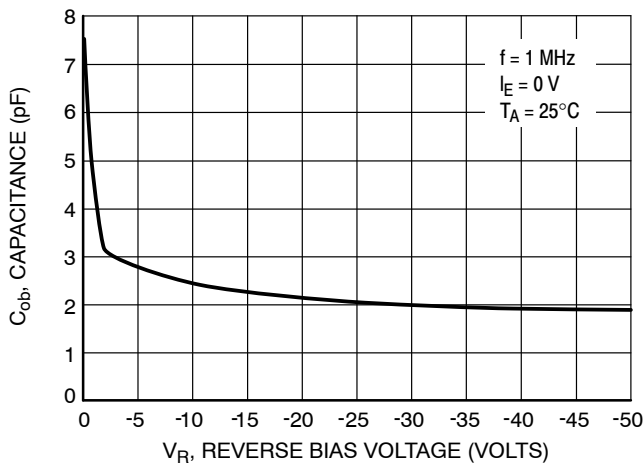

Figure 44. Output Capacitance

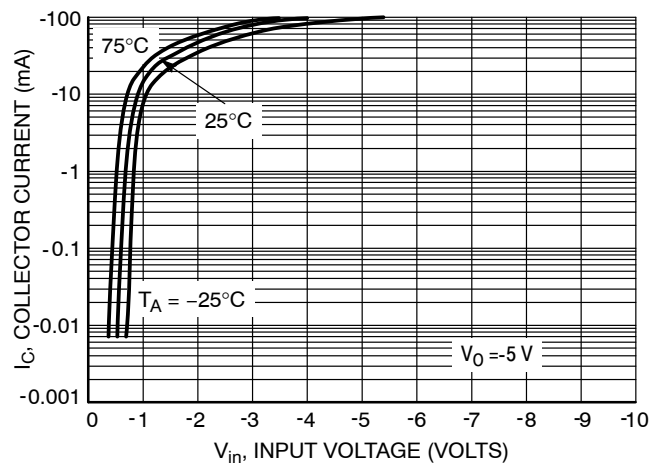

Figure 45. Output Current versus Input Voltage

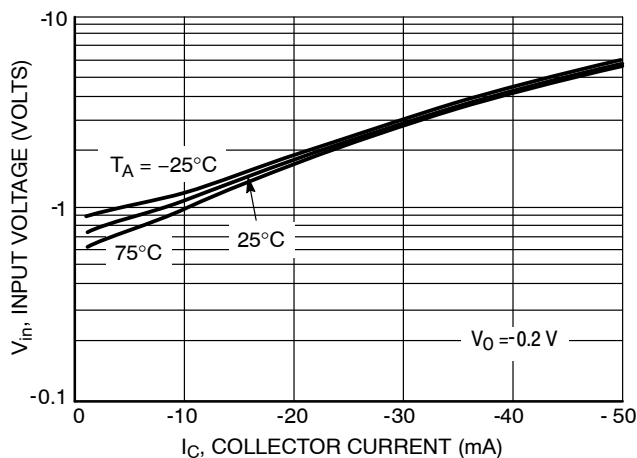

Figure 46. Input Voltage versus Output Current

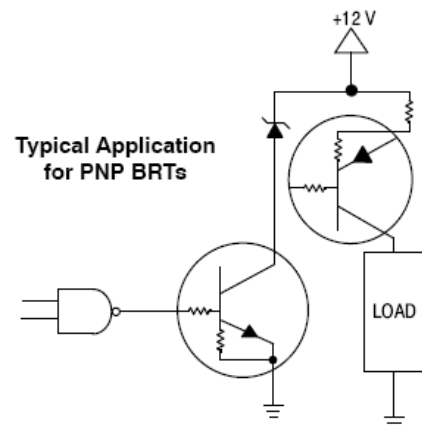

Figure 47. Inexpensive, Unregulated Current Source

S-LMUN2110LT1G Series

TYPICAL ELECTRICAL CHARACTERISTICS
S-LMUN2136LT1G

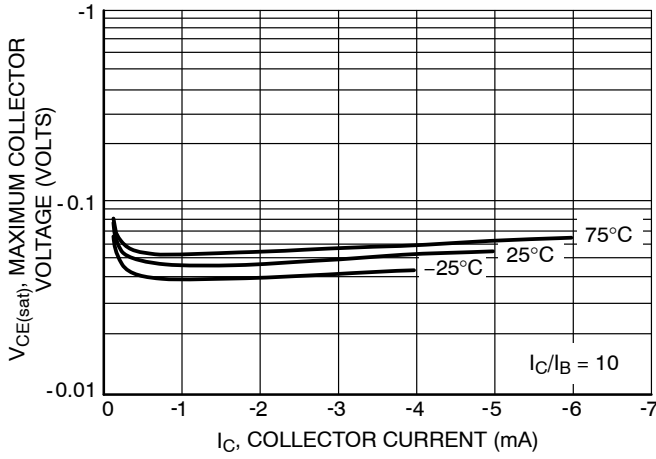

Figure 48. Maximum Collector Voltage vs. Collector Current

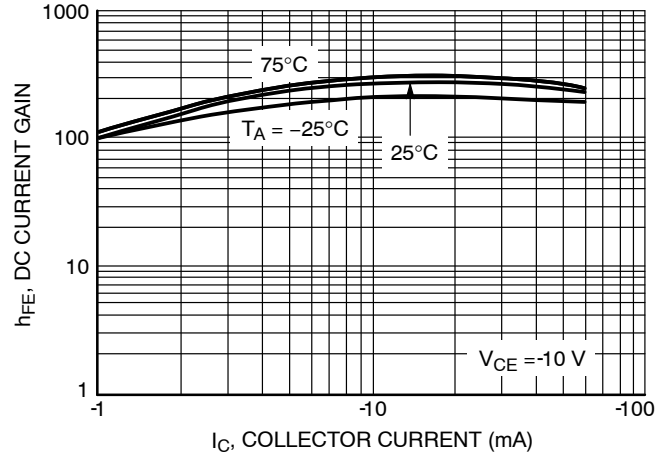

Figure 49. DC Current Gain

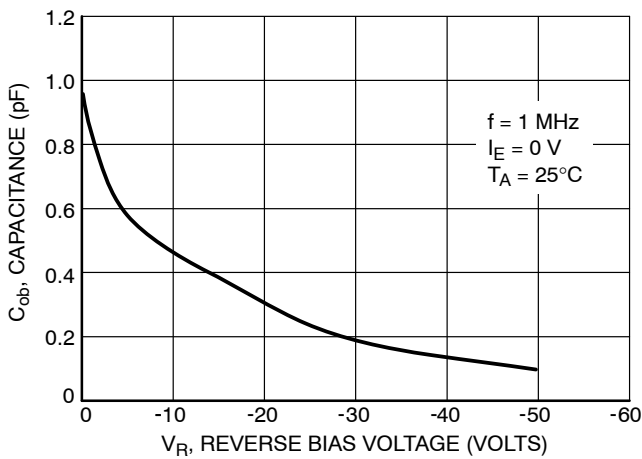

Figure 50. Output Capacitance

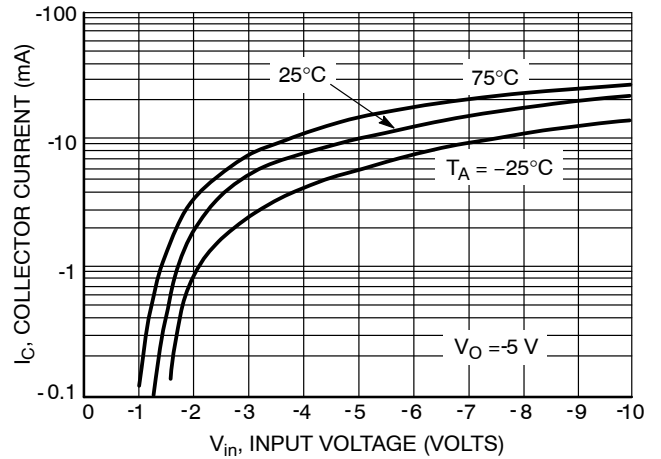

Figure 51. Output Current vs. Input Voltage

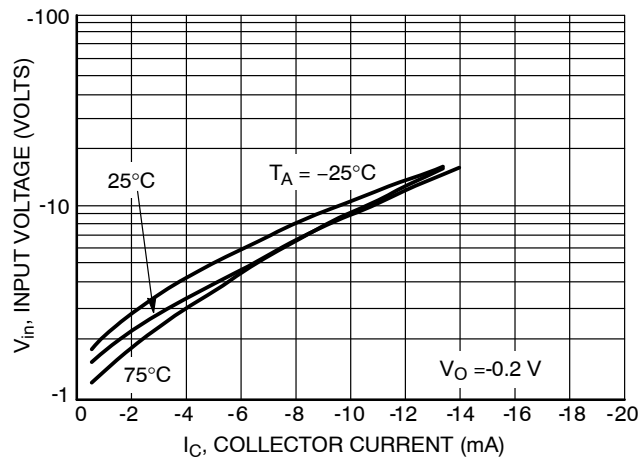

Figure 52. Input Voltage vs. Output Current

TYPICAL ELECTRICAL CHARACTERISTICS
S-LMUN2137LT1G

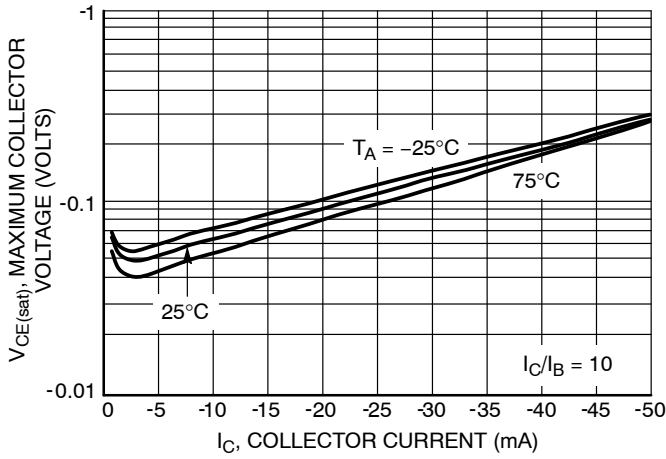

Figure 53. Maximum Collector Voltage vs. Collector Current

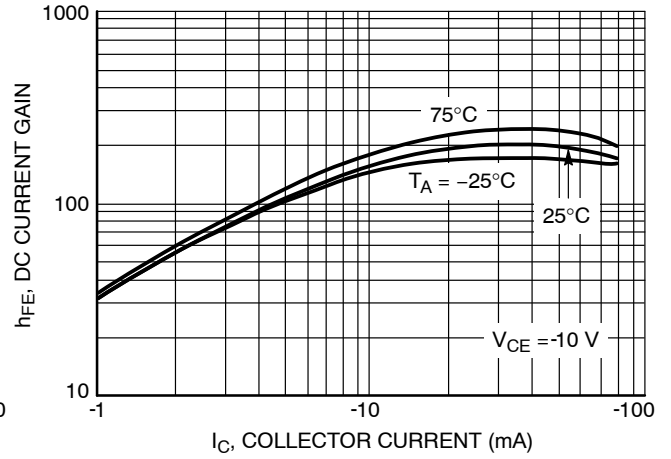

Figure 54. DC Current Gain

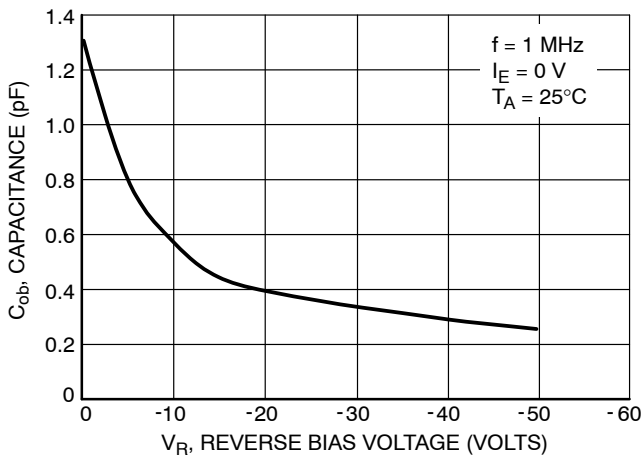

Figure 55. Output Capacitance

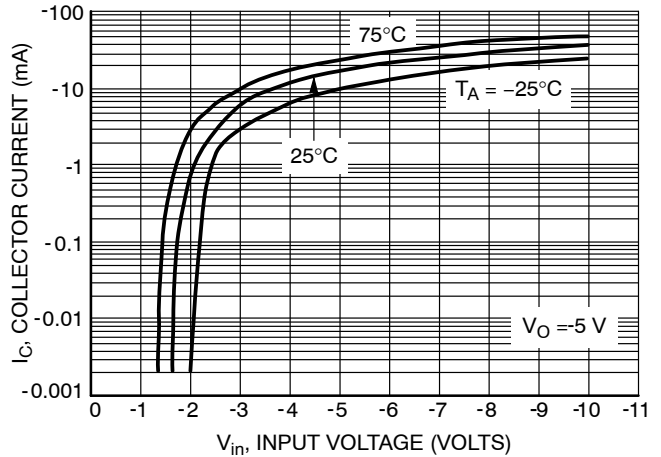

Figure 56. Output Current vs. Input Voltage

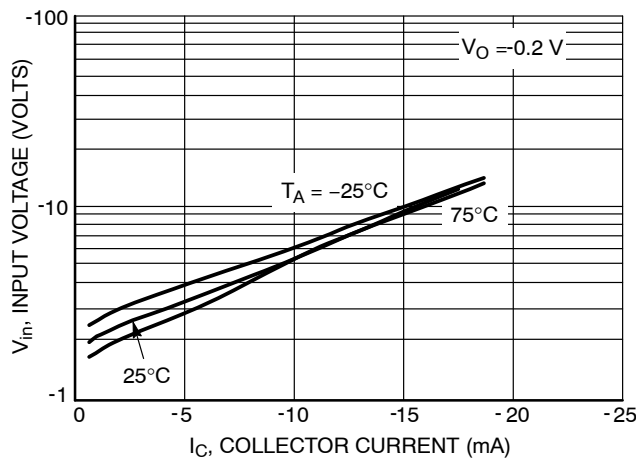

Figure 57. Input Voltage vs. Output Current

S-LMUN2110LT1G Series

OUTLINE AND DIMENSIONS

Notes:

1. DIMENSIONING AND TOLERANCING PER ANSI Y14.5M, 1982.
2. CONTROLLING DIMENSION: MILLIMETERS.
3. MAXIMUM LEAD THICKNESS INCLUDES LEAD FINISH. MINIMUM LEAD THICKNESS IS THE MINIMUM THICKNESS OF BASE MATERIAL.
4. DIMENSIONS D AND E DO NOT INCLUDE MOLD FLASH, PROTRUSIONS OR GATE BURRS.

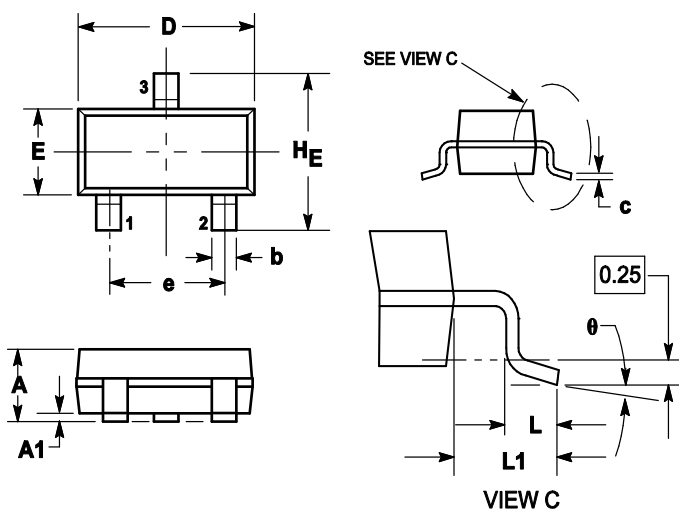

DIM	MILLIMETERS			INCHES		
	MIN	NOM	MAX	MIN	NOM	MAX
A	0.89	1	1.11	0.035	0.04	0.044
A1	0.01	0.06	0.1	0.001	0.002	0.004
b	0.37	0.44	0.5	0.015	0.018	0.02
c	0.09	0.13	0.18	0.003	0.005	0.007
D	2.80	2.9	3.04	0.11	0.114	0.12
E	1.20	1.3	1.4	0.047	0.051	0.055
e	1.78	1.9	2.04	0.07	0.075	0.081
L	0.10	0.2	0.3	0.004	0.008	0.012
L1	0.35	0.54	0.69	0.014	0.021	0.029
HE	2.10	2.4	2.64	0.083	0.094	0.104
θ	0°	---	10°	0°	---	10°

SOLDERING FOOTPRINT

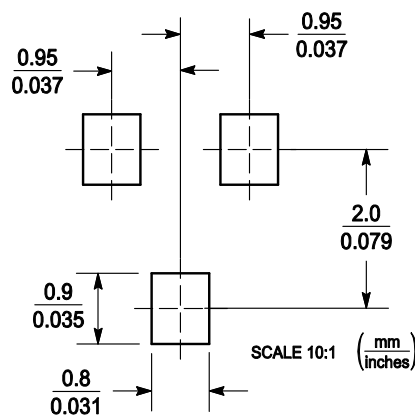

DISCLAIMER

- Curve guarantee in the specification. The curve of test items with electric parameter is used as quality guarantee. The curve of test items without electric parameter is used as reference only.
- Before you use our Products for new Project, you are requested to carefully read this document and fully understand its contents. LRC shall not be in any way responsible or liable for failure, malfunction or accident arising from the use of any LRC's Products against warning, caution or note contained in this document.
- All information contained in this document is current as of the issuing date and subject to change without any prior notice. Before purchasing or using LRC's Products, please confirm the latest information with a LRC sales representative.