

MAPX	MODIFICATION	DATE
------	--------------	------

**Specification:**

**1. Electrical Characteristics:**

Dielectric Withstanding Voltage: AC 500V/1MINUTE.  
 Insulation Resistance: 1000 MΩ/Min.  
 Contact Resistance: 30 mΩ Max.

**2. Mechanical Characteristics:**

INSERTION FORCE: 30N(3.06kgf) MAX  
 EXTRACTION FORCE: 10~30N(1.02~3.06kgf)  
 Durability:1500cycles.EXTRACTION FORCE:10~30N(1.02~3.06kgf)

**3. Material:**

Terminal: C5191/C2680R-EH T=0.25  
 Plating: Gold 0.76 um Min plating over 1.27 um Min Nickel underplate; 2.54 um Min Sn selective plating on solder tail;

Shell: Bronze; SPCC,H =0.30mm  
 Plating: Nickel underplate 2.54 um Min;  
 Housing: PBT PA9T LCP Black White

**4. Environmental:**

Operating Temperature: 0°C to +85°C.

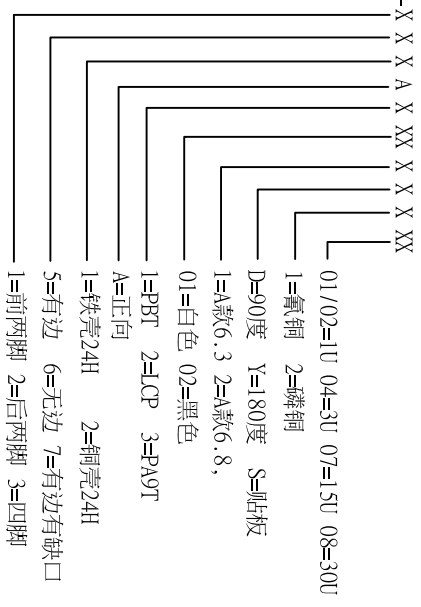
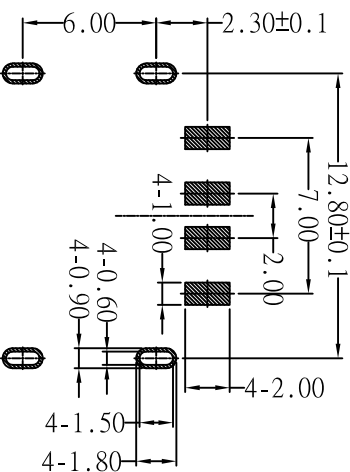
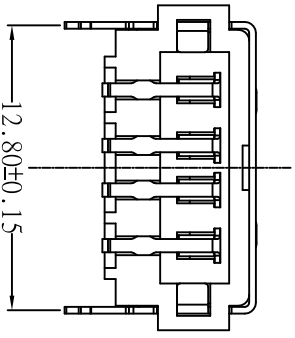
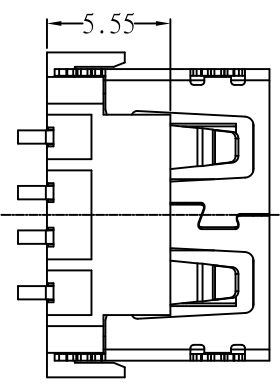
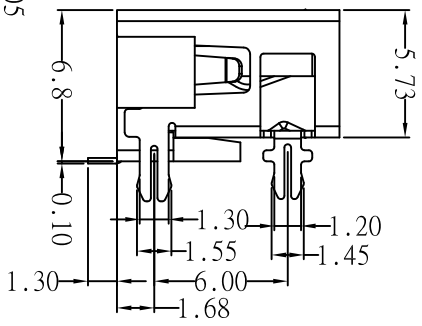
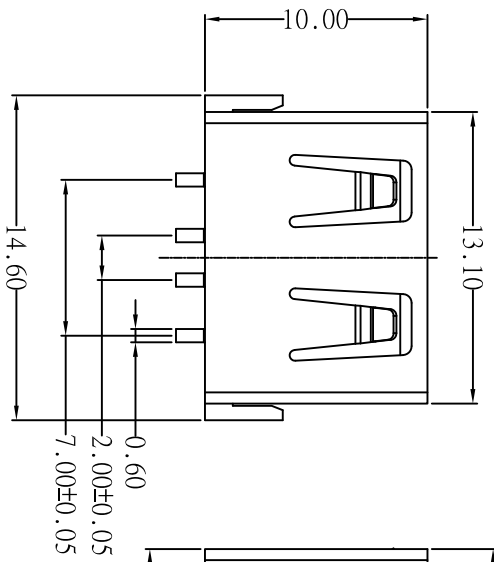
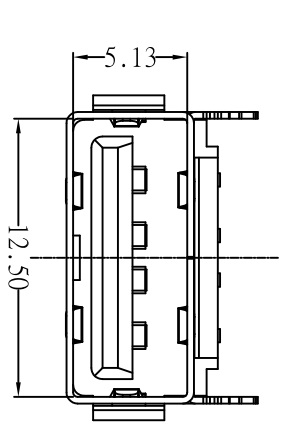
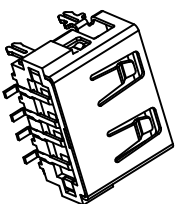

**RECOMMENDED P.C.B LAYOUT**

**深圳市精拓金电子有限公司**

产品图	
PRODUCT CHART DWG	
公差一览表	
TOLERANCE UNLESS OTHERWISE	
X	±0.30
X	±0.25
XX	±0.15
XXX	±0.10
	±5°
	±2°
	±1°
	±0.5°

单位	MM	制图	YANG	制料号	908-362A2022S10100
比例	1:1	审核	郭志富	产品名称	AF10_04款四脚无边铜壳LCP黑款6.8SnIT
日期	2019.11.23	核准	黄国荣	角法	
DATE		APPD		版本	AD

1 2 3 4 5 6 7 8 9 10