

REV.	EC#	DESCRIPTION	DATE	DRAWN	CHECK	APPROVED
1.00		针座设计	2018-04-22			

REV.	EC#	DESCRIPTION	DATE	DRAWN	CHECK	APPROVED
1.00		针座设计	2018-04-22			

REV.	EC#	DESCRIPTION	DATE	DRAWN	CHECK	APPROVED
1.00		针座设计	2018-04-22			

Pin	DIM.A	DIM.B	DIM.C	DIM.D
15	35.00	40.00	42.50	
14	32.50	37.50	40.00	
13	30.00	35.00	37.50	
12	27.50	32.50	35.00	
11	25.00	30.00	32.50	
10	22.50	27.50	30.00	
9	20.00	25.00	27.50	
8	17.50	22.50	25.00	
7	15.00	20.00	22.50	
6	12.50	17.50	20.00	
5	10.00	15.00	17.50	
4	7.50	12.50	15.00	
3	5.00	10.00	12.50	
2	2.50	7.50	10.00	

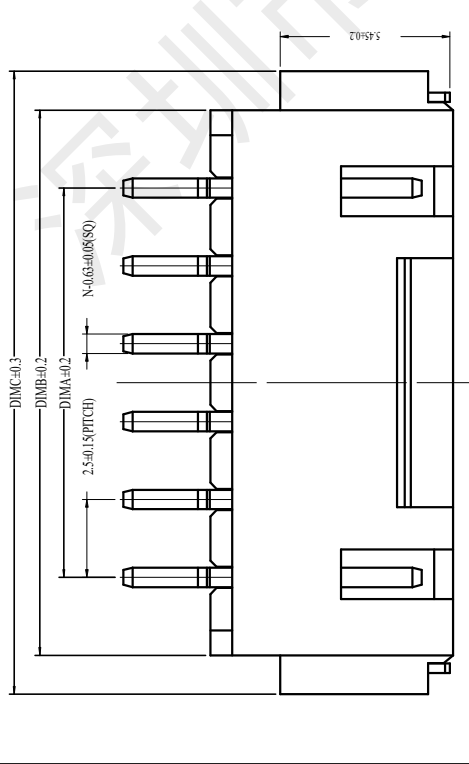
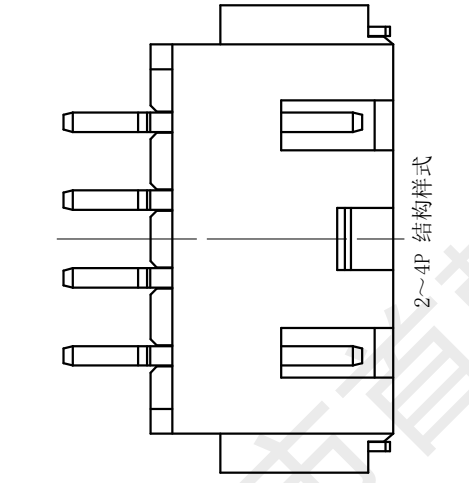
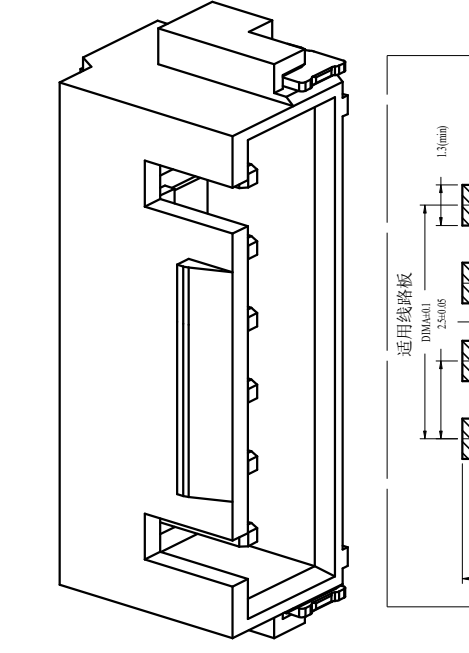

1. 工作温度:  $-25^{\circ}\text{C} \sim 85^{\circ}\text{C}$ .
2. 适用线规: AWG#30~#22.
3. 额定电压: 250V DC/AC (rms).
4. 额定电流: 3.0A.
5. 接触电阻:  $\leq 20\text{m}\Omega$ .
6. 耐压值: 1000V AC/minute.
7. 绝缘电阻:  $\geq 1000\text{M}\Omega$ .

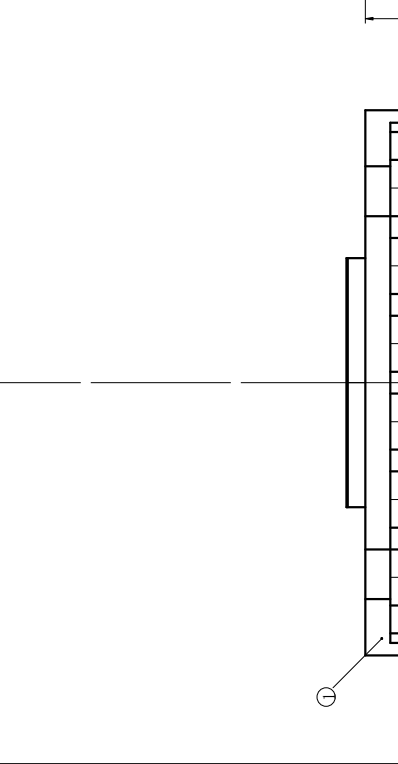
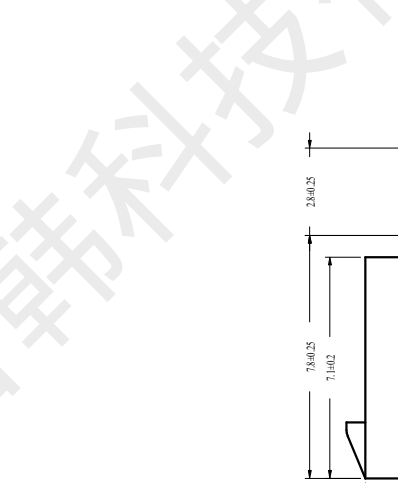
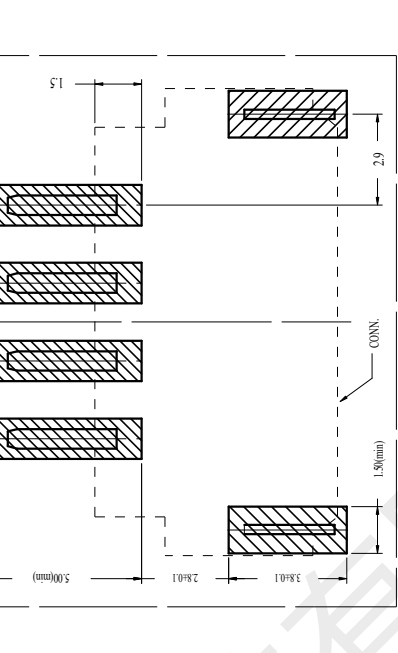

NO.	NAME	QTY	DESCRIPTION
3	FITTING NAIL	2 PCS	材质:磷青铜,电镀:镀亮锡60u"MIN
2	PIN	n PCS	材质:黄铜,电镀:镀亮锡60u"MIN
1	Housing	1 PCS	材质:LCP (UL94V-0),颜色:本色或黑色

NO.	NAME	QTY	DESCRIPTION
3	FITTING NAIL	2 PCS	材质:磷青铜,电镀:镀亮锡60u"MIN
2	PIN	n PCS	材质:黄铜,电镀:镀亮锡60u"MIN
1	Housing	1 PCS	材质:LCP (UL94V-0),颜色:本色或黑色

NO.	NAME	QTY	DESCRIPTION
3	FITTING NAIL	2 PCS	材质:磷青铜,电镀:镀亮锡60u"MIN
2	PIN	n PCS	材质:黄铜,电镀:镀亮锡60u"MIN
1	Housing	1 PCS	材质:LCP (UL94V-0),颜色:本色或黑色

NO.	NAME	QTY	DESCRIPTION
3	FITTING NAIL	2 PCS	材质:磷青铜,电镀:镀亮锡60u"MIN
2	PIN	n PCS	材质:黄铜,电镀:镀亮锡60u"MIN
1	Housing	1 PCS	材质:LCP (UL94V-0),颜色:本色或黑色

SHOON 深圳市首韩科技有限公司

DRAW :	DESIGN :	CHECK :	APPROVED :	CUSTOMER DRAWING
李春风	钟国华	罗孝金		
2018-04-22	2018-04-22	2018-04-22		

DRAW NAME:	TITLE:	SERIES:	P/N:	REV.	SCALE	N/A
2.54mm-8P WTDK	针座	2021 SERIES		1.00		

DIM	TOL	DIM	DEG
X	X°	X°	+3.00°
X.X	-0.15	X.X°	+2.00°
X.XX	-0.25	X.XX°	+1.00°
X.XXX	-0.15	X.XXX°	

DIM	TOL	DIM	DEG
X	X°	X°	+3.00°
X.X	-0.15	X.X°	+2.00°
X.XX	-0.25	X.XX°	+1.00°
X.XXX	-0.15	X.XXX°	



深圳市首韩科技有限公司

SHENZHEN SHOUHAN TECHNOLOGY CO., LTD

Tel: 0755-27597601 Fax: 0755-27597491

# 承 认 书

## SPECIFICATION FOR APPROVAL

客 户 Customer:

\_\_\_\_\_

产品名称 Project:

针座

\_\_\_\_\_

规格型号 Part No:

2.54mm-8P WTDK

\_\_\_\_\_

### 贵公司承认印 Approval signatures

料 号/Part No.	签 章/Signatures

日期 Date:

拟制/Drawn	李春风	
审核/Check	钟华华	
批准/Approved	罗孝金	

## 1、SCOPE: (适用范围)

1.1 This specification covers production and inspection of Connector.

本规范内容适用于本公司普通系列型条形连接器（针座）产品的生产与检验。

## 2、USE CONDITION: (使用条件)

**2.1 Ambient temperature Range:-25℃~+85℃**

环境温度：-25℃~+85℃

**2.2 Applicable PC board thickness:1.2~1.6mm**

适用 PC 板厚度：1.2~1.6 mm

## 3、Appearance and Dimension: (外观及尺寸)

**3.1 Appearance:Product surface without defect、dirt、crack、and mechanical damang, Contact without rust,plating not oxided and not peeled.**

产品表面不应有对制品有害的缺陷、污垢、裂痕及机械损伤；接触件无锈蚀、镀层氧化、脱落等现象。

**3.2 Dimension:According to drawings**

外形尺寸：依照附图

**3.3 Exchangable:Exchangable with same specification products.**

互换性：相同规格应能互换

## 4、Material:

材 料 （以图纸为准）

P/N 零件名称	Type 类 型	Material 材 料	Finish 表面处理	Expiain 说 明
Terminal 端子	Contact 插 簧	Phosphor bronze 锡青磷铜 厚 0.15mm	Tin Plating:3~4 μ m 镀锡：3~4 μ m	RoHS Comp liant
Housing 孔 座	Plastic 塑 壳	Nylon66 UL94V-0	Color:White 颜色：白色	
OpeningWafer 开口针座	Contact 插 针	Phosphor bronze 锡青磷铜 厚 0.30mm	Tin Plating:3~4 μ m 镀锡：3~4 μ m	
	Plastic 塑 壳	Nylon46 UL94V-0	Color: Beige 颜色：米色	
Lips Wafer 闭口针座	Contact 插 针	Phosphor bronze 锡青磷铜 厚 0.30mm	Gold Plating:3~4 μ " m 镀金：3~4 μ " m	
	Plastic 塑 壳	PBT UL94V-0	Color: White 颜色：白色	
Tiepian Wafer 卧贴针座 立贴针座	Contact 插 针	Phosphor bronze 锡青磷铜 厚 0.30mm	Tin Plating:3~4 μ m 镀锡：3~4 μ m	
	Solder tabs 焊护耳	Phosphor bronze 锡青磷铜 厚 0.25mm	Tin Plating:3~4 μ m 镀锡：3~4 μ m	
	Plastic 塑 壳	Nylon46 UL94V-0	Color: Beige 颜色：米色	

## 5、Electrical Performance:

电气性能

NO. 序号	Item 项目	Requirement 技术要求
5.1	Voltage Rated 额定电压	250V AC DC
5.2	Current Rated 额定电流	3A AC DC
5.3	Contact Resistance 接触电阻	$\leq 20 \text{ m}\Omega$
5.4	Insulation Resistance 绝缘电阻	$\geq 1000 \text{ M}\Omega$
5.5	Dielectric Strength 耐压	$\geq 1000 \text{ V AC/minute}$

## 6、Mechanical Performance:

机械性能

NO. 序号	Item 项目	Requirement 技术要求
6.1	Male contact Retention force PIN 针固定力	$\geq 10 \text{ N}$ per pin
6.2	Female contact Retention force 端子固定力	$\geq 10 \text{ N}$ per pin
6.3	Plug-in force 插入力	$\leq 3 \text{ N}$ per pin
6.4	Plug-out force 拔出力	$\geq 0.5 \text{ N}$ per pin

## 7、Endurance Characteristics:

环境性能

NO. 序号	Item 项目	Requirement 技术要求
7.1	Soldering rest 可焊性	Time: $2.5 \pm 0.5 \text{ S}$ 时间: $2.5 \pm 0.5 \text{ S}$ Temperature: $260 \pm 5^\circ \text{C}$ 温度: $260 \pm 5^\circ \text{C}$ Area of Soldering: $\geq 95\%$ 焊锡面积: $\geq 95\%$
7.2	Resistance to soldering Heat 耐焊接热	Time: $5 \pm 1 \text{ S}$ 时间: $5 \pm 1 \text{ S}$ Temperature: $260 \pm 5^\circ \text{C}$ 温度: $260 \pm 5^\circ \text{C}$ Appearance: NO Damage 外观: 无损坏

7.3	<b>Heat test</b> 耐热性	Time:96h 时间: 96 小时 Temperature:+85±3℃ 温度: +85±3℃ Appearance:NO Damage 外观: 无损坏 Contact resistance: ≤20 mΩ 接触电阻: ≤20 mΩ
7.4	<b>Cold test</b> 耐冷性	Time:48h 时间: 48 小时 Temperature:-25±3℃ 温度: -25±3℃ Appearance:NO Damage 外观: 无损坏 Contact resistance:≤20 mΩ 接触电阻: ≤20 mΩ
7.5	<b>Temperature Cycling</b> 温度循环	Low temperature:-25±3℃ 低温: -25±3℃ High temperature:-85±3℃ 高温: -85±3℃ For 5 cycles.test after keeping in Normal Condition for 30 min. 5 次循环后, 放置在正常环境中 30 分钟, 在进行测试 Appearance: NO Damage 外观: 无损坏 Contact resistance: ≤20 mΩ 接触电阻: ≤20mΩ
7.6	<b>Invariab lenes humidity</b> 恒定湿热	Temperature:60±2℃ 温度: 60±2℃ Relative humidity:90%-96% RH 相对湿度: 90%-96% RH Tim:96h 时间: 96 小时 Appearance:NO Damage 外观: 无损坏 Contact resistance: ≤20 mΩ 接触电阻: ≤20 mΩ Insulation Resistance: ≥100MΩ 绝缘电阻: ≥100 MΩ
7.7	<b>Salt Spray</b> 盐雾试验	Salt concentration: 5±1% 浓度: 5±1% Temperature:35±2℃ 温度: 35±2℃ Tim:16±2h 时间: 16±2 小时 After salt is removed by running wafer and A drop is removed ,it is measured. 把试验样品从试验箱顶悬挂下来, 采用浓度 (5±1) %的氯化钠溶液, 连续雾化 16 小时, 试验后用流动的蒸馏水 轻轻洗去表面沉积物, 在常温常驻湿条件下恢复 1-2 小时, 外观无损伤 Appearance:NO Damage 外观: 无损坏 Contact resistance: ≤20 mΩ 接触电阻: ≤20 mΩ