

GENERAL FEATURES

$V_{(BR)DSS}$	-20V
$R_{DS(ON)}$	8.5m Ω
I_D	-14A

Application

- PWM Applications
- Load Switch

Package and Pin Configuration



SOP-8 top view

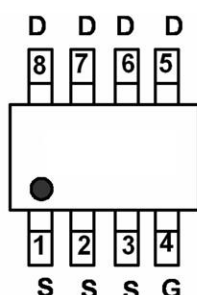

Circuit diagram

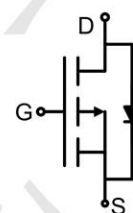

Marking:

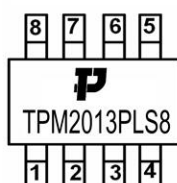

Absolute Maximum Ratings ($T_C=25^{\circ}\text{C}$ unless otherwise specified)

Parameter	Symbol	Rating	Unit
Drain-Source Voltage	V_{DS}	-20	V
Gate-Source Voltage	V_{GS}	± 12	V
Drain Current – Continuous ($T_C=25^{\circ}\text{C}$)	I_D	-14	A
Drain Current – Continuous ($T_C=100^{\circ}\text{C}$)		-8.8	A
Drain Current – Pulsed ¹	I_{DM}	-56	A
Power Dissipation ($T_C=25^{\circ}\text{C}$)	P_D	2	W
Power Dissipation – Derate above 25 $^{\circ}\text{C}$		0.016	W/ $^{\circ}\text{C}$
Storage Temperature Range	T_{STG}	-55 to +150	$^{\circ}\text{C}$
Operating Junction Temperature Range	T_J	-55 to +150	$^{\circ}\text{C}$

Thermal Characteristics

Parameter	Symbol	Typ.	Max.	Unit
Thermal Resistance Junction to Ambient	$R_{\theta JA}$	---	62	$^{\circ}\text{C}/\text{W}$
Thermal Resistance Junction to Case	$R_{\theta JC}$	---	17	$^{\circ}\text{C}/\text{W}$

Electrical Characteristics ($T_J=25^\circ\text{C}$ unless otherwise specified)

Parameter	Symbol	Conditions	Min.	Typ.	Max.	Unit
Off Characteristics						
Drain-Source Breakdown Voltage	BV_{DSS}	$V_{GS}=0V, I_D=-250\mu A$	-20	---	---	V
BV_{DSS} Temperature Coefficient	$\Delta BV_{DSS}/\Delta T_J$	Reference to $25^\circ\text{C}, I_D=-1\text{mA}$	---	-0.01	---	$V/^\circ\text{C}$
Drain-Source Leakage Current	I_{DSS}	$V_{DS}=-20V, V_{GS}=0V, T_J=25^\circ\text{C}$	---	---	-1	μA
		$V_{DS}=-16V, V_{GS}=0V, T_J=125^\circ\text{C}$	---	---	-10	μA
Gate-Source Leakage Current	I_{GSS}	$V_{GS}=\pm 12V, V_{DS}=0V$	---	---	± 100	nA
On Characteristics						
Static Drain-Source On-Resistance	$R_{DS(ON)}$	$V_{GS}=-4.5V, I_D=-8A$	---	6.5	8.5	m Ω
		$V_{GS}=-2.5V, I_D=-5A$	---	9	12	
		$V_{GS}=-1.8V, I_D=-3A$	---	12	17	
Gate Threshold Voltage	$V_{GS(th)}$	$V_{GS}=V_{DS}, I_D=-250\mu A$	-0.3	-0.6	-1	V
Forward Transconductance	g_{fs}	$V_{DS}=-10V, I_S=-5A$	---	20	---	S
Dynamic and Switching Characteristics						
Total Gate Charge ^{2, 3}	Q_g	$V_{DS}=-10V, V_{GS}=-4.5V, I_D=-5A$	---	44.4	80	nC
Gate-Source Charge ^{2, 3}	Q_{gs}		---	7.2	14	
Gate-Drain Charge ^{2, 3}	Q_{gd}		---	10.2	20	
Turn-On Delay Time ^{2, 3}	$T_{d(on)}$	$V_{DD}=-10V, V_{GS}=-4.5V, R_G=25\Omega, I_D=-1A$	---	13.2	26	nS
Rise Time ^{2, 3}	T_r		---	68	120	
Turn-Off Delay Time ^{2, 3}	$T_{d(off)}$		---	160	320	
Fall Time ^{2, 3}	T_f		---	154	300	
Input Capacitance	C_{iss}	$V_{DS}=-15V, V_{GS}=0V, F=1\text{MHz}$	---	4060	8000	pF
Output Capacitance	C_{oss}		---	520	1000	
Reverse Transfer Capacitance	C_{rss}		---	400	800	
Drain-Source Diode Characteristics and Maximum Ratings						
Continuous Source Current	I_S	$V_G=V_D=0V, \text{Force Current}$	---	---	-14	A
Pulsed Source Current	I_{SM}		---	---	-28	A
Diode Forward Voltage	V_{SD}	$V_{GS}=0V, I_S=-1A, T_J=25^\circ\text{C}$	---	---	-1	V

Note:

1. Repetitive Rating: Pulsed width limited by maximum junction temperature.
2. The data tested by pulsed, pulse width $\leq 300 \mu\text{s}$, duty cycle $\leq 2\%$.
3. Essentially independent of operating temperature.

Typical Electrical and Thermal Characteristic Curves

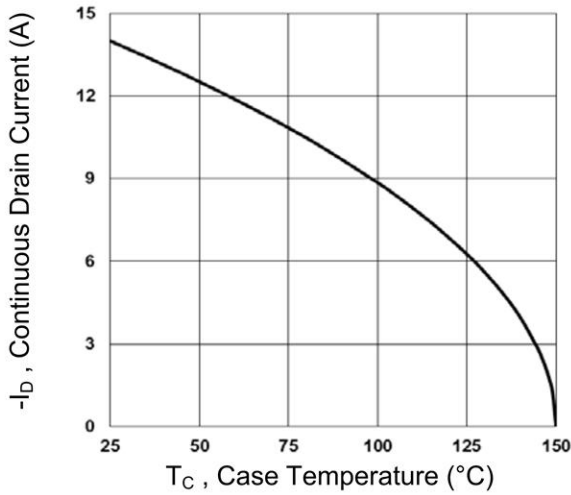

Fig.1 Continuous Drain Current vs. T_c

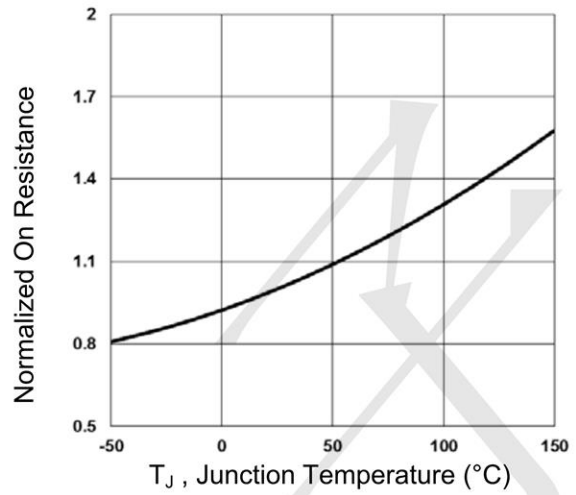

Fig.2 Normalized $R_{DS(ON)}$ vs. T_j

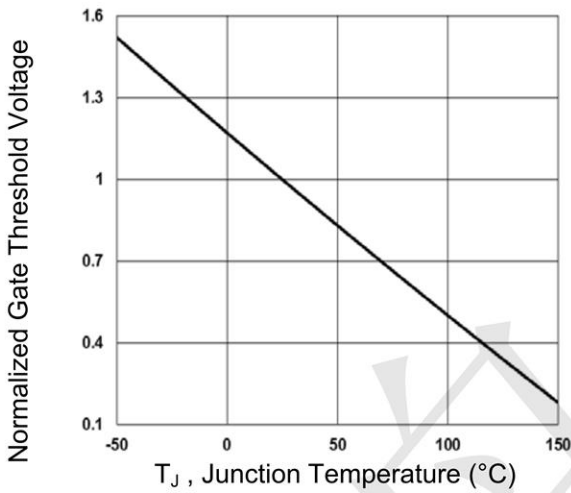

Fig.3 Normalized V_{th} vs. T_j

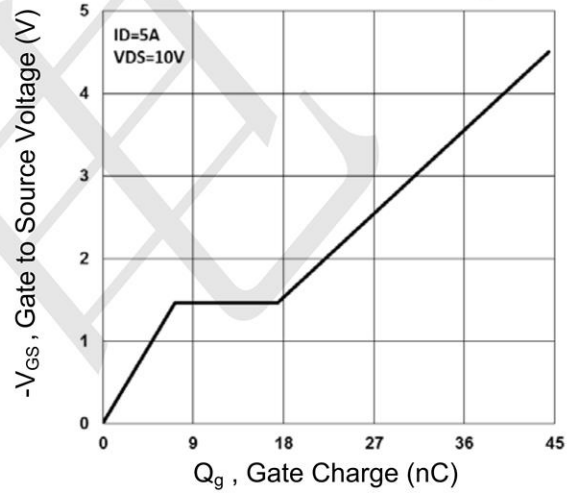

Fig.4 Gate Charge Waveform

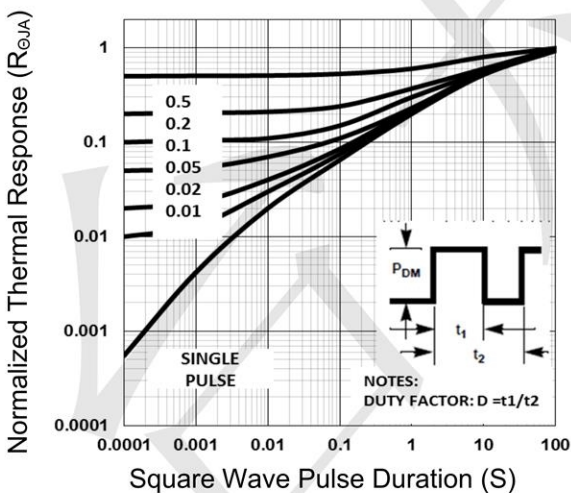

Fig.5 Normalized Transient Response

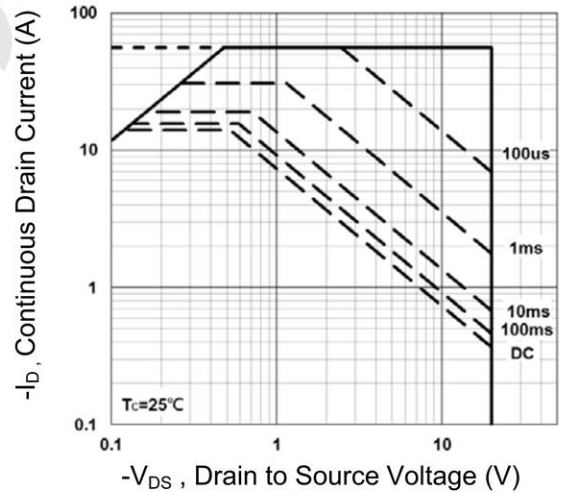

Fig.6 Maximum Safe Operation Area

Typical Electrical and Thermal Characteristic Curves

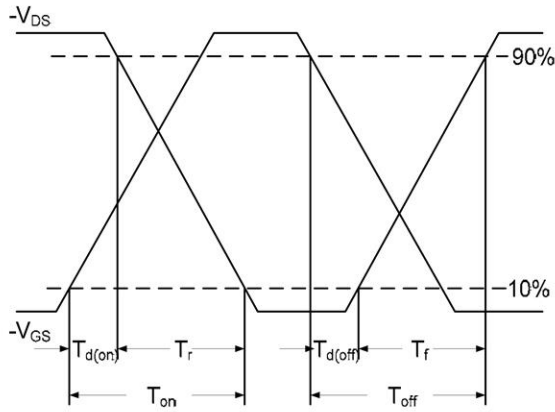

Fig.7 Switching Time Waveform

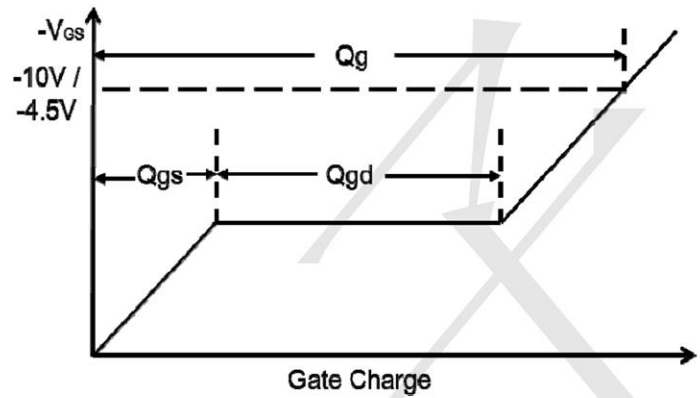
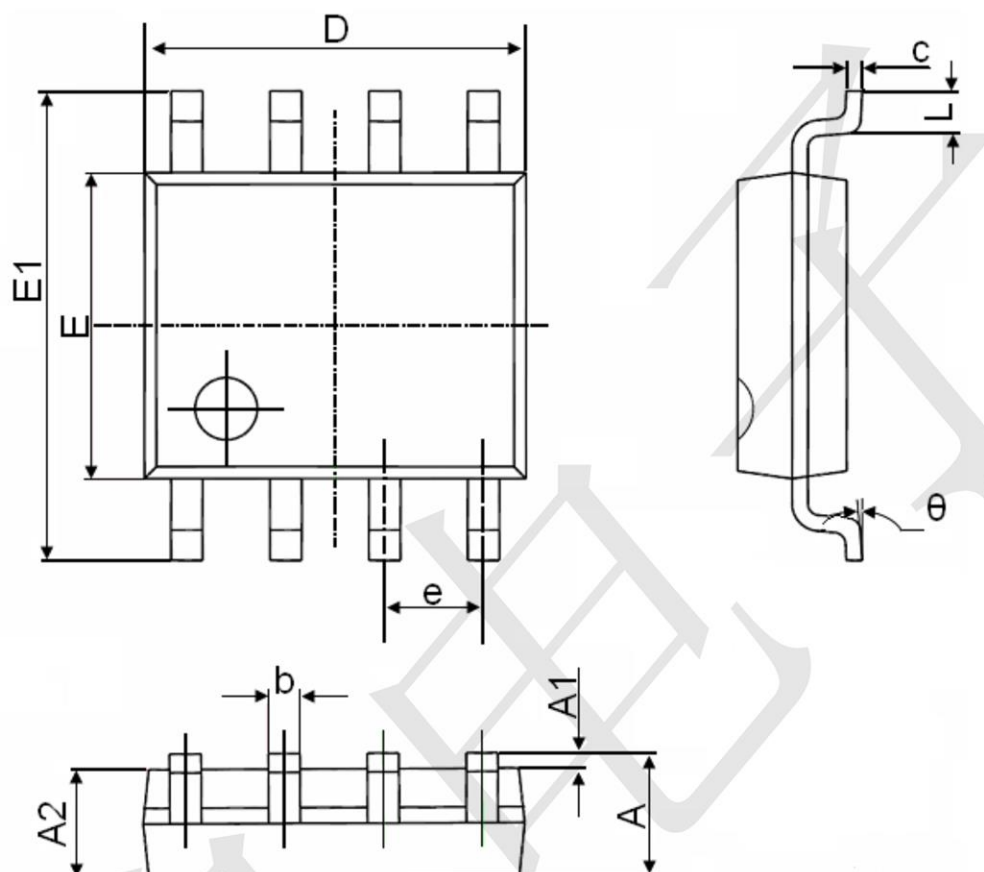

Fig.8 Gate Charge Waveform

SOP-8 Package Information



Symbol	Dimensions In Millimeters		Dimensions In Inches	
	Min.	Max.	Min.	Max.
A	1.350	1.750	0.053	0.069
A1	0.100	0.250	0.004	0.010
A2	1.350	1.550	0.053	0.061
b	0.330	0.510	0.013	0.020
c	0.170	0.250	0.006	0.010
D	4.700	5.100	0.185	0.200
E	3.800	4.000	0.150	0.157
E1	5.800	6.200	0.228	0.244
e	1.270(BSC)		0.050(BSC)	
L	0.400	1.270	0.016	0.050
θ	0°	8°	0°	8°