

厦门赛尔特电子有限公司 Xiamen SET Electronics Co., Ltd.

中国厦门火炬高新区（翔安）产业区翔安西路 8067, 8001 号

No. 8067, 8001 West Xiang'an Road Torch High-Tech Industrial District Xiang'an 361101 Xiamen P. R. CHINA

Tel: +86 592 5715-838 Fax: +86 592 5715-839 E-mail: sales@setfuse.com www.SETfuse.com

规格书
SPECIFICATION
FOR APPROVAL

文件号 Document No.	SET-1001-V-B005
版本 Version	1.0
页数 Page	1 / 14
发行日期 Date of Issue	December 12, 2022
类别 Classification	<input checked="" type="checkbox"/> 参考阶段 Reference <input type="checkbox"/> 样品阶段 Sample <input type="checkbox"/> 正式承认 Qualified <input type="checkbox"/> 工程变更 Changed

产品名称 Product Name	温度保险丝 Thermal-Link(ATCO)		
产品型号 Product Model	V2		
产品编码 Product Code	1000100159001		
产品描述 Product Description	温度保险丝(轴向型) Thermal-Link(Axial Shape) GP V2 115 °C 1 A 250 VAC, 镀锡铜线, 总长 78.5 mm, 外露引线长 36 mm。 Tinned Copper Wire, Total Length 78.5 mm, Outside of Lead Wire 36 mm.		
额定电流&电压 Rated Current & Voltage	1 A, 250 VAC	1 A, 50 VDC	4 A, 60 VDC
认证 Agency Approval	UL, cUL, TUV, PSE, KC, CCC	UL, cUL	UL, cUL, TUV
制造商 Manufacturer	厦门赛尔特电子有限公司 Xiamen SET Electronics Co.,Ltd.		
产地 Country of Origin	中国 China		
 2022.12.12 拟制 Prepared By	 2022.12.12 技术审核 Reviewed By	 2022.12.12 品保核准 Approved By	

客户批准 CUSTOMER APPROVAL

客户名称 Customer Name	深圳市立创电子商务有限公司		
客户料号 Customer P/N			
结论 Conclusion	<input type="checkbox"/> 合格(承认) Qualified <input type="checkbox"/> 不合格 Unqualified 不合格原因: Root Cause:		
生效日期 Effective Date	年 YY	月 MM	日 DD
Name:	Date:	Name:	Date:
经办 Prepared By	审核 Reviewed By	核准 Approved By	

1、 如果本规格获得您的批准, 请签名并拷贝一份副本给我们。

IF YOU APPROVE THIS SPECIFICATION, PLEASE SIGN AND RETURN ONE COPY TO SETsafe | SETfuse.

2、 给赛尔特下订单时, 请在订单中列出上述表格中的: 产品型号、产品编码对应的内容。

PLEASE WRITE THE RELATED PRODUCT MODEL, PRODUCT CODE SHOWN IN THE ABOVE SPECIFICATION INTO THE PURCHASING ORDER(PO) THAT YOU PROVIDE TO SETsafe | SETfuse.

目录 Catalogue

1.	适用范围 Scope	3
2.	术语 Glossary	3
2.1	热熔断体 Thermal-Link (TCO).....	3
2.2	合金型温度保险丝 Alloy Thermal-Link(ATCO)	3
2.3	额定动作温度 Rated Functioning Temperature (T_f).....	3
2.4	实测熔断温度 Fusing Temperature	3
2.5	保持温度 Holding Temperature (T_h)	3
2.6	极限温度 Maximum Temperature Limit (T_m).....	3
2.7	额定电流 Rated Current (I_f).....	3
2.8	额定电压 Rated Voltage (U_f).....	4
3.	结构尺寸 Structure and Dimensions	4
3.1	结构图 Structure	4
3.2	主要原材料明细 Main Material List	4
3.3	尺寸 Dimensions (mm).....	4
4.	安规认证 Agency Approvals	5
5.	环保 Environment	5
6.	技术参数 Specifications	5
7.	检验方法和标准 Inspection Method & Standards	5
8.	安全预防措施 Safety Precautions	7
9.	标示及包装 Marks and Package	11
9.1	产品本体标示 Marking on Product	11
9.2	包装标示事项 Marking on Package	11
9.3	包装 Packaging	12
10.	产品批号&追溯号识别 Lot No. & Tracking No. System	12
10.1	产品批号识别 Lot No. System	12
10.2	产品追溯号识别 Tracking No. System.....	12
11.	储存条件和有效日期 Storage Conditions and Effective Date	12
12.	有效性 Validity	13
12.1	修订协议 Agreement of Revision	13
12.2	有效性 Validity	13
13.	履历 Revision History	14

1. 适用范围 Scope

本规格书适用于合金型温度保险丝 V2（以下简称合金型温度保险丝）之规定。

The specification is available for Alloy Thermal-Link(ATCO) product, and the product mode is V2, hereinafter referred to as Alloy Thermal-Link.

2. 术语 Glossary

2.1 热熔断体 Thermal-Link (TCO)

热熔断体也称为热断路器或温度保险丝，在本文中这些不同名词都代表同样的产品，为一次性动作而不可复位的装置。

A non-resettable device incorporating a THERMAL ELEMENT which will open a circuit once only when exposed for a sufficient length of time to a temperature in excess of that for which it has been designed.

2.2 合金型温度保险丝 Alloy Thermal-Link(ATCO)

合金型温度保险丝，由易熔合金作为感温部件的热熔断体。

Alloy Type Thermal-Link, Alloy is the thermal element.

2.3 额定动作温度 Rated Functioning Temperature (T_f)

通 10 mA 的负载电流时，加热使合金型温度保险丝断开的温度。

The temperature of the Alloy Thermal-Link which causes it to change the state of conductivity with a detection current up to 10 mA as the only load.

Tolerance: $T_f^{+0}_{-10}$ °C (GB/T 9816, EN 60691, K60691).

Tolerance: $T_f \pm 7$ °C (J60691).

2.4 实测熔断温度 Fusing Temperature

置于油池中，通 10 mA 以下的负载电流，每分钟升温 0.5 °C ~ 1 °C，测断开温度。

The temperature of the Alloy Thermal-Link which causes it to change its state of conductivity is measured with silicone oil bath in which the temperature is increased at the rate of 0.5 °C to 1 °C / minute, with a detection current up to 10 mA as the only load.

2.5 保持温度 Holding Temperature (T_h)

持续通额定电流 168 小时不断开的最高温度。

The Maximum temperature at which a Alloy Thermal-Link will not change its state of conductivity when conducting rated current for 168 hours.

2.6 极限温度 Maximum Temperature Limit (T_m)

在规定的时间内不破坏机械和电气特性所能承受的最高温度。

The temperature of the Alloy Thermal-Link stated by the manufacturer, up to which the mechanical and electrical properties of the Alloy Thermal-Link having changed its state of conductivity, will not be impaired for a given time.

2.7 额定电流 Rated Current (I_r)

合金型温度保险丝分类用，允许用于电路并安全断开的最大电流。

The current used to classify a Alloy Thermal-Link, which is the Maximum current that Alloy Thermal-Link allows to carry and is able to cut off the circuit safely.

2.8 额定电压 Rated Voltage (U_r)

合金型温度保险丝分类用，允许用于电路并安全断开的最高电压。

The voltage used to classify a Alloy Thermal-Link, which is the Maximum voltage that Alloy Thermal-Link allows to carry and is able to cut off the circuit safely.

3. 结构尺寸 Structure and Dimensions

3.1 结构图 Structure

合金型温度保险丝由易熔合金、助熔断剂、外壳、封口树脂及引脚等组成。

Alloy Thermal-Link is made up of fusible alloy, flux resin, case, sealant and lead wire.



图 FIGURE 1

3.2 主要原材料明细 Main Material List

编号 NO.	零件名 Part Name	材质 Materials
1	外壳 Case	陶瓷 Ceramic
2	封口树脂 Sealant	环氧树脂 Epoxy
3	引脚 Lead Wire	镀锡铜线 Tinned Copper Wire

3.3 尺寸 Dimensions (mm)

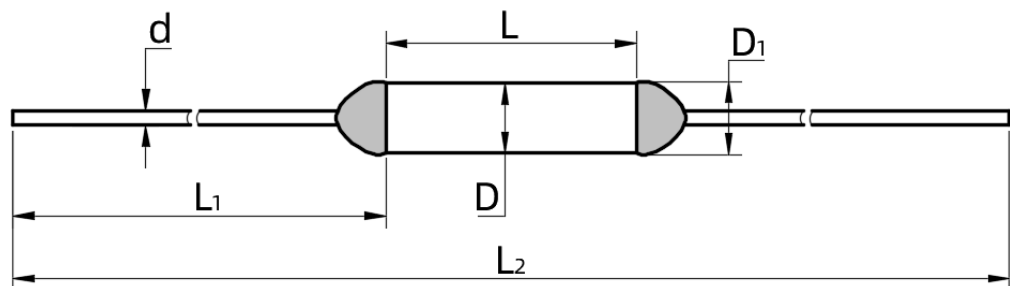

L	L ₁	L ₂	D	D ₁	d
6.5 ± 0.5	36.0 ± 2.0	78.5 ± 3.0	2.1 ± 0.5	≤ 2.6	0.50 ± 0.05

4. 安规认证 Agency Approvals

认证标志 Agency	标准 Standards	认证号 File No.	类别 Category
	UL 60691	E214712	XCMQ2
	CAN-CSA-E60691	E214712	XCMQ8
	EN 60691	R50112716	N/A
	J60691	JET2121-32001-2023	N/A
	K60691	SU05023-11003	N/A
	GB 9816.1	2020980205000185	N/A

5. 环保 Environment

环保 Environment	指令号 Order No.	指令 Order
RoHS	2015/863/EU	满足 RoHS 指令 Meet the RoHS
REACH	2006/1907/EC	满足 REACH 法规 Meet the REACH

6. 技术参数 Specifications

额定动作温度 Rated Functioning Temp. T_f (°C)	实测动作温度 Fuse Temp. (°C)	保持温度 Holding Temp. T_h (°C)	极限温度 Maximum Temp. Limit T_m (°C)	额定电流 Rated Current I_r (A)	额定电压 Rated Voltage U_r (V)	印刷油墨颜色 Color of Printing Ink
115	111 ± 2	91	200	1	AC 250	绿色 Green
					DC 50	
		80		4	DC 60	

7. 检验方法和标准 Inspection Method & Standards

序号 No.	项目 Items	检验工具 Inspection Tools	检验要求 Inspection Requirement	参考标准 Reference Standards
1	外观 Appearance	目视 Visual	在充足光线下观察引脚无氧化发黑。 Observe the lead wire in bright room, and it can't be black for oxidation.	企业标准 Enterprise Standard
2	尺寸 Dimensions	游标卡尺 Calipers	采用游标卡尺测量, 需符合 3.3 要求。 Using caliper measurements, the dimension must meet requirement listed in 3.3.	企业标准 Enterprise Standard

SET safe | **SET fuse**

制造电路控制及安全保护元器件 提供电路安全解决方案

PROVIDING A TOTAL SOLUTION FOR HIGH STANDARD SAFETY CIRCUIT PROTECTION

www.SETfuse.com, E-mail: sales@SETfuse.com

3	拉力 Pull	推拉试验仪 Push Pull Tester	引脚承受 3.93 N 的拉力 1 分钟, 不损伤、脱落。 The lead wire won't be broken down when it is endured a pull force of 3.93 N for 1 min.	IEC60691 及 and UL 60691
4	弯折/扭曲 Bend /twist	扭转工装 Twist Jig	距测试样品本体 10 mm 处, 将一引脚弯曲 90 °, 再扭转 180 °x4 次, 禁止出现损伤、松动。 10 mm away from ontology to test sample, will be a pin bent 90 °, and then turn 180 °x4 times, no damage, loose.	IEC60691 及 and UL 60691
5	动作温度 Function Temperature	动作温度 试验仪 Function Temperature Tester	用油池测量,需符合 6.0 要求。 Test it in a silicon oil bath, the result must meet the requirements list in 6.0.	IEC60691 及 and UL 60691
6	绝缘电阻 Insulation Resistance	耐压试验仪 Voltage Withstand Tester	动作后, 两引脚间绝缘电阻 > 0.2 MΩ, 测试电压为 $2 \times U_r$ (VDC)。 After function under a testing voltage of $2 \times U_r$ (VDC), the insulation resistance between lead wires is at least 0.2 MΩ. 动作后, 引脚与外壳间绝缘电阻 > 2 MΩ, 测试电压为 $2 \times U_r$ (VDC)。 After function under a testing voltage of $2 \times U_r$ (VDC), the insulation resistance between case and lead wires is at least 2 MΩ.	IEC60691 及 and UL 60691
7	电气强度 Electric Strength	耐压试验仪 Voltage Withstand Tester	动作后, 两引脚间承受: $(2 \times U_r) V \times 1$ 分钟, 不击穿。 After function, it won't breakdown when the lead wires endured a voltage of $(2 \times U_r) V$ for 1 min. 动作后, 引脚与外壳间承受: $1000 + (2 \times U_r) V \times 1$ 分钟, 不击穿, 漏电流为 2 mA。 After function, it won't breakdown when a voltage of $1000 + (2 \times U_r) V$ is applied between lead wire and case for 1 min, The leakage current is 2 mA.	IEC60691 及 and UL 60691

检验条件: 温度 25 ± 10 °C、湿度 25 %~75 %

Inspection Conditions: Temperature is 25 ± 10 °C, RH 25 %~75 %

SET safe | **SET fuse**

制造电路控制及安全保护元器件 提供电路安全解决方案

PROVIDING A TOTAL SOLUTION FOR HIGH STANDARD SAFETY CIRCUIT PROTECTION

www.SETfuse.com, E-mail: sales@SETfuse.com

8. 安全预防措施 Safety Precautions

- 8.1 使用中须注意，每个型号的合金型温度保险丝都有其特定的电流、电压规格以及温度规格，包括 T_f （额定动作温度）、 T_h （保持温度）、 T_m （极限温度）以及其电流、电压的规格，详见技术参数表。

Each Alloy Thermal-Link has specific electrical and temperature ratings and must be used with the prescribed ratings. These ratings include T_f (Rated Functioning Temp.), T_h (Holding Temp.), T_m (Maximum Temp. Limit), and the electrical Ratings. Please refer to technical data sheet.

- 8.2 合金型温度保险丝是不可修复的产品。基于安全原因，替换时应使用同类别同型号的合金型温度保险丝并且严格按照同样的方法正确安装。

ATCO is a non-repairable product. For safety sake, it shall be replaced by an equivalent ATCO from the same manufacturer, and mounted in the same way.

- 8.3 安装合金型温度保险丝时要确保其安装位置的环境温度及合金型温度保险丝带载时的产品表面温度不会超过其相应规格中的保持温度。

When mounting Alloy Thermal-Link, please guarantee the ambient temperature of the mounting position and the surface temperature of Alloy Thermal-Link itself at working are not exceeding the holding temperature specified in the related specifications.

- 8.4 终端产品需要确保合金型温度保险丝仅能从预定的热源处（辐射源、对流源、和热传导）感受温度。例如应用于加热器，合金型温度保险丝不能让导线过多受热，这样会加速保险丝熔化断裂；如用于变压器或发动机，温度应该由变压器或发动机线圈控制，这时合金型温度保险丝就需与变压器或发动机线圈之间有良好的热传导。

The terminal product should be designed to ensure that Alloy Thermal-Link detects only from intended heat source (radiant, convection, and conductance). For example, in a heater application, Alloy Thermal-Link lead wires should not be heated so much, because it will accelerate the fusing off of the Alloy Thermal-Link. In transformer or motor application, where the temperature should be controlled by the transformer or motor coil, Alloy Thermal-Link should have good Thermo-coupling with the transformer or motor coil.

- 8.5 建议采用内置热电偶式的仿真合金型温度保险丝来确定适合的温度要求和安装位置。

It is recommended that a dummy ATCO with inbuilt thermo-couple shall be used to determine the proper temp.

- 8.6 勿将合金型温度保险丝安装在可能经常出现剧烈振动的地方。

Do not locate the ATCO in a place where severe vibration always occurs.

- 8.7 需对最终产品进行测试，以确保潜在的异常状况不会导致合金型温度保险丝超过其极限温度。

The terminal product should be tested to ensure that potential abnormal conditions do not cause ambient temp. to exceed the T_m of the ATCO.

8.8 保险丝的封口及主体不能受损，烧伤或者过度受热。
The seal or body of ATCO must not be damaged, burned or over heated.

8.9 安装 Mounting

8.9.1 将合金型温度保险丝安装在可使其温度可以平稳上升的部位。
Mount the ATCO at the location where temp. rises evenly.

8.9.2 确保引脚足够长，且其安装方法不会造成强行按压、拉伸及扭转引脚之现象；外壳安装或固定过程中，请勿用力过猛，以免造成产品断裂或本体损伤。
Ensure that the lead wires is long enough, and avoid actions such as press, tensile or twist ; During the installation or fixing of the shell, do not use excessive force to avoid product break age or body damage.

8.10 引脚弯曲 Lead Wire Bending

8.10.1 如果一定要弯折引脚，那么应确保弯折处与主体间的距离，如表 1。
If the lead wire has to be bent, please pay attention to the distance between ATCO body and bending point. Refer to Table 1.

表 TABLE 1

d	< 1.0 mm	1.0~1.2 mm	> 1.2 mm
L_b	≥ 3 mm	≥ 5 mm	≥ 10 mm



图 FIGURE 2

8.10.2 弯折引脚时请使用钳子或其它工具固定（如图 2 所示），以免损坏产品。
When bending leads, please use pincher or similar tools to fix the product as shown in Fig.2, to avoid damaging the product.

8.10.3 在成形和安装过程中，对引脚进行裁切、切割、弯折时，请勿用力过猛，以免造成产品断裂或本体损伤。
During forming and mounting, lead wire should not be cut, nicked, bent sharply, to avoid breaking the product.

8.10.4 避免直接对引脚根部施加外力（比如与合金型温度保险丝主体成一定角度推或拉），以免损坏合金型温度保险丝封口。
Tangential forces on the leads must be avoided (i.e. pushing or pulling on the leads at angle to ATCO body) as such forces may damage the seal of ATCO.

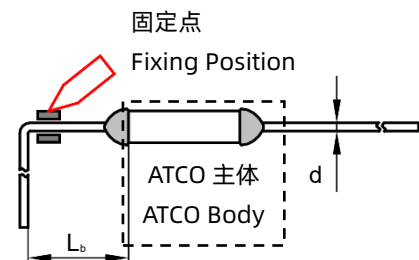
8.11 设计终端产品时应考虑到与引脚接触的零部件因膨胀及收缩所造成的应力、振动或其他运动，应采用柔韧的、易弯曲的引脚或者低阻抗引线来连接合金型温度保险丝。
Stress, vibration or other movement caused by expansion and contraction of the parts connected to the leads should be considered when designing the terminal product. A flexible lead or lead with low resistance should be used to connect the Alloy Thermal-Link.

8.12 应确保接触电阻为最小值，需要对连接点进行检查以确保引脚与被连接物连接可靠，不正确的连接可能造成合金型温度保险丝提前失效，引起封口或其他部份的损坏，并且不良连接产生的高阻抗可能导致器件过热而引起断路或损坏。

Contact resistance should be minimal. Improper connection may cause Alloy Thermal-Link to fail in advance. The joints should be inspected to ensure adequate mechanical bonding of Alloy Thermal-Link leads and connection parts. Improper connections may cause damage to the seal or other parts. Improper connections may cause high resistance, which may result in open circuit or nuisance tripping of the devices.

8.13 与引脚的连接及连接的材料 Connecting leads and connection materials

8.13.1 若需外露一定长度的引脚，应该采取相应措施，防止合金型温度保险丝引脚歪斜或损坏。

If it is necessary to expose the lead of Alloy Thermal-Link, there shall be some measurements to avoid the lead deflection or damage.

8.13.2 所采用的连接材料或夹具应为抗腐蚀材料。

Connection materials or pinchers should be materials of anti-corrosion.

8.13.3 应采用长度及柔韧度充足的引脚，合金型温度保险丝和连接物结合应是可靠的，以避免在正常工作状态下发生的振动或弯折对合金型温度保险丝造成损伤。

Leads should be sufficiently long and flexible. The joints of Alloy Thermal-Link leads and connecting parts should be reliable to avoid the damage caused by the vibration or bending during normal operation.

8.14 引脚焊接 Soldering

8.14.1 手工焊接必须在表 2 所列的条件下进行。

Hand soldering should be carried out according to Table 2.

表 TABLE 2: 焊接时间 Soldering Time (s)

额定温度 Rated Functioning Temp. T_f (°C)	最大允许焊接时间 Max. Allowable Soldering Time (s)			焊接温度 Soldering Temp. (°C)	图示 Show
	引线长度 Length of Lead Wire (L_s)				
	10 mm	20 mm	30 mm		
76~101	1 ^a	2	3	400	
102~115	1 ^a	2	3		
116~135	1 ^a	3	5		
136~150	3	5	5		
151~221	4	6	7		

a: 为防止合金型温度保险丝被焊断，焊接时视需要增加辅助散热装置。

a: Auxiliary Heat Sink Fixture is Required to Avoid ATCO Cutting off Unexpectedly.

8.14.2 $T_f \leq 130^\circ\text{C}$ 的产品不建议使用波峰焊。
Wave soldering is not recommended for products which T_f is lower than 130°C .

8.14.3 波峰焊必须在表 3 所列的条件下进行。
Wave soldering should be carried out under the soldering conditions listed in table 3.



表 Table 3: 波峰焊参数设置 Wave Soldering Parameters Setting

额定动作温度 T_f	不同引线长度对应允许预热温度				预热时间 t_1	最大波峰温度	过锡时间 t_2	冷却时间 t_3
	引线长度	预热温度	引线长度	预热温度				
$^\circ\text{C}$	mm	$^\circ\text{C}$	mm	$^\circ\text{C}$	S	$^\circ\text{C}$	S	S
131~150	≥ 20	80	≥ 30	90	< 60	≤ 260	< 3	≤ 10
151~230	≥ 20	90	≥ 30	100	< 60	≤ 260	< 3	≤ 10

8.14.4 由于合金型温度保险丝中与引脚连接的易熔合金是可熔化的合金，因此不正确的焊接操作（例如：温度过高、焊时长、引脚过短等）可能导致易熔合金被引脚传递的过高热量所影响，从而使得合金型温度保险丝提前断开。

The thermal element of ATCO is fusible alloy with low melting point, which is jointed with ATCO lead wires. Improper soldering operation (too high soldering temp. , too long soldering time, too short lead wire etc.) may transfer more heat to the thermal element and ATCO may open in advance.

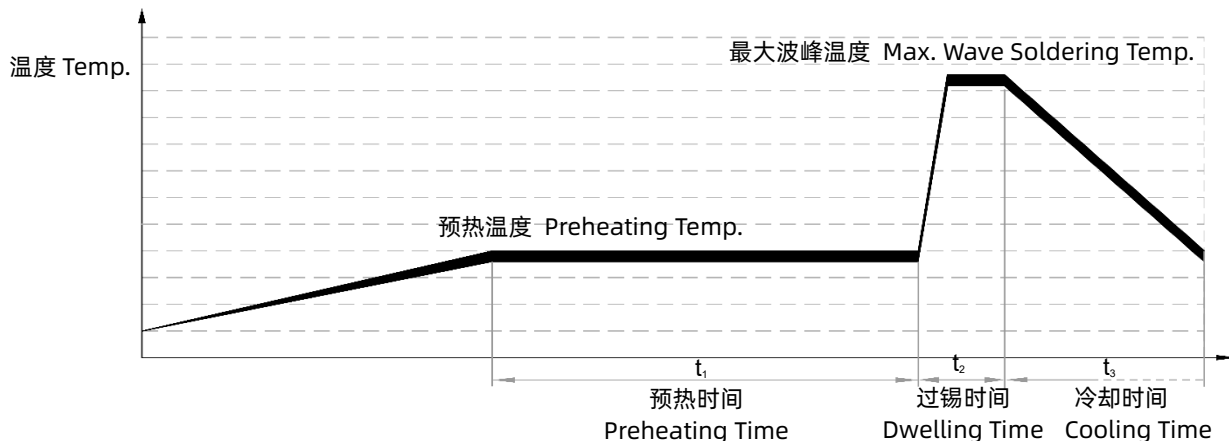
8.14.5 若需要在比表 2 规定更为严苛环境下进行焊接时，应在焊接点和合金型温度保险丝主体间的引脚上使用散热装置。

When soldering conditions are more severe than those listed in Table 2, a heat sink fixture should be used between soldering point and ATCO body.

8.14.6 焊接时应小心，以避免合金型温度保险丝主体和引脚遭受到推/拉力以及扭力。

When soldering, please do not pull / push or twist ATCO body or lead wires.

8.14.7 焊接后应让其自然冷却 20 秒以上，在冷却期间，勿移动合金型温度保险丝本体和引脚。

After soldering, let it naturally cool for longer than 20 seconds. During cooling, never move the ATCO body or lead wires.

- 8.15 安装合金型温度保险丝时应注意防潮。如果合金型温度保险丝是用于咖啡壶、热水器、干燥机、湿度调节器等环境下，那么应将合金型温度保险丝安装在无水泄漏或低湿度的部位。
Mounting Alloy Thermal-Link, damp proof will be considered. If Alloy Thermal-Link is applied to coffeepot, hot water heater, dryer, hygostat, etc., Alloy Thermal-Link should be located at the position where there is no leaking water or low humidity.
- 8.16 安装完成后，应确保整体结构符合应用标准的要求。
After mounting, the whole construction shall comply with the application standards.
- 8.17 在使用产品前，请认真阅读产品使用说明书。
Please carefully read instruction manual before using the product.

9. 标示及包装 Marks and Package

9.1 产品本体标示 Marking on Product

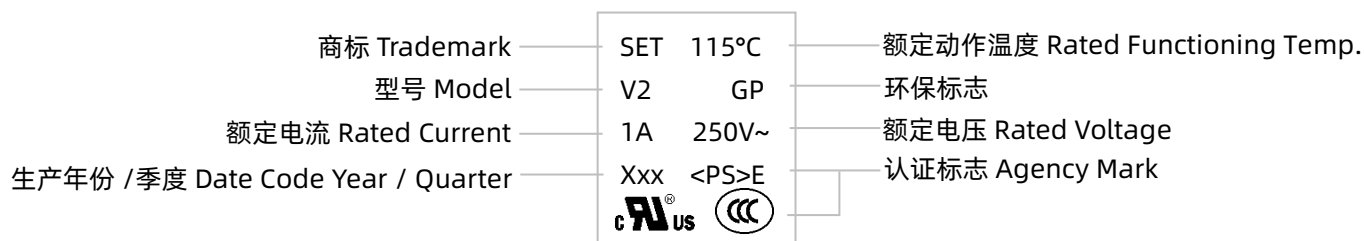

备注：生产年份季度 Xxx，首字母 A 代表 2000 年，B 代表 2001 年；后两位数字 01 代表第一季度，02 代表第二季度，以此类推。

Remark: The first letter of the Date Code Year/quarter A stands for 2000, B stands for 2001, 01 stands for the first quarter, 02 stands for the second quarter, and so on.

9.2 包装标示事项 Marking on Package

- a) 商标 Trademark
- b) RoHS 标志 RoHS Mark
- c) 品名 Product Name
- d) 认证标志 Agency Marks
- e) 型号 Model
- f) 额定动作温度 T_f (Rated Functioning Temp.)
- g) 保持温度 T_h (Holding Temp.)
- h) 极限温度 T_m (Maximum Temp. Limit)
- i) 额定电流 I_r (Rated Current)
- j) 额定电压 U_r (Rated Voltage)
- k) 数量 Quantity
- l) 批号 Lot No.
- m) 标准 Standards
- n) 制造公司名称 Manufacturer's Name

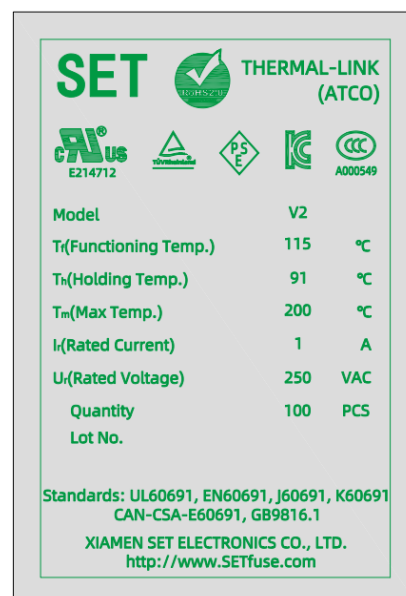

9.3 包装 Packaging

项目 Item	塑料袋 PE Bag	塑料袋 PE Bag	卡通箱 Carton
尺寸 Dimensions (mm)	135 × 85	220 × 190	455 × 315 × 205
数量 Quantity (PCS)	100	1000	50000

备注：包装尺寸及数量仅供参考

Remark: The dimensions and quantity of packaging is for reference only.

包装示意图 Packaging Drawing:

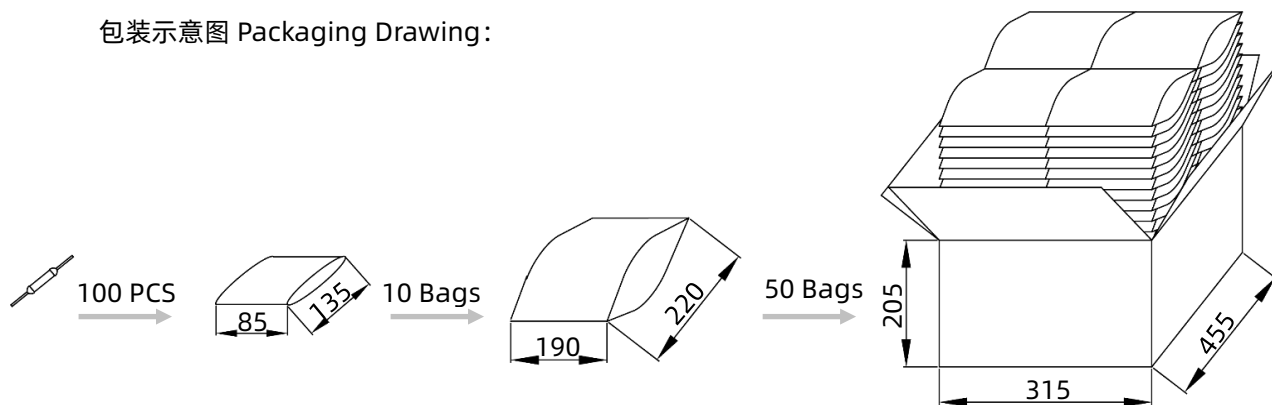

10. 产品批号&追溯号识别 Lot No. & Tracking No. System

10.1 产品批号识别 Lot No. System



图 FIGURE 3 产品批号识别 Lot No. System

10.2 产品追溯号识别 Tracking No. System

外包装追溯号

Tracking No. on the Outer Package:

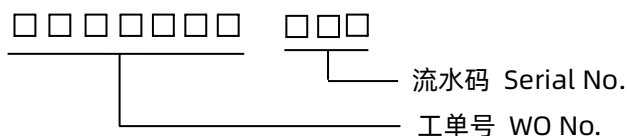

图 FIGURE 4 外包装追溯号 Tracing No. on the Outer Package

11. 储存条件和有效日期 Storage Conditions and Effective Date

温度保险丝的保存期为贵公司入库后 12 个月。温度保险丝必须避免日光照射及污染的环境，且在温度 10 °C~30 °C 、湿度 30 %~70 %的条件下保存。

The validity period of Alloy Thermal-Link is 12 months after you receive it. And Alloy Thermal-Link must be kept in a place with no sunshine or no pollution, with temperature 10 °C to 30 °C and humidity within 30 % to 70 %.

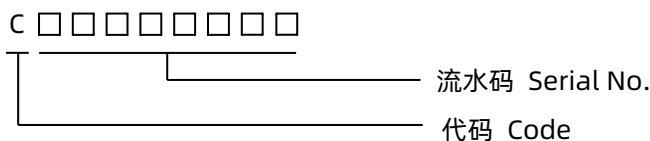
12. 有效性 Validity

12.1 修订协议 Agreement of Revision

本承诺书的内容若有不充分或有必要修订时，得由两公司协议后再行修订。

If the content of this specifications is inadequate or need revising, it will be revised after both parties' agreement.

12.2 有效性 Validity

本承诺书提出后，于贵公司承认期间，可暂时使用，若经过 1 个月后贵公司无异议或无签回承诺书时，则视同有效文件运用。

The specifications can be used temporarily during the period of approval. If you have no any objection or not return one hardcopy to us within one month, this specifications will be operated as a valid document.

-以下无正文 END-

