



SGM2039

Fast Transient Response, 1A, Low Noise, Low Voltage, Low Dropout Linear Regulator

GENERAL DESCRIPTION

The SGM2039 is a low noise, low voltage, fast transient response and low dropout voltage linear regulator which is based on CMOS technology and it provides 1A output current capability. The operating input voltage range is from 1.8V to 5.5V and output voltage range is from 0.8V to 4.2V.

Other features include logic-controlled shutdown mode, short-circuit current limit and thermal shutdown protection. The SGM2039A has automatic discharge function to quickly discharge V_{OUT} in the disabled status.

The SGM2039 is suitable for various applications which need low noise and fast transient response power supply, such as power supply of camera module in smart phones. Fixed or adjustable output voltage versions are provided.

The SGM2039 is available in a Green XTDFN-1.6×1.2-8L package. It operates over an operating temperature range of -40°C to +125°C.

FEATURES

- **Operating Input Voltage Range: 1.8V to 5.5V**
- **Fixed Outputs of 0.8V, 0.9V, 1.0V, 1.05V, 1.1V, 1.2V, 1.8V, 2.5V, 2.8V, 3.0V, 3.3V and 4.2V**
- **Adjustable Output from 0.8V to 4.2V**
- **Quiescent Current: 55µA (TYP)**
- **Low Dropout Voltage:**
88mV (TYP) at 1A, $V_{OUT} = 3.3V$
- **EN Pull-Down Current: 120nA (TYP)**
- **Current Limiting and Thermal Protection**
- **Excellent Load and Line Transient Responses**
- **Stable with Small Case Size Ceramic Capacitors**
- **SGM2039A: With Output Automatic Discharge**
- **SGM2039B: Without Output Automatic Discharge**
- **-40°C to +125°C Operating Temperature Range**
- **Available in a Green XTDFN-1.6×1.2-8L Package**

APPLICATIONS

Battery Powered Equipment
Smart Phone

TYPICAL APPLICATION

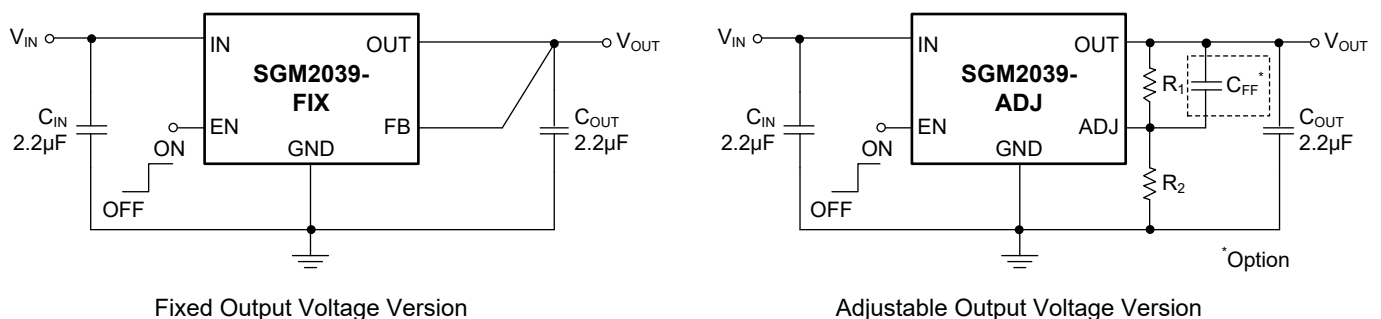

Figure 1. Typical Application Circuits

PACKAGE/ORDERING INFORMATION

MODEL	PACKAGE DESCRIPTION	SPECIFIED TEMPERATURE RANGE	ORDERING NUMBER	PACKAGE MARKING	PACKING OPTION
SGM2039A-0.8	XTDFN-1.6×1.2-8L	-40°C to +125°C	SGM2039A-0.8XXEV8G/TR	S008 XXXX	Tape and Reel, 5000
SGM2039A-0.9	XTDFN-1.6×1.2-8L	-40°C to +125°C	SGM2039A-0.9XXEV8G/TR	S009 XXXX	Tape and Reel, 5000
SGM2039A-1.0	XTDFN-1.6×1.2-8L	-40°C to +125°C	SGM2039A-1.0XXEV8G/TR	S00A XXXX	Tape and Reel, 5000
SGM2039A-1.05	XTDFN-1.6×1.2-8L	-40°C to +125°C	SGM2039A-1.05XXEV8G/TR	S00B XXXX	Tape and Reel, 5000
SGM2039A-1.1	XTDFN-1.6×1.2-8L	-40°C to +125°C	SGM2039A-1.1XXEV8G/TR	S00C XXXX	Tape and Reel, 5000
SGM2039A-1.2	XTDFN-1.6×1.2-8L	-40°C to +125°C	SGM2039A-1.2XXEV8G/TR	S00D XXXX	Tape and Reel, 5000
SGM2039A-1.8	XTDFN-1.6×1.2-8L	-40°C to +125°C	SGM2039A-1.8XXEV8G/TR	S00E XXXX	Tape and Reel, 5000
SGM2039A-2.5	XTDFN-1.6×1.2-8L	-40°C to +125°C	SGM2039A-2.5XXEV8G/TR	S00F XXXX	Tape and Reel, 5000
SGM2039A-2.8	XTDFN-1.6×1.2-8L	-40°C to +125°C	SGM2039A-2.8XXEV8G/TR	S00G XXXX	Tape and Reel, 5000
SGM2039A-3.0	XTDFN-1.6×1.2-8L	-40°C to +125°C	SGM2039A-3.0XXEV8G/TR	S00H XXXX	Tape and Reel, 5000
SGM2039A-3.3	XTDFN-1.6×1.2-8L	-40°C to +125°C	SGM2039A-3.3XXEV8G/TR	S00I XXXX	Tape and Reel, 5000
SGM2039A-4.2	XTDFN-1.6×1.2-8L	-40°C to +125°C	SGM2039A-4.2XXEV8G/TR	S00J XXXX	Tape and Reel, 5000
SGM2039A-ADJ	XTDFN-1.6×1.2-8L	-40°C to +125°C	SGM2039A-ADJXXEV8G/TR	S00K XXXX	Tape and Reel, 5000
SGM2039B-0.8	XTDFN-1.6×1.2-8L	-40°C to +125°C	SGM2039B-0.8XXEV8G/TR	S011 XXXX	Tape and Reel, 5000
SGM2039B-0.9	XTDFN-1.6×1.2-8L	-40°C to +125°C	SGM2039B-0.9XXEV8G/TR	S012 XXXX	Tape and Reel, 5000
SGM2039B-1.0	XTDFN-1.6×1.2-8L	-40°C to +125°C	SGM2039B-1.0XXEV8G/TR	S013 XXXX	Tape and Reel, 5000
SGM2039B-1.05	XTDFN-1.6×1.2-8L	-40°C to +125°C	SGM2039B-1.05XXEV8G/TR	S014 XXXX	Tape and Reel, 5000
SGM2039B-1.1	XTDFN-1.6×1.2-8L	-40°C to +125°C	SGM2039B-1.1XXEV8G/TR	S015 XXXX	Tape and Reel, 5000
SGM2039B-1.2	XTDFN-1.6×1.2-8L	-40°C to +125°C	SGM2039B-1.2XXEV8G/TR	S016 XXXX	Tape and Reel, 5000
SGM2039B-1.8	XTDFN-1.6×1.2-8L	-40°C to +125°C	SGM2039B-1.8XXEV8G/TR	S017 XXXX	Tape and Reel, 5000
SGM2039B-2.5	XTDFN-1.6×1.2-8L	-40°C to +125°C	SGM2039B-2.5XXEV8G/TR	S018 XXXX	Tape and Reel, 5000
SGM2039B-2.8	XTDFN-1.6×1.2-8L	-40°C to +125°C	SGM2039B-2.8XXEV8G/TR	S019 XXXX	Tape and Reel, 5000

Fast Transient Response, 1A, Low Noise, Low Voltage, Low Dropout Linear Regulator

SGM2039

PACKAGE/ORDERING INFORMATION (continued)

MODEL	PACKAGE DESCRIPTION	SPECIFIED TEMPERATURE RANGE	ORDERING NUMBER	PACKAGE MARKING	PACKING OPTION
SGM2039B-3.0	XTDFN-1.6×1.2-8L	-40°C to +125°C	SGM2039B-3.0XXEV8G/TR	S020 XXXX	Tape and Reel, 5000
SGM2039B-3.3	XTDFN-1.6×1.2-8L	-40°C to +125°C	SGM2039B-3.3XXEV8G/TR	S00L XXXX	Tape and Reel, 5000
SGM2039B-4.2	XTDFN-1.6×1.2-8L	-40°C to +125°C	SGM2039B-4.2XXEV8G/TR	S021 XXXX	Tape and Reel, 5000
SGM2039B-ADJ	XTDFN-1.6×1.2-8L	-40°C to +125°C	SGM2039B-ADJXXEV8G/TR	S022 XXXX	Tape and Reel, 5000

MARKING INFORMATION

NOTE: XXXX = Date Code, Trace Code and Vendor Code.

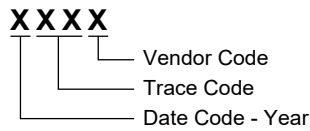

Green (RoHS & HSF): SG Micro Corp defines "Green" to mean Pb-Free (RoHS compatible) and free of halogen substances. If you have additional comments or questions, please contact your SGMICRO representative directly.

ABSOLUTE MAXIMUM RATINGS

IN to GND	-0.3V to 6V
OUT to GND	-0.3V to (V _{IN} + 0.3V)
EN to GND	-0.3V to 6V
Package Thermal Resistance	
XTDFN-1.6×1.2-8L, θ _{JA}	127°C/W
XTDFN-1.6×1.2-8L, θ _{JB}	59°C/W
XTDFN-1.6×1.2-8L, θ _{JC(TOP)}	69°C/W
XTDFN-1.6×1.2-8L, θ _{JC(BOT)}	40°C/W
Junction Temperature	+150°C
Storage Temperature Range	-65°C to +150°C
Lead Temperature (Soldering, 10s)	+260°C
ESD Susceptibility	
HBM	6000V
CDM	1000V

RECOMMENDED OPERATING CONDITIONS

Input Voltage Range	1.8V to 5.5V
Enable Input Voltage Range	0V to 5.5V
Input Effective Capacitance, C _{IN}	0.5µF (MIN)
Output Effective Capacitance, C _{OUT}	1.5µF to 10µF
Operating Junction Temperature Range	-40°C to +125°C

OVERSTRESS CAUTION

Stresses beyond those listed in Absolute Maximum Ratings may cause permanent damage to the device. Exposure to absolute maximum rating conditions for extended periods may affect reliability. Functional operation of the device at any conditions beyond those indicated in the Recommended Operating Conditions section is not implied.

ESD SENSITIVITY CAUTION

This integrated circuit can be damaged if ESD protections are not considered carefully. SGMICRO recommends that all integrated circuits be handled with appropriate precautions. Failure to observe proper handling and installation procedures can cause damage. ESD damage can range from subtle performance degradation to complete device failure. Precision integrated circuits may be more susceptible to damage because even small parametric changes could cause the device not to meet the published specifications.

DISCLAIMER

SG Micro Corp reserves the right to make any change in circuit design, or specifications without prior notice.

PIN CONFIGURATIONS

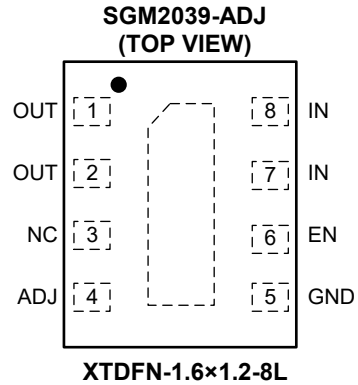
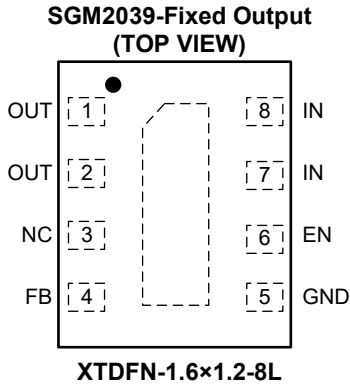

PIN DESCRIPTION

PIN	NAME	FUNCTION
1, 2	OUT	Regulator Output Pin. It is recommended to use a ceramic capacitor with effective capacitance in the range of 1.5μF to 10μF to ensure stability. This ceramic capacitor should be placed as close as possible to OUT pin.
3	NC	No Connection.
4	FB	Feedback Input Pin (fixed voltage version only). Connect this pin directly to the OUT pin.
	ADJ	Adjustable Input Pin (adjustable voltage version only). Connect this pin to the midpoint of an external resistor divider to adjust the output voltage. Place the resistors as close as possible to this pin.
5	GND	Ground Pin.
6	EN	Enable Pin. Drive EN high to turn on the regulator. Drive EN low to turn off the regulator.
7, 8	IN	Input Supply Voltage Pin. It is recommended to use a 2.2μF or larger ceramic capacitor from IN pin to ground to get good power supply decoupling. This ceramic capacitor should be placed as close as possible to IN pin.
Exposed Pad	—	Exposed Pad. Connect it to a large ground plane to maximize thermal performance. This pad is not an electrical connection point.

FUNCTIONAL BLOCK DIAGRAMS

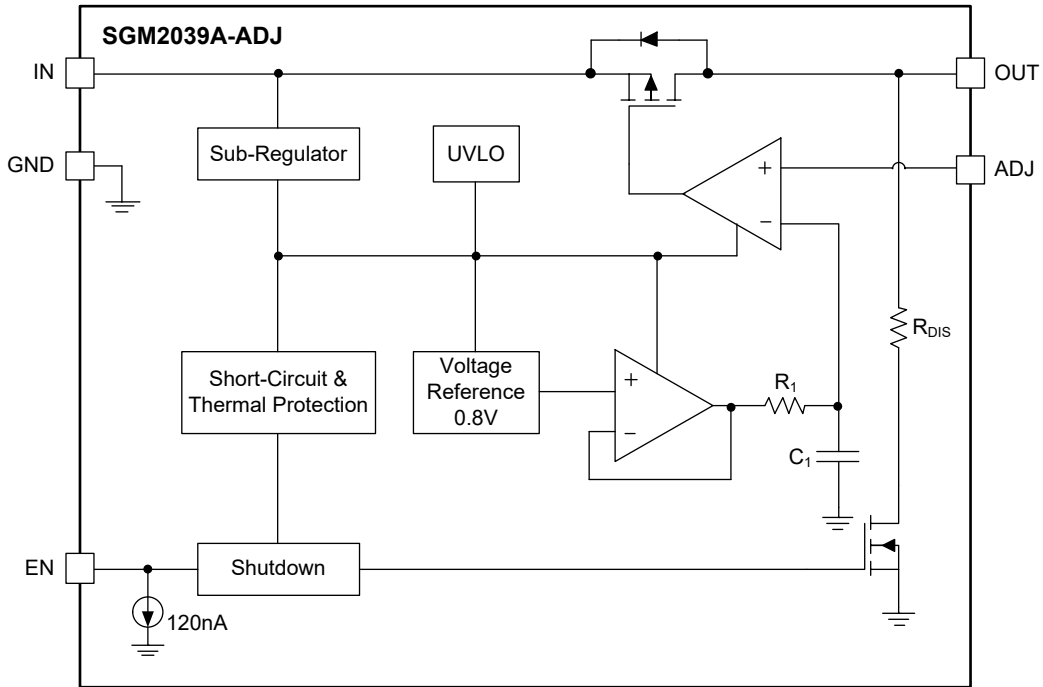

Figure 2. Block Diagram (SGM2039A Adjustable Version)

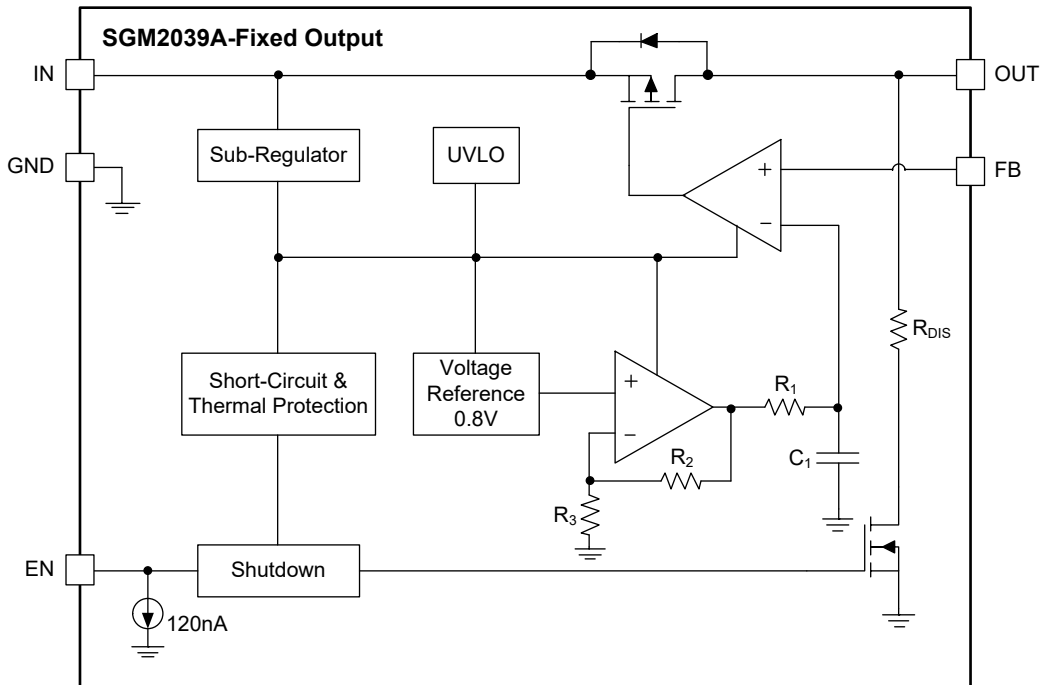

Figure 3. Block Diagram (SGM2039A Fixed Version)

SGM2039 Fast Transient Response, 1A, Low Noise, Low Voltage, Low Dropout Linear Regulator

FUNCTIONAL BLOCK DIAGRAMS (continued)

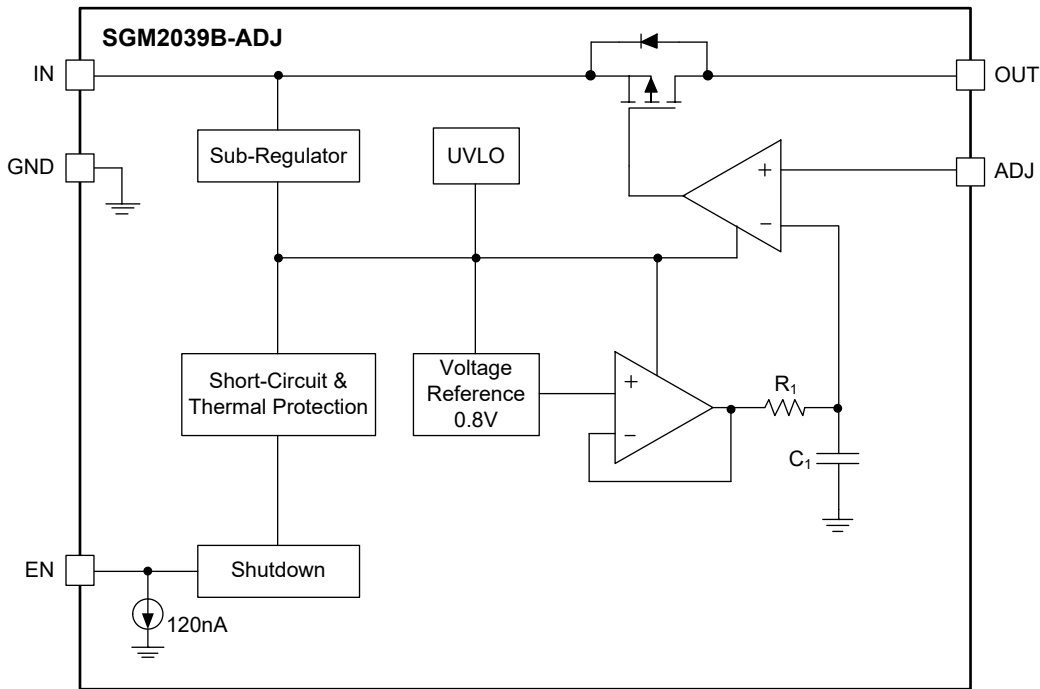

Figure 4. Block Diagram (SGM2039B Adjustable Version)

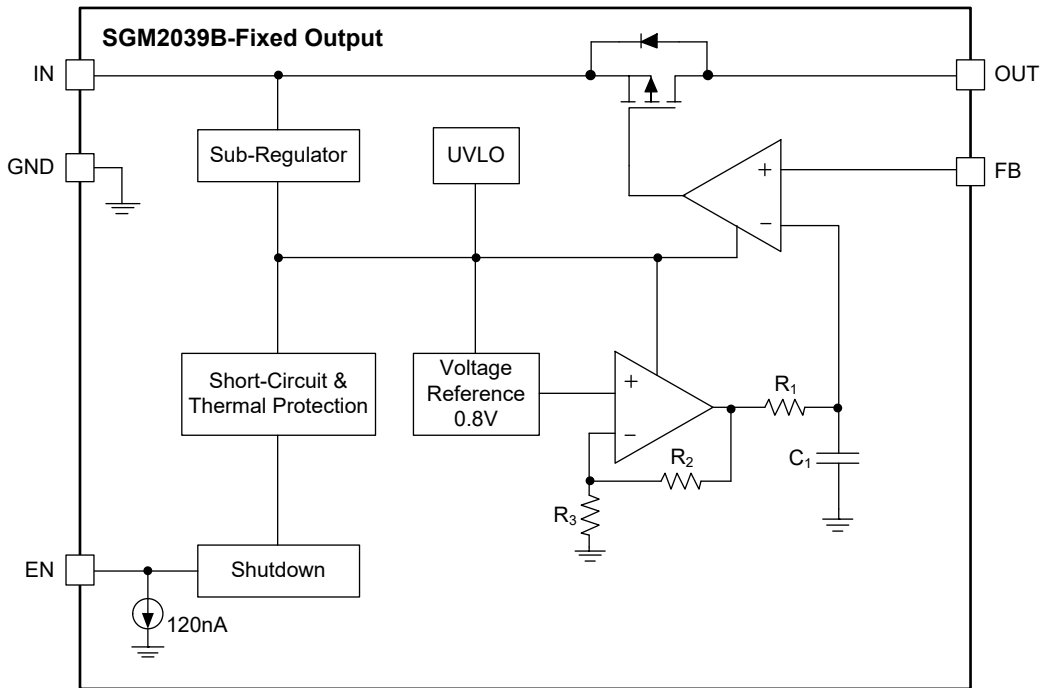

Figure 5. Block Diagram (SGM2039B Fixed Version)

ELECTRICAL CHARACTERISTICS

($V_{IN} = (V_{OUT(NOM)} + 0.5V)$ or 1.8V (whichever is greater), $I_{OUT} = 1mA$, $C_{IN} = 2.2\mu F$, $C_{OUT} = 2.2\mu F$, $V_{EN} = V_{IN}$, $T_J = -40^\circ C$ to $+125^\circ C$, typical values are at $T_J = +25^\circ C$, unless otherwise noted.)

PARAMETER	SYMBOL	CONDITIONS	MIN	TYP	MAX	UNITS	
Operating Input Voltage	V_{IN}		1.8		5.5	V	
Output Voltage Accuracy	V_{OUT}	$V_{IN} = (V_{OUT(NOM)} + 0.5V)$ to 5.5V, $V_{IN} \geq 1.8V$, $I_{OUT} = 1mA$ to 1A	-1		1	%	
Adjustable Reference Voltage	V_{ADJ}	SGM2039-ADJ	0.792	0.8	0.808	V	
ADJ Pin Input Current	I_{ADJ}	$V_{IN} = V_{EN} = 5.5V$, $V_{ADJ} = 0.85V$		± 10	± 20	nA	
Under-Voltage Lockout	V_{UVLO}	V_{IN} rising		1.36	1.65	V	
Line Regulation	$\frac{\Delta V_{OUT}}{\Delta V_{IN} \times V_{OUT}}$	$V_{IN} = (V_{OUT(NOM)} + 0.5V)$ to 5.5V, $V_{IN} \geq 1.8V$, $I_{OUT} = 1mA$		0.006	0.1	%/V	
Load Regulation	ΔV_{OUT}	$I_{OUT} = 1mA$ to 1A		1	8	mV	
Dropout Voltage	V_{DROP}	$I_{OUT} = 1A$, when V_{OUT} falls to ($V_{OUT(NOM)} - 100mV$)	$V_{OUT(NOM)} = 1.2V$		320	450	mV
			$V_{OUT(NOM)} = 1.8V$		160	240	
			$V_{OUT(NOM)} = 2.5V$		110	180	
			$V_{OUT(NOM)} = 2.8V$		97	170	
			$V_{OUT(NOM)} = 3.0V$		92	160	
			$V_{OUT(NOM)} = 3.3V$		88	150	
			$V_{OUT(NOM)} = 4.2V$		76	130	
Output Current Limit	I_{LIMIT}	$V_{OUT} = 90\% \times V_{OUT(NOM)}$	1.0	1.45		A	
Output Short-Circuit Current	I_{SHORT}	$V_{OUT} = 0V$		1.45		A	
Quiescent Current	I_Q	$I_{OUT} = 0mA$		55	120	μA	
Shutdown Current	I_{SHDN}	$V_{IN} = 5.5V$, $V_{EN} = 0V$	$T_J = +25^\circ C$		0.15	1	μA
			$T_J = -40^\circ C$ to $+125^\circ C$			6	
Enable Threshold Voltage	V_{IH}	EN input voltage high	1.0			V	
	V_{IL}	EN input voltage low			0.4		
EN Pull-Down Current	I_{EN}			120	500	nA	
Output Discharge Resistance (SGM2039A option only)	R_{DIS}	$V_{IN} = 5.5V$, $V_{EN} = 0V$, $V_{OUT} = 1.8V$		38		Ω	
Power Supply Rejection Ratio	PSRR	$\Delta V_{RIPPLE} = 0.2V_{P-P}$, $I_{OUT} = 30mA$	$f = 1kHz$		88	dB	
			$f = 1MHz$		40		
Output Voltage Noise	e_n	$f = 10Hz$ to $100kHz$, $I_{OUT} = 30mA$		11		μV_{RMS}	
Thermal Shutdown Temperature	T_{SHDN}			165		$^\circ C$	
Thermal Shutdown Hysteresis	ΔT_{SHDN}			20		$^\circ C$	

SGM2039 Fast Transient Response, 1A, Low Noise, Low Voltage, Low Dropout Linear Regulator

TYPICAL PERFORMANCE CHARACTERISTICS

$T_J = +25^\circ\text{C}$, $V_{IN} = V_{EN} = (V_{OUT(NOM)} + 0.5\text{V})$ or 1.8V (whichever is greater), $I_{OUT} = 1\text{mA}$, $C_{IN} = C_{OUT} = 2.2\mu\text{F}$, unless otherwise noted.

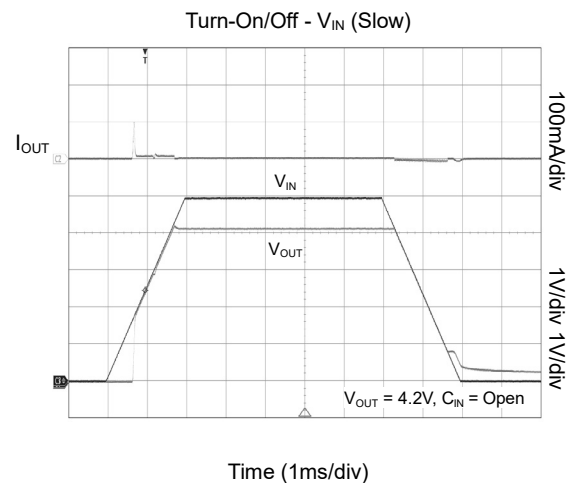
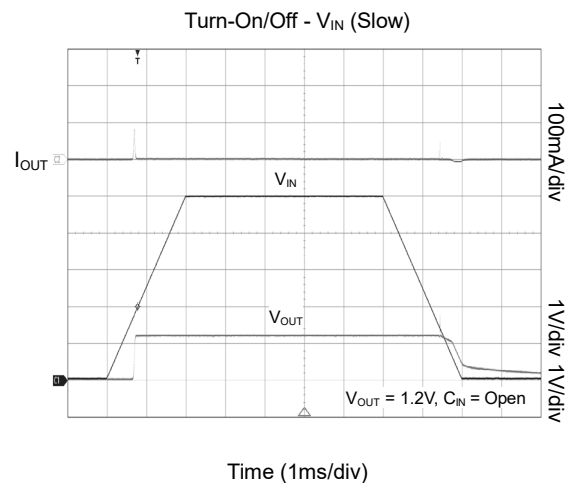
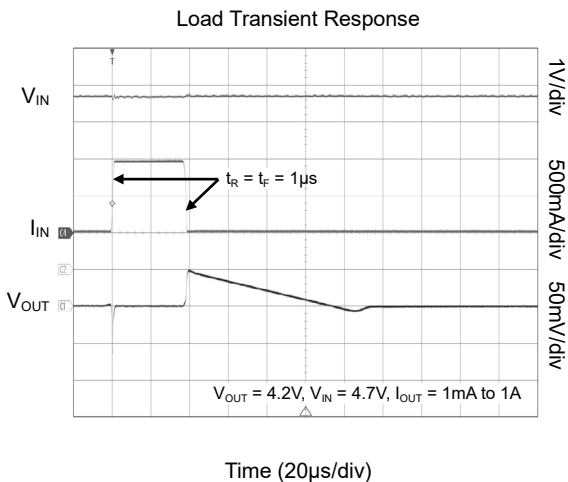
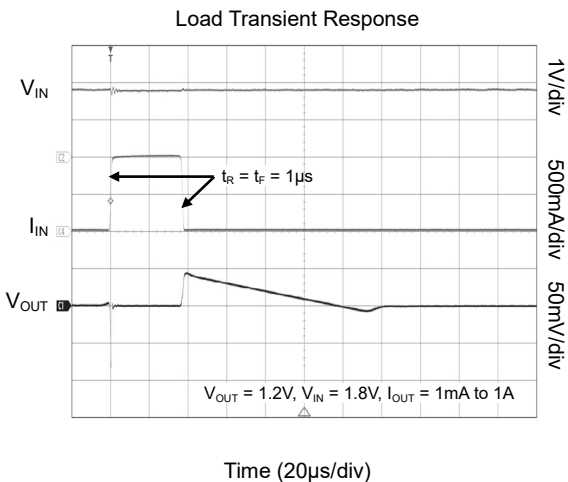
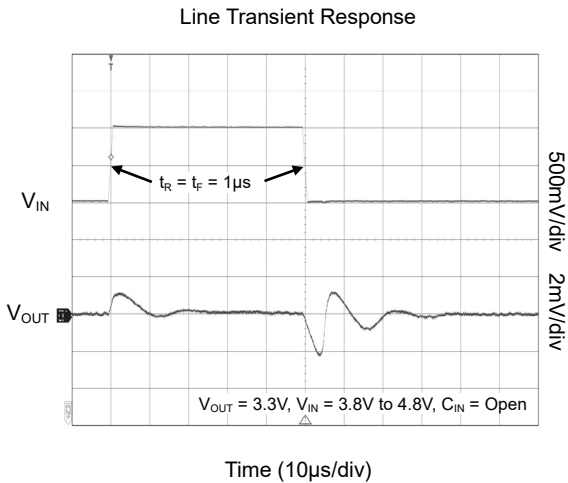
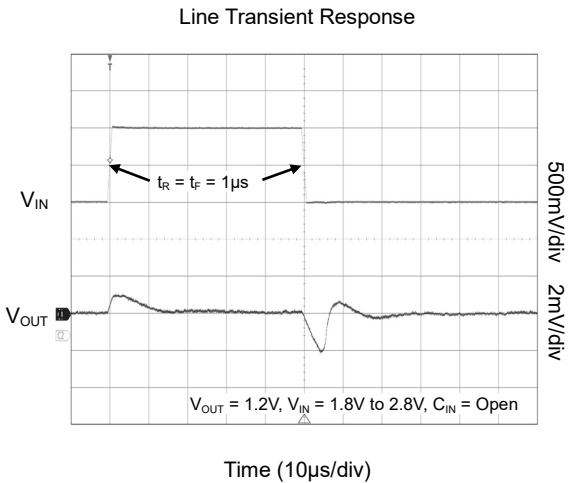

SGM2039 Fast Transient Response, 1A, Low Noise, Low Voltage, Low Dropout Linear Regulator

TYPICAL PERFORMANCE CHARACTERISTICS (continued)

$T_J = +25^\circ\text{C}$, $V_{IN} = V_{EN} = (V_{OUT(NOM)} + 0.5\text{V})$ or 1.8V (whichever is greater), $I_{OUT} = 1\text{mA}$, $C_{IN} = C_{OUT} = 2.2\mu\text{F}$, unless otherwise noted.

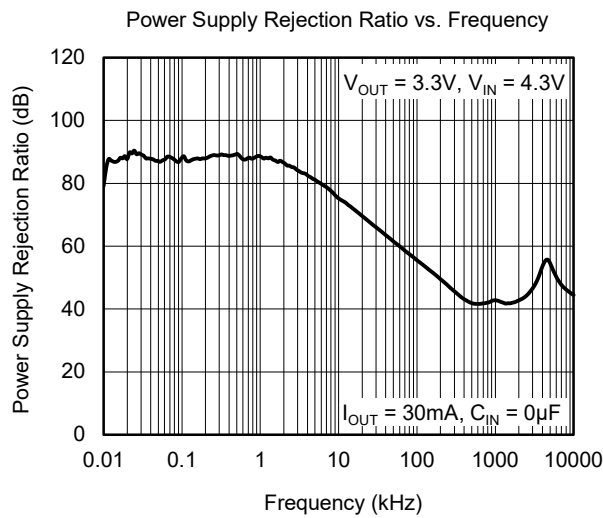
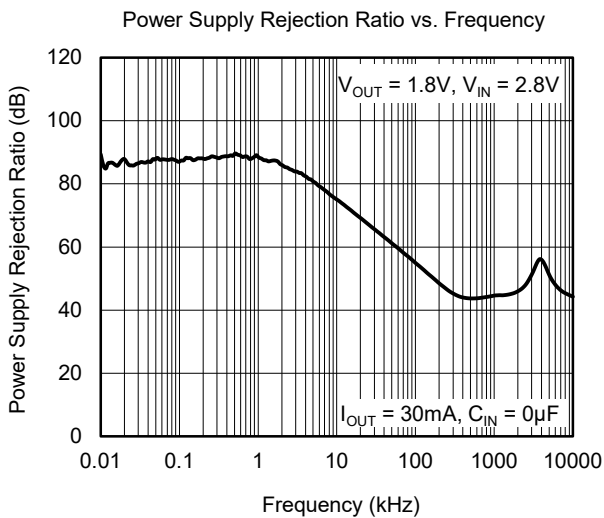
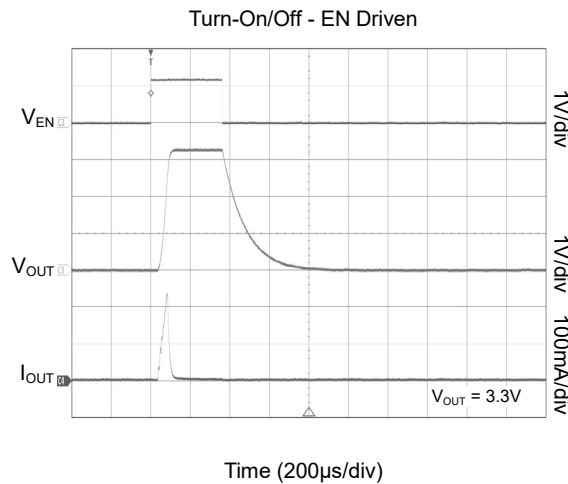
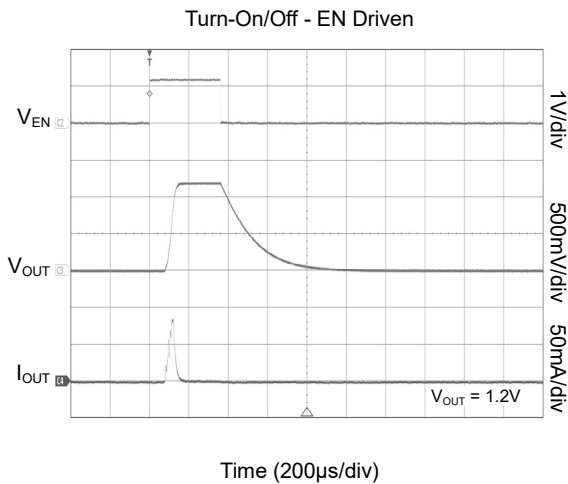
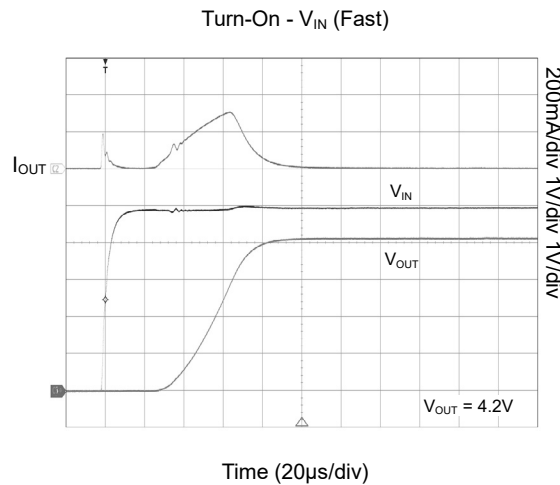
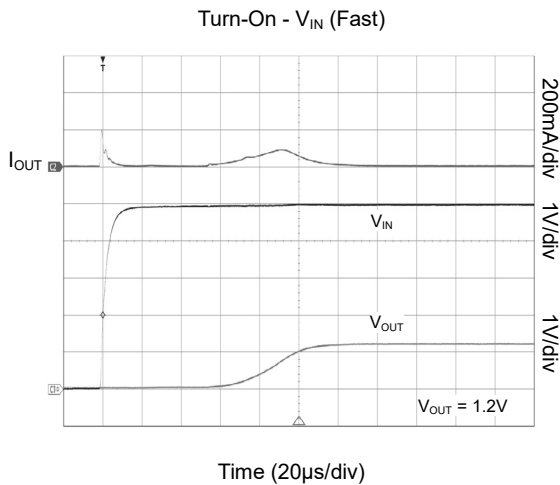

TYPICAL PERFORMANCE CHARACTERISTICS (continued)

$T_J = +25^\circ\text{C}$, $V_{IN} = V_{EN} = (V_{OUT(NOM)} + 0.5\text{V})$ or 1.8V (whichever is greater), $I_{OUT} = 1\text{mA}$, $C_{IN} = C_{OUT} = 2.2\mu\text{F}$, unless otherwise noted.

Output Noise Density vs. Frequency

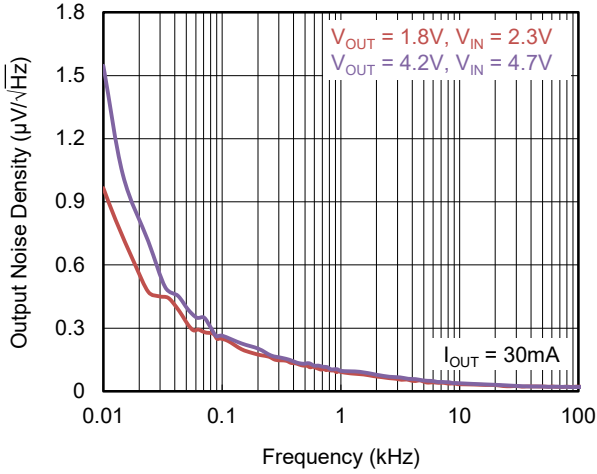

Output Voltage vs. Temperature

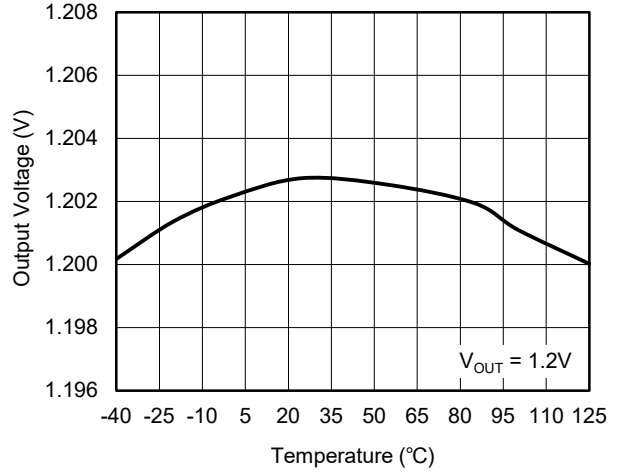

Output Voltage vs. Temperature

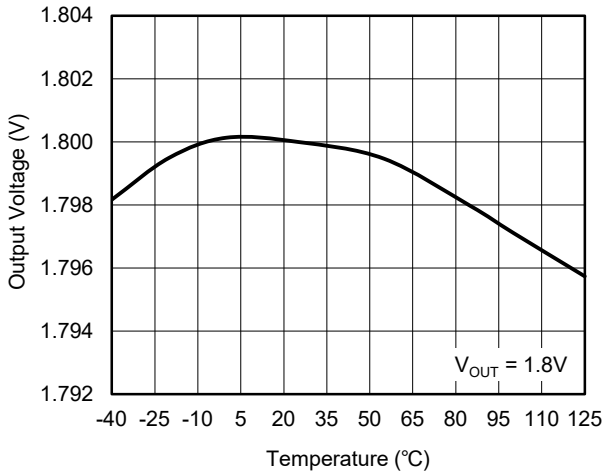

Output Voltage vs. Temperature

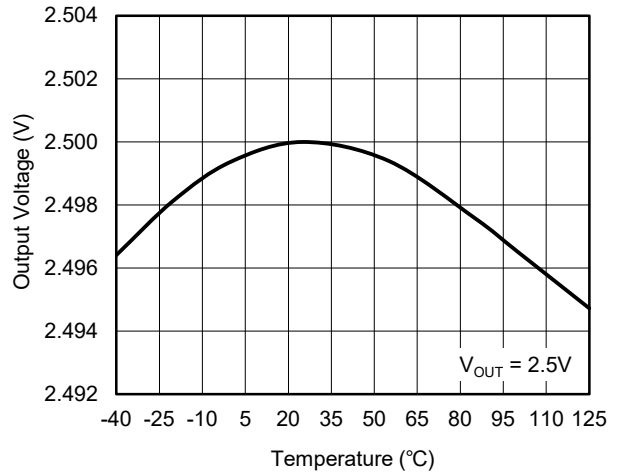

Output Voltage vs. Temperature

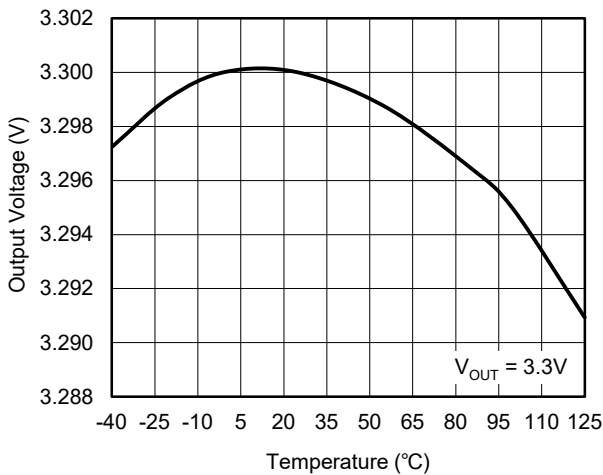

Output Voltage vs. Temperature

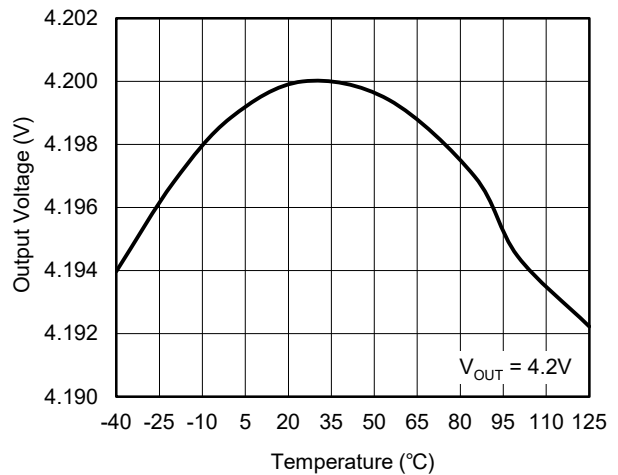

SGM2039 Fast Transient Response, 1A, Low Noise, Low Voltage, Low Dropout Linear Regulator

TYPICAL PERFORMANCE CHARACTERISTICS (continued)

$T_J = +25^\circ\text{C}$, $V_{IN} = V_{EN} = (V_{OUT(NOM)} + 0.5\text{V})$ or 1.8V (whichever is greater), $I_{OUT} = 1\text{mA}$, $C_{IN} = C_{OUT} = 2.2\mu\text{F}$, unless otherwise noted.

Line Regulation vs. Temperature

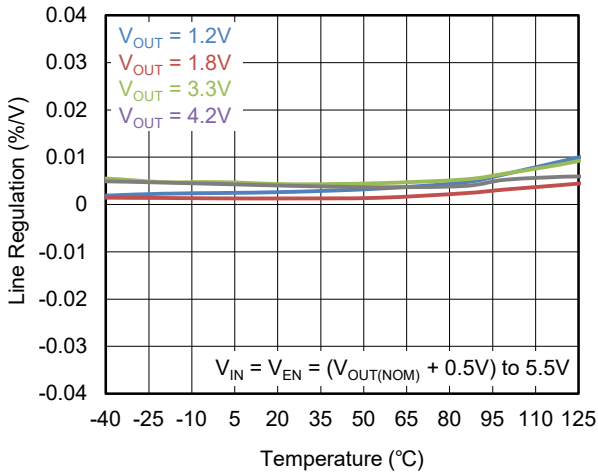

Load Regulation vs. Temperature

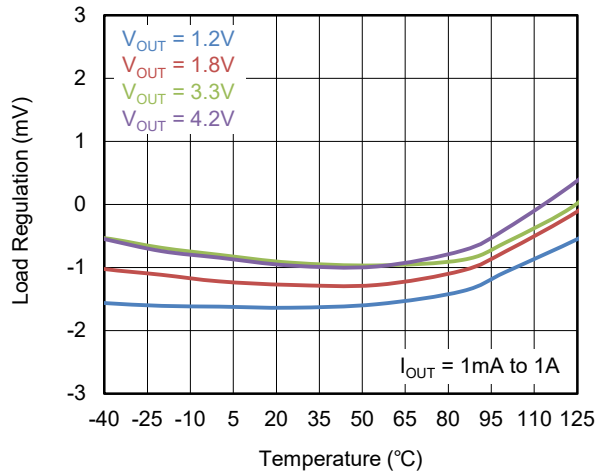

Dropout Voltage vs. Temperature

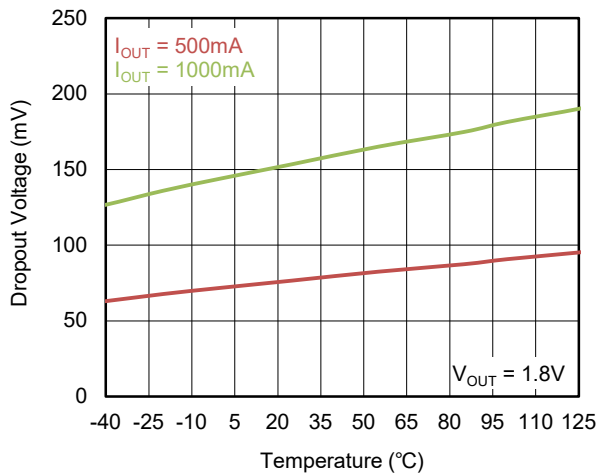

Dropout Voltage vs. Temperature

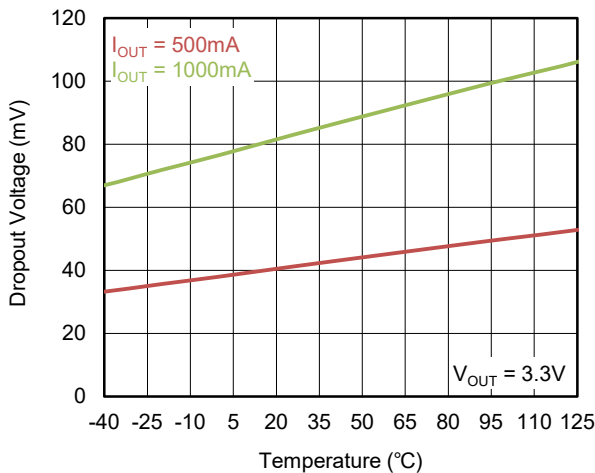

Output Current Limit vs. Temperature

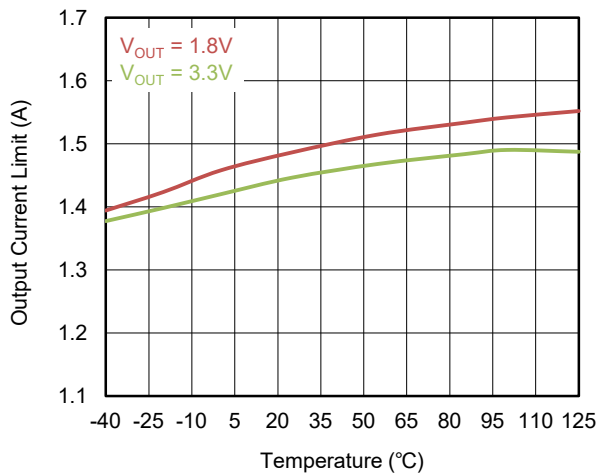

Quiescent Current vs. Temperature

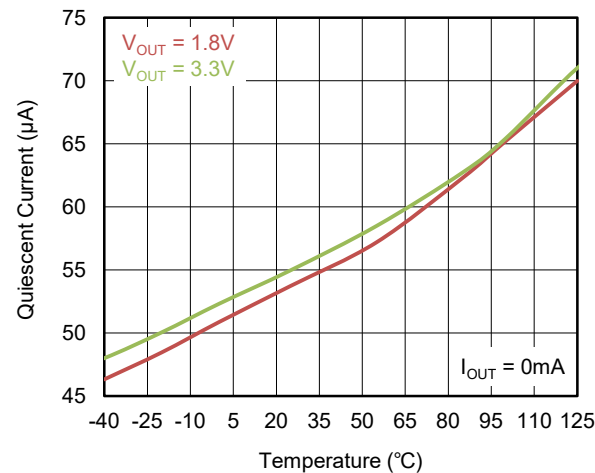

SGM2039 Fast Transient Response, 1A, Low Noise, Low Voltage, Low Dropout Linear Regulator

TYPICAL PERFORMANCE CHARACTERISTICS (continued)

$T_J = +25^\circ\text{C}$, $V_{IN} = V_{EN} = (V_{OUT(NOM)} + 0.5\text{V})$ or 1.8V (whichever is greater), $I_{OUT} = 1\text{mA}$, $C_{IN} = C_{OUT} = 2.2\mu\text{F}$, unless otherwise noted.

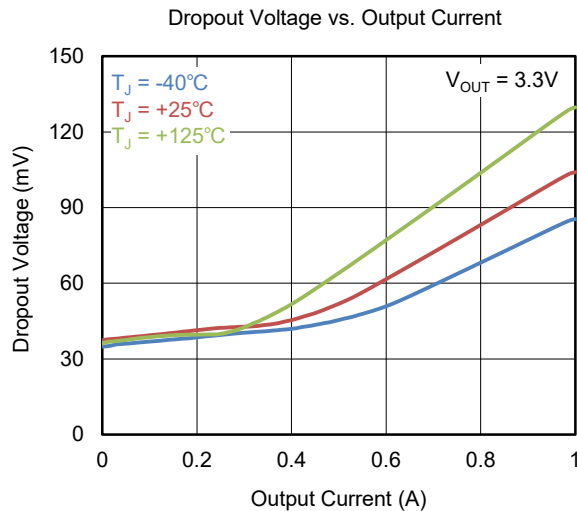
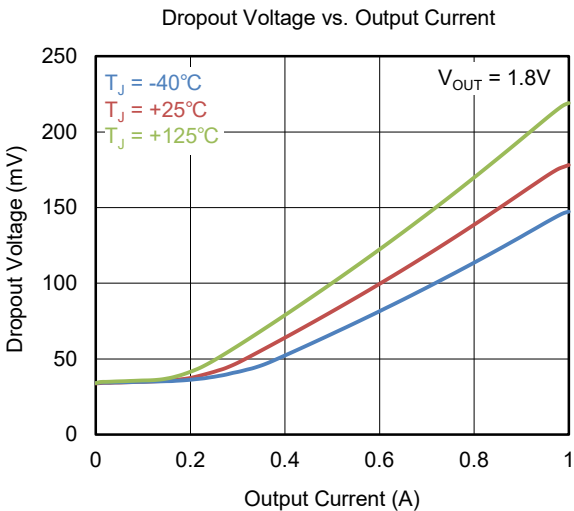
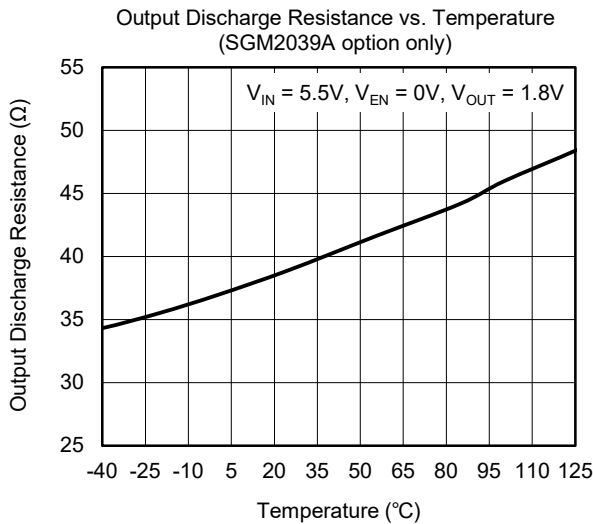
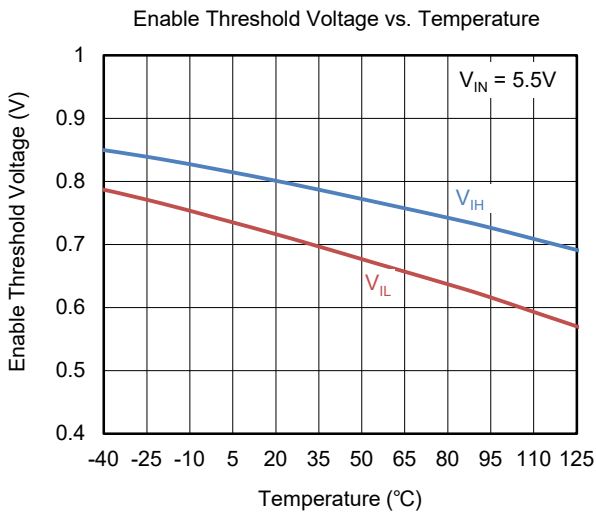
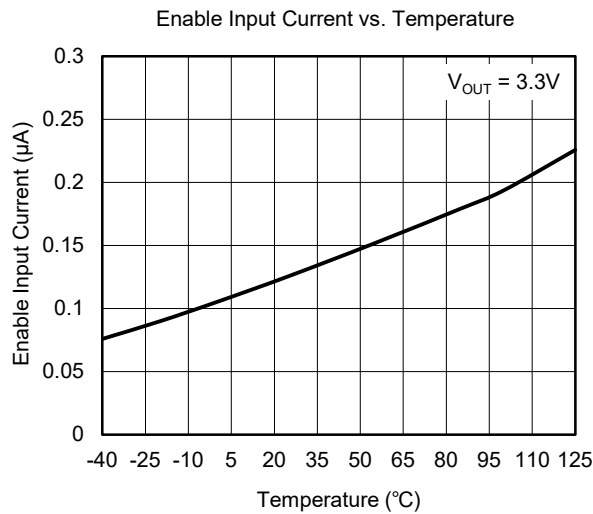
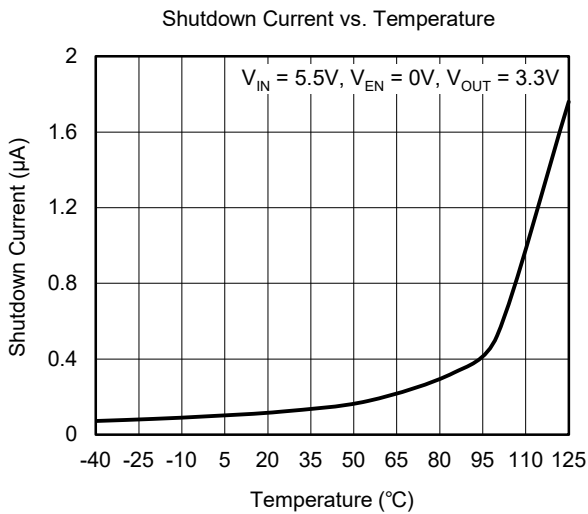

TYPICAL PERFORMANCE CHARACTERISTICS (continued)

$T_J = +25^\circ\text{C}$, $V_{IN} = V_{EN} = (V_{OUT(NOM)} + 0.5\text{V})$ or 1.8V (whichever is greater), $I_{OUT} = 1\text{mA}$, $C_{IN} = C_{OUT} = 2.2\mu\text{F}$, unless otherwise noted.

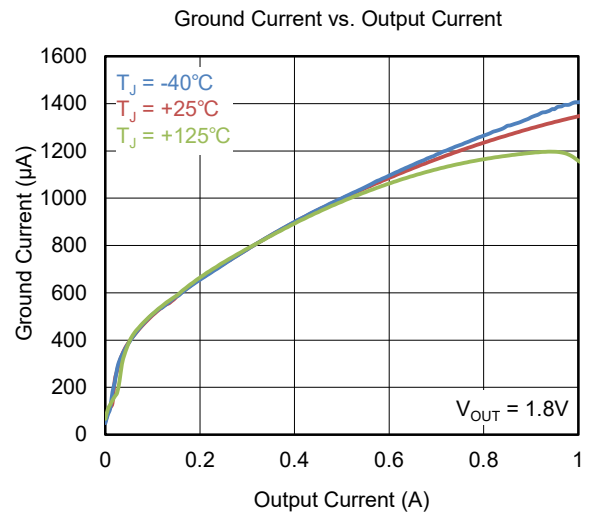
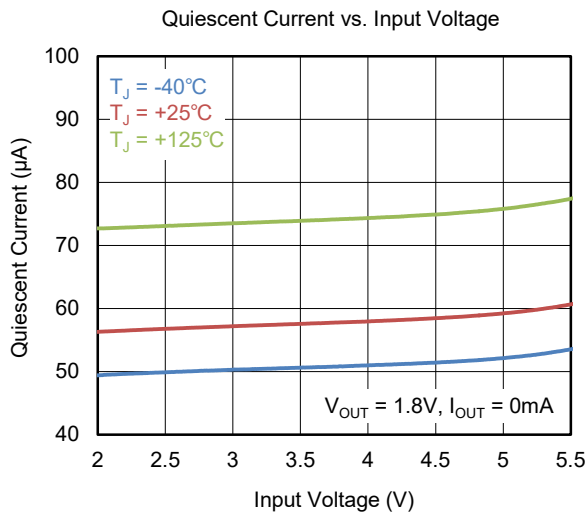

APPLICATION INFORMATION

The SGM2039 is a low noise, fast transient response high performance LDO and provides 1A output current. These features make the device a reliable solution to solve many challenging problems in the generation of clean and accurate power supply. The high performance also makes the SGM2039 useful in a variety of applications. The SGM2039 provides protection functions for output overload, output short-circuit condition and overheating.

The SGM2039 provides an EN pin as an external chip enable control to enable/disable the device. When the regulator is in shutdown state, the shutdown current consumes as low as 0.15 μ A (TYP).

Input Capacitor Selection (C_{IN})

The input decoupling capacitor should be placed as close as possible to the IN pin for ensuring the device stability. 1 μ F or larger X7R or X5R ceramic capacitor is selected to get good dynamic performance.

Output Capacitor Selection (C_{OUT})

The output capacitor should be placed as close as possible to the OUT pin. 2.2 μ F or larger X7R or X5R ceramic capacitor is selected to get good dynamic performance. The minimum effective capacitance of C_{OUT} that SGM2039 can remain stable is 1.5 μ F. For ceramic capacitor, temperature, DC bias and package size will change the effective capacitance, so enough margin of C_{OUT} must be considered in design. Additionally, C_{OUT} with larger capacitance and lower ESR will help increase the high frequency PSRR and improve the load transient response.

Adjustable Regulator

The output voltage of the SGM2039A/B-ADJ can be adjusted from 0.8V to 4.2V. The ADJ pin will be connected to two external resistors as shown in Figure 6, the output voltage is determined by the following equation:

$$V_{OUT} = V_{ADJ} \times \left(1 + \frac{R_1}{R_2} \right) \quad (1)$$

where:

V_{OUT} is output voltage and V_{REF} is the adjustable reference voltage, $V_{ADJ} = 0.8V$.

One parallel capacitor (C_{FF}) with R_1 can be used to improve the feedback loop stability and PSRR, increase the transient response and reduce the output noise. R_1 and R_2 can be calculated for any output voltage range using Equation 1. Choose $R_2 \leq 16k\Omega$ to maintain a 50 μ A minimum load.

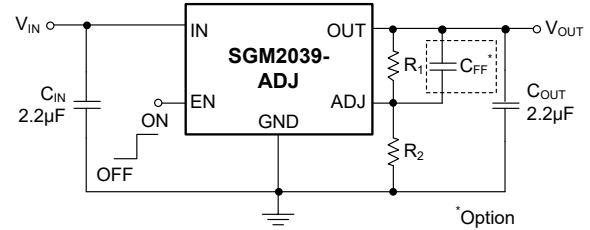

Figure 6. Adjustable Output Voltage Application

Enable Operation

The EN pin of the SGM2039 is used to enable/disable the device and to deactivate/activate the output automatic discharge function (SGM2039A only).

When the EN pin voltage is lower than 0.4V, the device is in shutdown state. There is no current flowing from IN to OUT pins. In this state, the automatic discharge transistor is active to discharge the output voltage through a 38 Ω (TYP) resistor.

When the EN pin voltage is higher than 1.0V, the device is in active state. The output voltage is regulated to the expected value and the automatic discharge transistor is turned off.

The EN pin is pulled down by an internal 120nA (TYP) current source when the EN pin is floated. This current source will ensure the SGM2039 in shutdown state and reduce the power dissipation in system.

Reverse Current Protection

The PMOS power transistor has an inherent body diode. This body diode will be forward biased when $V_{OUT} > V_{IN}$. When $V_{OUT} > V_{IN}$, the reverse current flowing from the OUT pin to the IN pin will damage the SGM2039. If $V_{OUT} > V_{IN}$ event would happen in system, one external diode will be added between OUT pin and IN pin in circuit design to protect the SGM2039.

Output Current Limit and Short-Circuit Protection

When overload events happen, the output current is internally limited to 1.45A (TYP). When the OUT pin is shorted to ground, the short-circuit protection will limit the output current to 1.45A (TYP).

Thermal Shutdown

The SGM2039 can detect the temperature of die. When the die temperature exceeds the threshold value of thermal shutdown, the SGM2039 will be in shutdown state and it will remain in this state until the die temperature decreases to +145 $^{\circ}$ C.

REVISION HISTORY

NOTE: Page numbers for previous revisions may differ from page numbers in the current version.

Changes from Original (DECEMBER 2022) to REV.A	Page
Changed from product preview to production data.....	All

PACKAGE INFORMATION

PACKAGE OUTLINE DIMENSIONS

XTDFN-1.6x1.2-8L

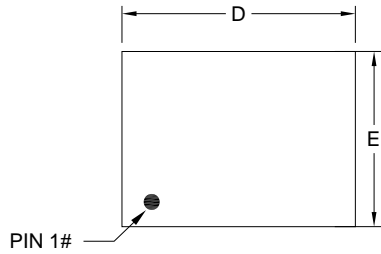

TOP VIEW

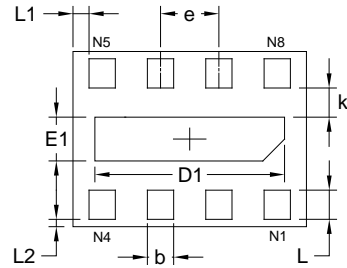

BOTTOM VIEW

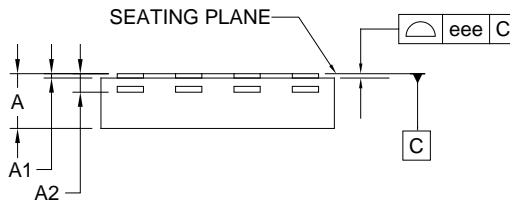

SIDE VIEW

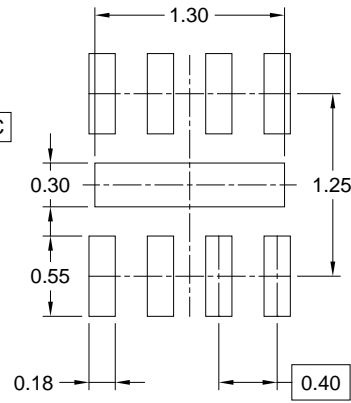

RECOMMENDED LAND PATTERN (Unit: mm)

Symbol	Dimensions In Millimeters		
	MIN	MOD	MAX
A	0.340	-	0.400
A1	0.000	-	0.050
A2	0.127 REF		
D	1.500	1.600	1.700
E	1.100	1.200	1.300
D1	1.250	1.300	1.350
E1	0.250	0.300	0.350
b	0.130	0.180	0.230
e	0.400 BSC		
L	0.150	0.200	0.250
L1	0.110 REF		
L2	0.050 REF		
k	0.150	0.200	0.250
eee	0.050		

NOTE: This drawing is subject to change without notice.

PACKAGE INFORMATION

TAPE AND REEL INFORMATION

REEL DIMENSIONS

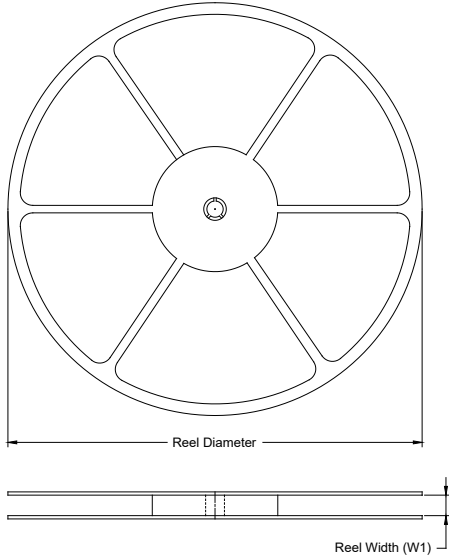

TAPE DIMENSIONS

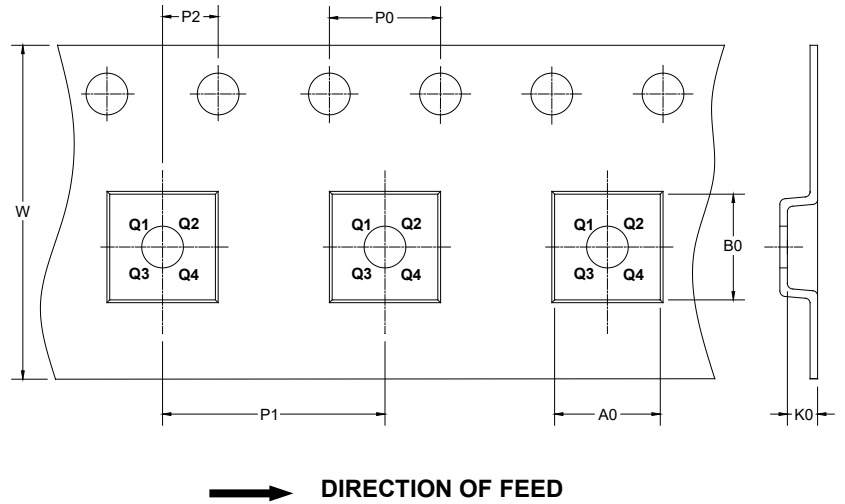

NOTE: The picture is only for reference. Please make the object as the standard.

KEY PARAMETER LIST OF TAPE AND REEL

Package Type	Reel Diameter	Reel Width W1 (mm)	A0 (mm)	B0 (mm)	K0 (mm)	P0 (mm)	P1 (mm)	P2 (mm)	W (mm)	Pin1 Quadrant
XTDFN-1.6×1.2-8L	7"	9.5	1.37	1.77	0.55	4.0	4.0	2.0	8.0	Q1

000001

PACKAGE INFORMATION

CARTON BOX DIMENSIONS



NOTE: The picture is only for reference. Please make the object as the standard.

KEY PARAMETER LIST OF CARTON BOX

Reel Type	Length (mm)	Width (mm)	Height (mm)	Pizza/Carton
7" (Option)	368	227	224	8
7"	442	410	224	18

DD0002