

客户 (Customer) : _____

承认书

Approval Sheet



谨致执事者：兹提供敝公司之有关详细规格及图面数据,敬请给予办理试认定手续。
同时敬请送返一份附有贵公司签认之测试认定后之样品承认书。

We are pleased in sending you herewith on specification and drawings for your approval.
Please return to us one copy "Approval sheet" with your approved signature.

型号 (Model No.) : A-SP194XW1D-C01-4T

发文日期 (Issue Date) : 2020/12/09 承认日期 (Approved Date) : _____

Checking signature of Amicc

Designer	Checker	Approver
		

Approval signature of customer

Designer	Checker	Approver

江苏欧密格光电科技股份有限公司

Jiangsu Amicc Opto-Electronics Technology Co.,Ltd

地址:江苏省常州市湖塘鸣凰沟南工业区武南中路 98 号

Add: 98.Wu Nan middle road.Gounan Industrial Park Changzhou

TEL:0086-519-89806999

FAX:0086-519-86523668

EMAIL:AMICC@AMICC.COM

Mono-Color Type ■ Top view 0603 Package A-SP194XW1D-C01-4T



Features

- 0603 package
- Top view LED
- Compatible with infrared and vapor phase reflow solder process.
- Wide viewing angle
- Pb-free
- RoHS compliant

Description

The Amicc 194X package has high efficacy, high power consumption, wide viewing angle and a compact form factor. These features make this package an ideal LED for all lighting applications.

Applications

- General lighting
- Decorative and Entertainment Lighting
- Indicators
- Automotive Telecommunication
- Switch lights

Device Selection Guide

Chip Materials	Emitted Color	Resin Color
GaN/InGaN	White	Yellow Diffused

Absolute Maximum Ratings (T_{Soldering}=25°C)

Parameter	Symbol	Rating	Unit
Forward Current	I _F	25	mA
Peak Forward Current (Duty 1/10 @1ms)	I _{FP}	60	mA
Power Dissipation	P _d	95	mW
Operating Temperature	T _{opr}	-40 ~ +85	°C
Storage Temperature	T _{stg}	-40 ~ +100	°C
Electrostatic Discharge(HBM)	ESD	1000	V
Soldering Temperature	T _{sol}	Reflow Soldering : 260 °C for 10 sec. Hand Soldering : 350 °C for 3 sec.	

Note:
 The products are sensitive to static electricity and must be carefully taken when handling products.

Electro-Optical Characteristics (T_{Soldering}=25°C)

Parameter	Symbol	Min.	Typ.	Max.	Unit	Condition
Luminous Intensity	I _v	140	-----	285	mcd	I _F =5mA
Forward Voltage	V _F	2.65	-----	3.10	V	I _F =5mA
Viewing Angle	2θ _{1/2}	-----	130	-----	deg	I _F =5mA
Reverse Current	I _R	-----	-----	1	μA	V _R =7V

Notes:
 1. Tolerance of Luminous Intensity ±10%.
 2. Tolerance of Forward Voltage : ± 0.05V.

Bin Range of Luminous Intensity

Bin Code	Min.	Max.	Unit	Condition
AR2	140	180	mcd	I _F =5mA
AS1	180	225		
AS2	225	285		

Note:
Tolerance of Luminous Intensity: ±10%.

Bin Range of Forward Voltage

Bin Code	Min.	Max.	Unit	Condition
1	2.65	2.70	V	I _F =5mA
2	2.70	2.75		
3	2.75	2.80		
4	2.80	2.85		
5	2.85	2.90		
6	2.90	2.95		
7	2.95	3.00		
8	3.00	3.05		
9	3.05	3.10		

Note:
Tolerance of Forward Voltage: ± 0.05V.

Bin Range of Chromaticity Coordinates

Bin Code	CIE_x	CIE_y	Bin Code	CIE_x	CIE_y
A1	0.2860	0.2497	B1	0.2994	0.2777
	0.2860	0.2823		0.2994	0.3103
	0.2994	0.3103		0.3128	0.3383
	0.2994	0.2777		0.3128	0.3057

Note:

1. The value is based on driving current by 5mA.
2. Tolerance of Chromaticity Coordinates: ± 0.005

The C.I.E. 1931 Chromaticity Diagram

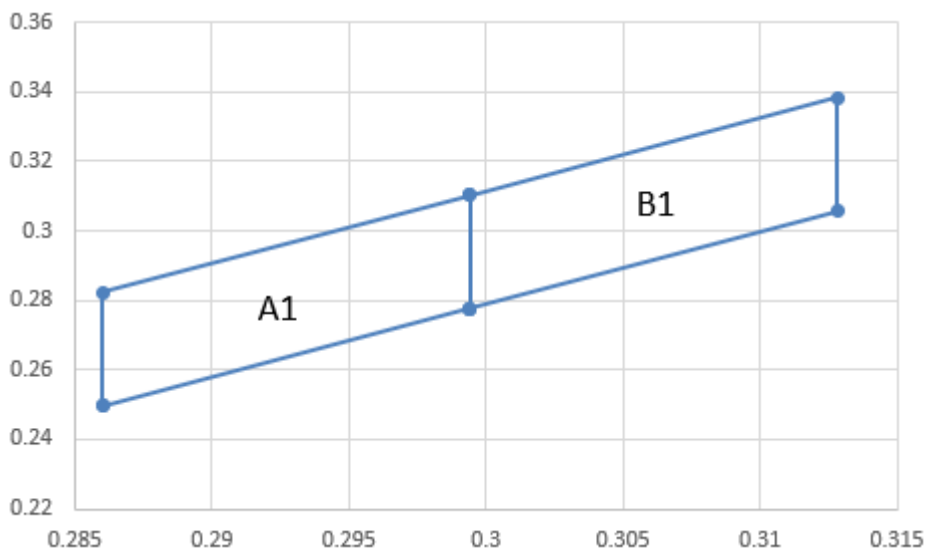

Spectrum Distribution

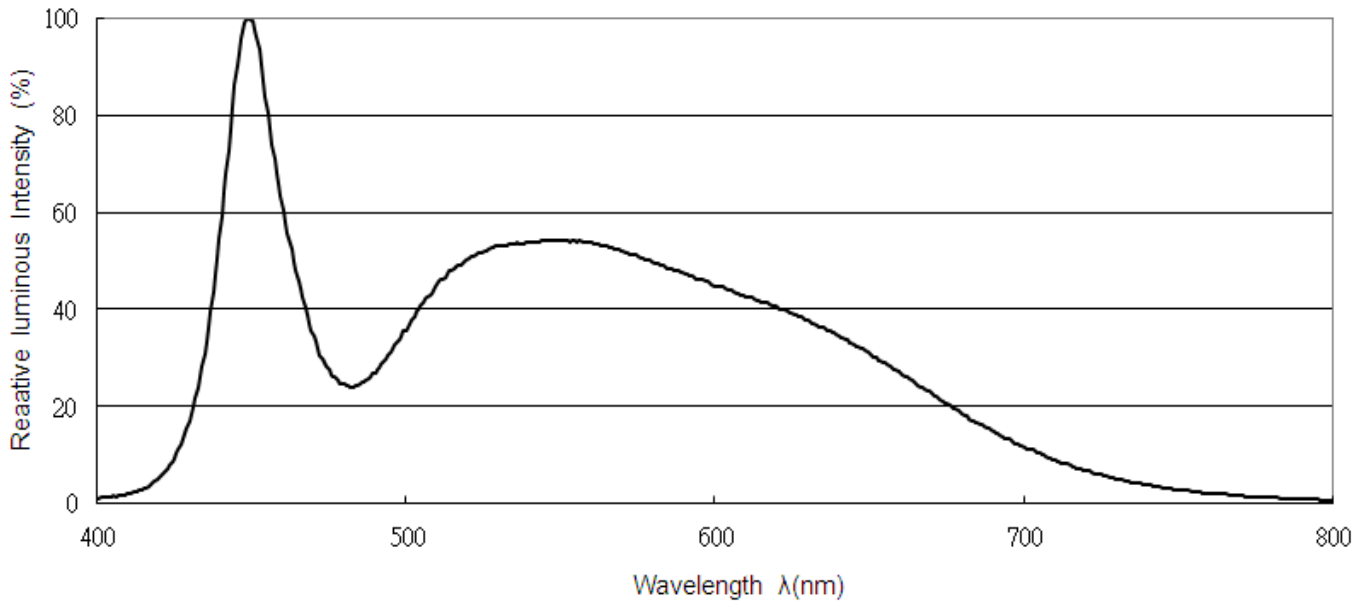

Typical Electro-Optical Characteristics Curves

Fig.1 - Forward Voltage Shift vs. Junction Temperature

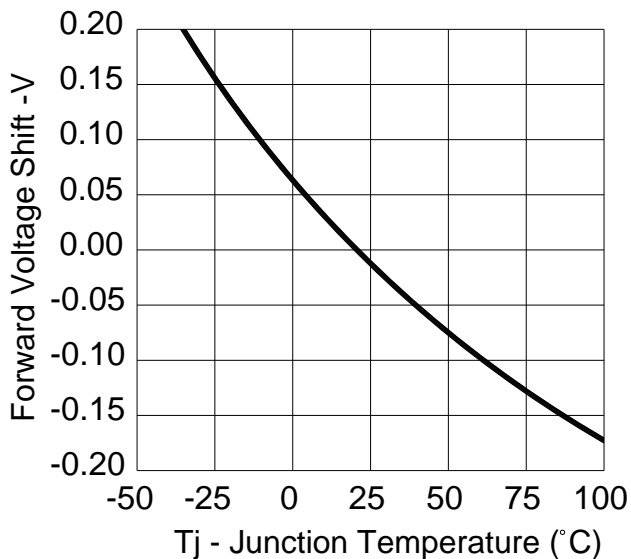
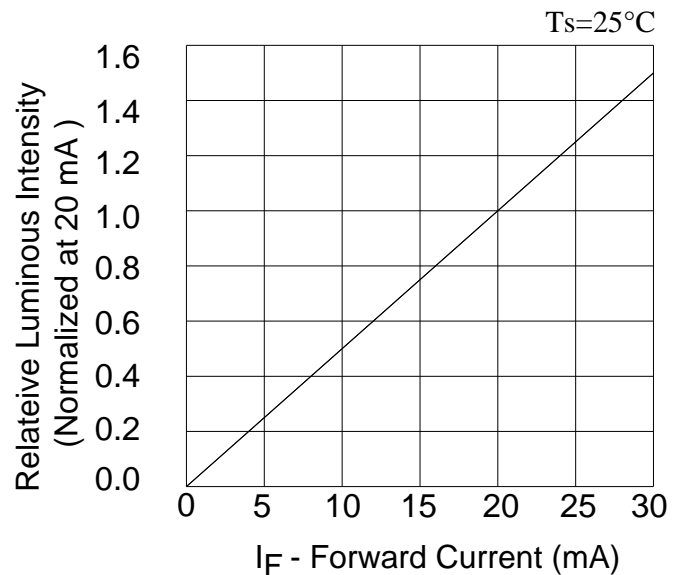

Fig.2 - Relative Luminous Intensity vs. Forward Current



Typical Electro-Optical Characteristics Curves

Fig.3-Relative Luminous Intensity vs.Juntion Temperature

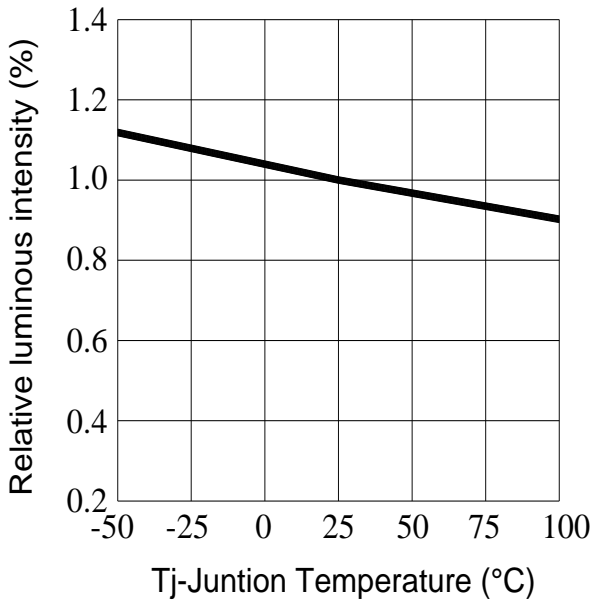

Fig.4-Forward Current vs. Forward Voltage $T_a=25^\circ\text{C}$

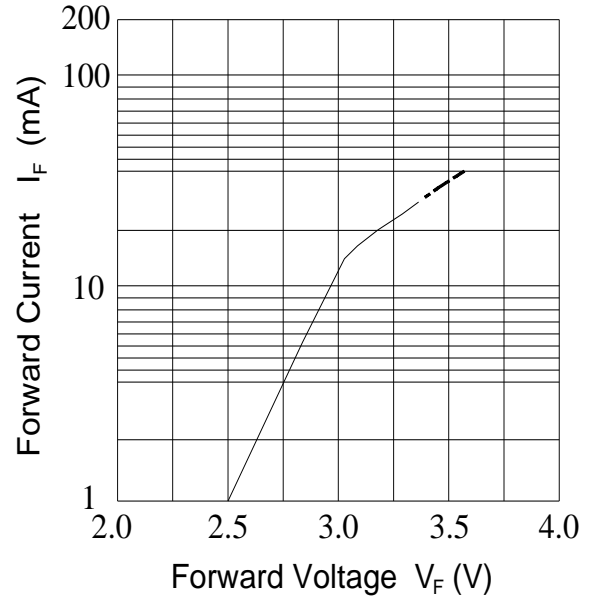

Fig.5-Max.Driving Forward Current vs.Soldering Temperature

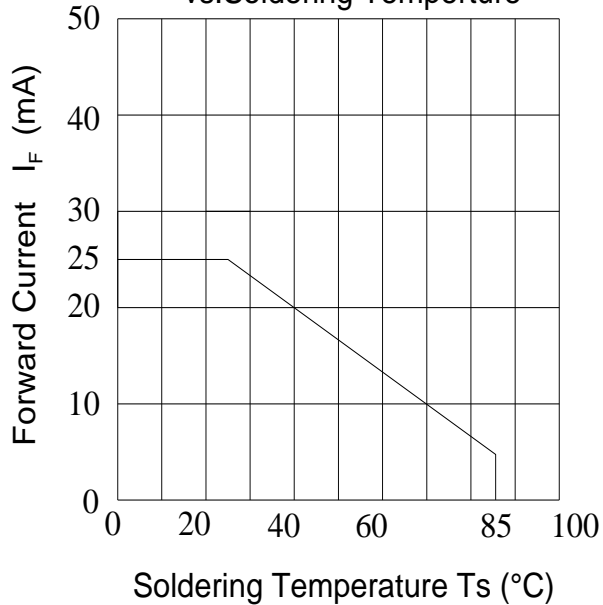
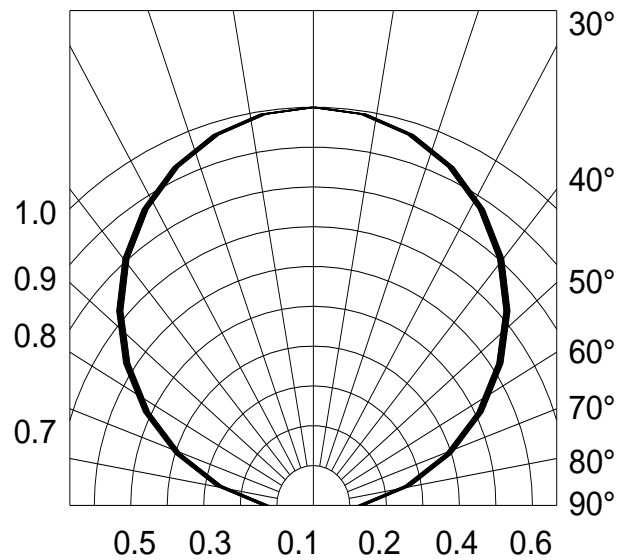
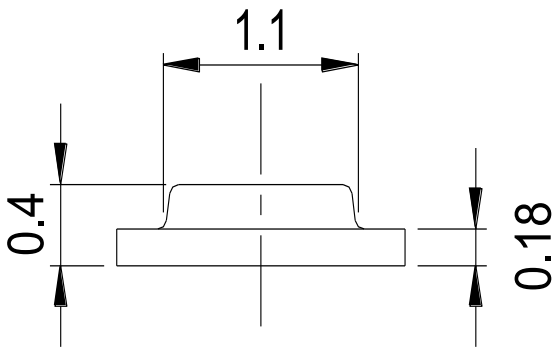
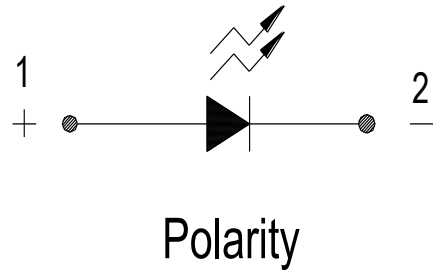
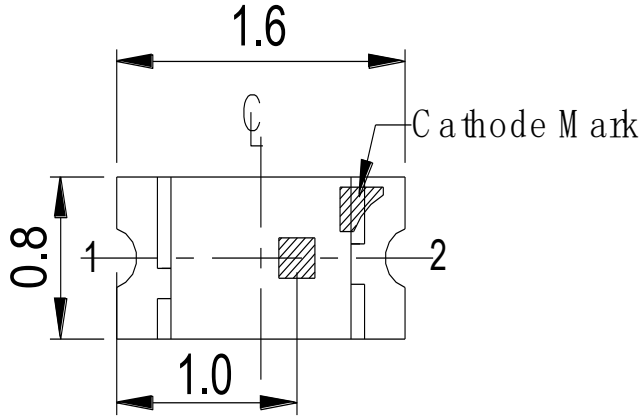

Fig.6-Radiation Diagram $T_a=25^\circ\text{C}$



Package Dimension



Recommended Solder Pad

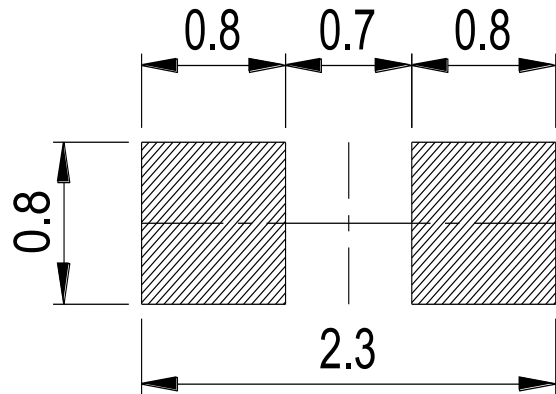
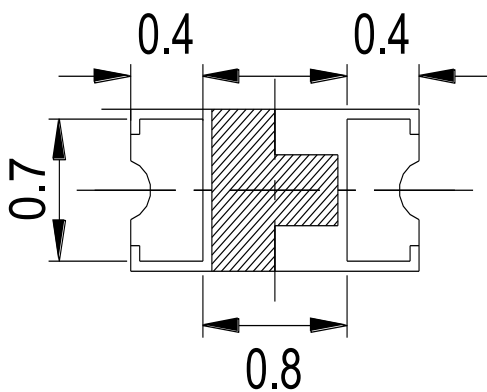

Note:
Tolerance unless mentioned is ± 0.1 mm, Unit = mm.

Moisture Resistant Packing Materials

Label Explanation

批号 : EM S L 12 09 0110
 A B C D E F

- A---EM: Emos Code
- B---S:SMD
- L---Local
- D---Year
- E---Month
- F---SPEC.



Reel Dimensions

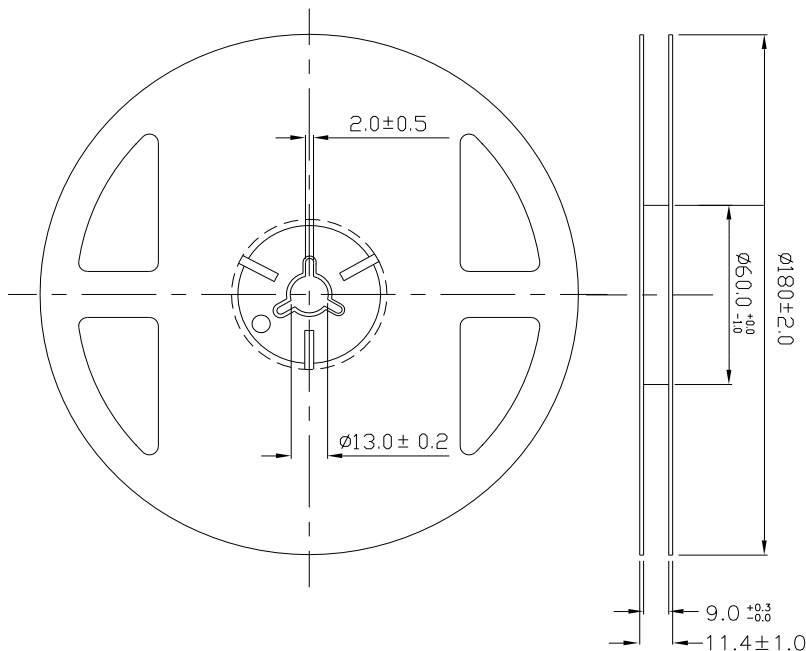

Note:
 Tolerances unless mentioned ± 0.1 mm, Unit = mm.

Carrier Tape Dimensions: Loaded Quantity 4000 pcs Per Reel

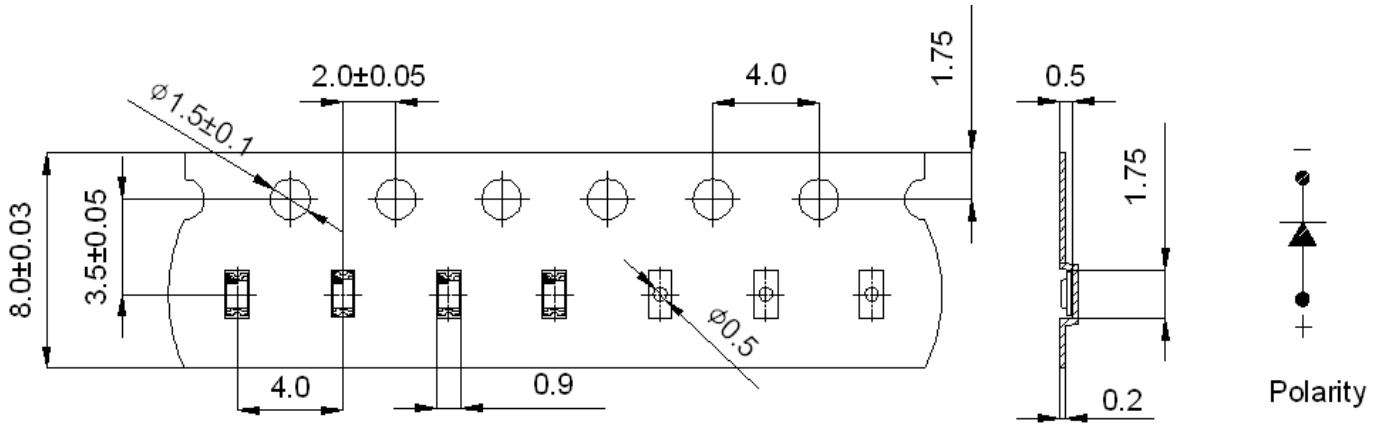

Note:
 Tolerance unless mentioned is ± 0.1 mm, Unit = mm.

Moisture Resistant Packing Process

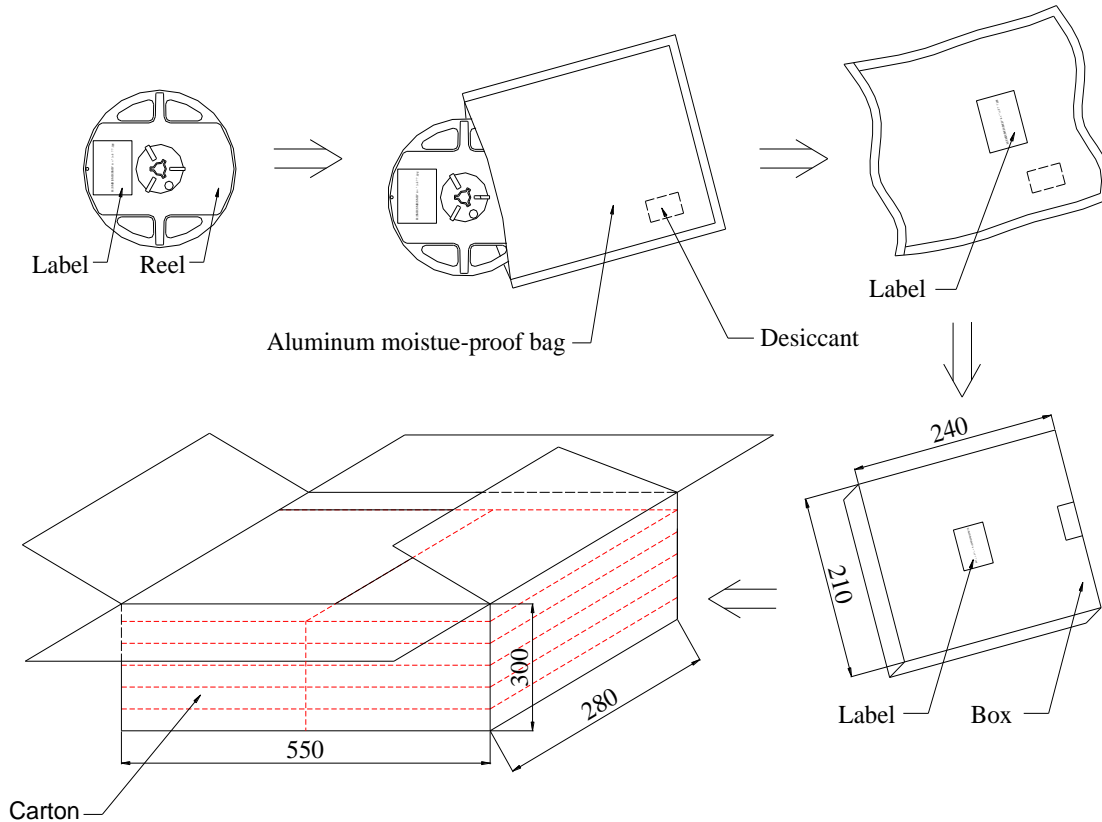

Reliability Test Items and Conditions

The reliability of products shall be satisfied with items listed below.

Confidence level : 90%

LTPD : 10%

No.	Items	Test Condition	Test Hours/Cycles	Sample Size	Ac/Re
1	Reflow Soldering	Temp. : 260°C/10sec.	6 Min.	22 PCS.	0/1
2	Thermal Shock	H : +100°C 5min ∫ 10 sec L : -10°C 5min	300 Cycles	22 PCS.	0/1
3	Temperature Cycle	H : +100°C 15min ∫ 5 min L : -40°C 15min	300 Cycles	22 PCS.	0/1
4	High Temperature/Humidity Reverse Bias	Ta=85°C,85%RH	1000 Hrs.	22 PCS.	0/1
5	Low Temperature Storage	Ta=-40°C	1000 Hrs.	22 PCS.	0/1
6	High Temperature Storage	Ta=100°C	1000 Hrs.	22 PCS.	0/1
7	DC Operation Life	Ta=25°C, I _F = 5 mA	1000 Hrs.	22 PCS.	0/1

Precautions for Use

1. Over-current-proof

Customer must apply resistors for protection; otherwise slight voltage shift will cause big current change (Burn out will happen).

2. Storage

2.1 Do not open moisture proof bag before the products are ready to use.

2.2 Before opening the package: The LEDs should be kept at 30°C or less and 90%RH or less.

2.3 After opening the package: The LED's floor life is 1 year under 30°C or less and 60% RH or less. If unused LEDs remain, it should be stored in moisture proof packages.

2.4 If the moisture absorbent material (silica gel) has faded away or the LEDs have exceeded the storage time, baking treatment should be performed using the following conditions.

Baking treatment: 60±5°C for 24 hours.

3. Soldering Condition

3.1 Pb-free solder temperature profile

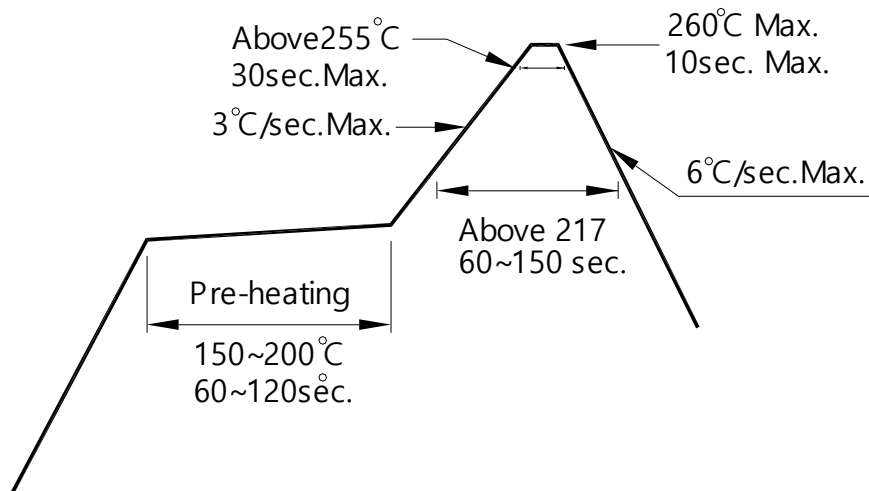

3.2 Reflow soldering should not be done more than two times.

3.3 When soldering, do not put stress on the LEDs during heating.

3.4 After soldering, do not warp the circuit board.

4. Soldering Iron

Each terminal is to go to the tip of soldering iron temperature less than 350°C for 3 seconds within once in less than the soldering iron capacity 25W. Leave two seconds and more intervals, and do soldering of each terminal. Be careful because the damage of the product is often started at the time of the hand solder.

5. Repairing

Repair should not be done after the LEDs have been soldered. When repairing is unavoidable, a double-head soldering iron should be used (as below figure). It should be confirmed beforehand whether the characteristics of the LEDs will or will not be damaged by repairing.