



TAI-SAW TECHNOLOGY CO., LTD.

No. 3, Industrial 2nd Rd., Ping-Chen Industrial District,
Taoyuan, 324, Taiwan, R.O.C.

TEL: 886-3-4690038 FAX: 886-3-4697532

E-mail: tstsales@mail.taisaw.com Web: www.taisaw.com

Product Specifications Approval Sheet

Product Description: SAW DPX 1950 / 2140 MHz Band 1 SMD 1.8X1.4 mm (BW=60 MHz)

TST Part No.: TF0126DA

Customer Part No.: _____

Customer signature required
Company: _____
Division: _____
Approved by : _____
Date: _____

Checked by: _____ Anne Chen 

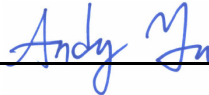
Approved by: _____ Andy Yu 

Date: _____ 11 / 08 / 2017

1. Customer signed back is required before TST can proceed with sample build and receive orders.
2. Orders received without customer signed back will be regarded as agreement on the specifications.
3. Any specifications changes must be approved upon by both parties and a new revision of specifications shall be released to reflect the change



TAI-SAW TECHNOLOGY CO., LTD.

No. 3, Industrial 2nd Rd., Ping-Chen Industrial District,
Taoyuan, 324, Taiwan, R.O.C.

TEL: 886-3-4690038 FAX: 886-3-4697532

E-mail: tstsales@mail.taisaw.com Web: www.taisaw.com

SAW DPX 1950 / 2140 MHz Band 1 SMD 1.8X1.4 mm (BW=60 MHz)

MODEL NO.:TF0126DA

REV.1.0

A. MAXIMUM RATING:

1. Operating temperature range: -20 °C to +85 °C
2. Storage temperature range: -40 °C to +85 °C
3. Tx Input power : 29dBm (Ta=+50°C,50000h,CW)
- 3.1Rx Input power : 15dBm
4. Maximum DC Voltage: 0 V
5. Moisture Sensitivity Level: Level 3 (MSL 3)
6. ESD 50V(MM) 100V(HBM)

RoHS Compliant
Lead free
Lead-free soldering

Electrostatic Sensitive Device (ESD)

B. ELECTRICAL CHARACTERISTICS:

Terminating impedance (Tx Port): 50 Ω (unbalanced)

Terminating impedance (Rx Port): 100Ω//11nH(balanced)

Terminating impedance (Ant Port): 50 Ω//2.5nH (unbalanced)

Tx to ANT (f_{T0}=1950 MHz)

Parameters Description		Unit	Min	Typ	Max	Remarks
Insertion Loss	1920 ~ 1980 MHz	dB	-	1.7	2.3	
Amplitude ripple	1920 ~ 1980 MHz	dB	-	0.4	1.3	(Over any 5MHz in-band)
VSWR	ANT		-	1.5	2.0	
	Tx		-	1.7	2.0	
Attenuation:						
824.00 ~ 849.00 MHz		dB	40	47		
869.00 ~ 894.00 MHz		dB	40	46		
880.00 ~ 915.00 MHz		dB	40	46		
925.00 ~ 960.00 MHz		dB	40	45		
1565.42 ~ 1605.88 MHz		dB	35	39		
1805.00 ~ 1880.00 MHz		dB	20	38		
2010.00 ~ 2025.00 MHz		dB	10	20		
2110.00 ~ 2170.00 MHz		dB	40	45		
2400.00 ~ 2500.00 MHz		dB	30	43		
3840.00 ~ 3960.00 MHz		dB	30	37		
4900.00 ~ 5950.00 MHz		dB	16	24		

ANT to Rx (f_{T0}=2140 MHz)

Parameters Description		Unit	Min	Typ	Max	Remarks
Insertion Loss	2110 ~ 2170 MHz	dB	-	2.2	2.6	
Amplitude ripple	2110 ~ 2170 MHz	dB		0.6	1.2	(Over any 5MHz in-band)
Phase Balance	2110 ~ 2170 MHz	deg	-20	-11/1.5	20	
Amplitude Balance	2110 ~ 2170 MHz	dB	-2	0.1/1	2.0	
VSWR	ANT	2110 ~ 2170 MHz	-	1.5	2.0	
	Rx			1.9	2.3	
Attenuation:						
824.00 ~ 849.00 MHz		dB	45	69		
880.00 ~ 915.00 MHz		dB	45	68		
1710.00 ~ 1785.00 MHz		dB	40	47		
1920.00 ~ 1980.00 MHz		dB	44	47		
1980.00 ~ 2025.00 MHz		dB	25	43		
2400.00 ~ 2500.00 MHz		dB	30	40		
4900.00 ~ 5950.00 MHz		dB	35	45		

Tx to Rx

Isolation	1920.00~1980.00 MHz	dB	50	54	-	
	2110.00~2170.00 MHz	dB	50	52	-	

Notes : (1) With Matching Network

C. FREQUENCY CHARACTERISTICS:

Tx to Ant

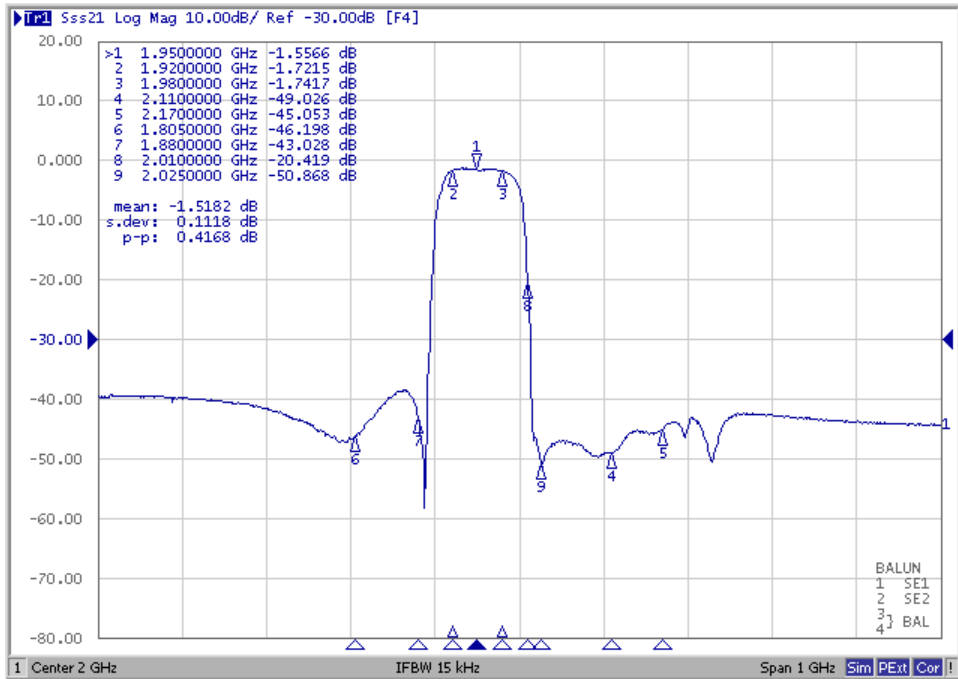

Ant to Rx

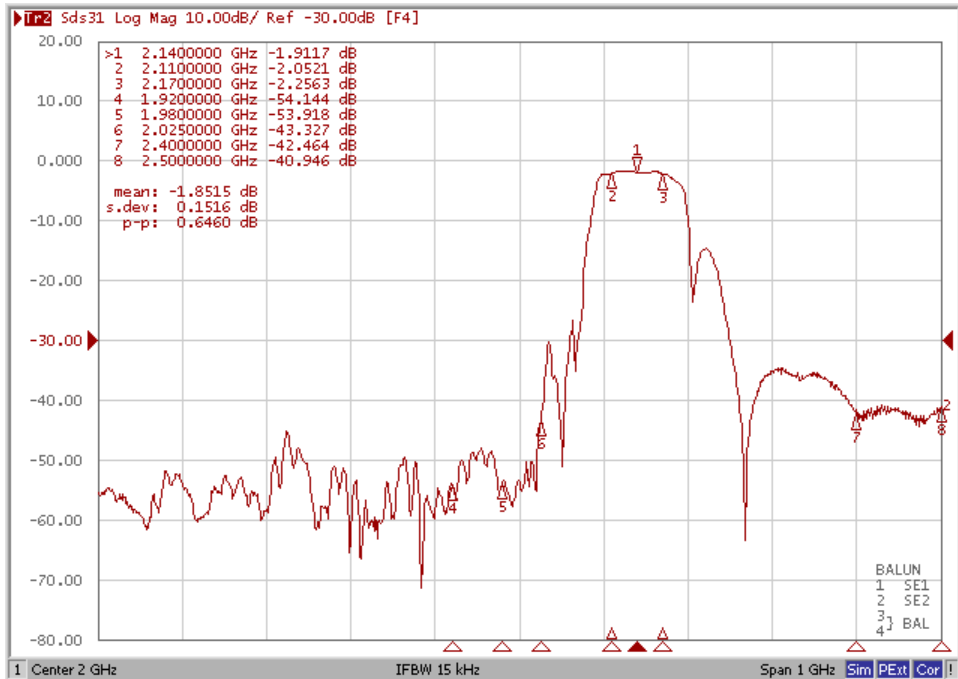

Ripple Deviation

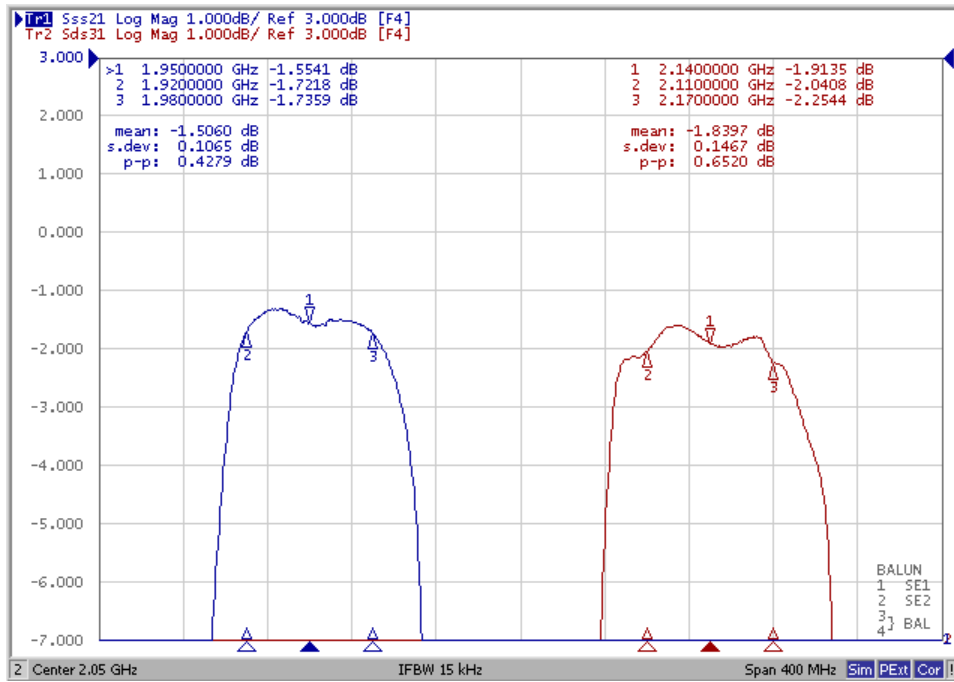

Isolation

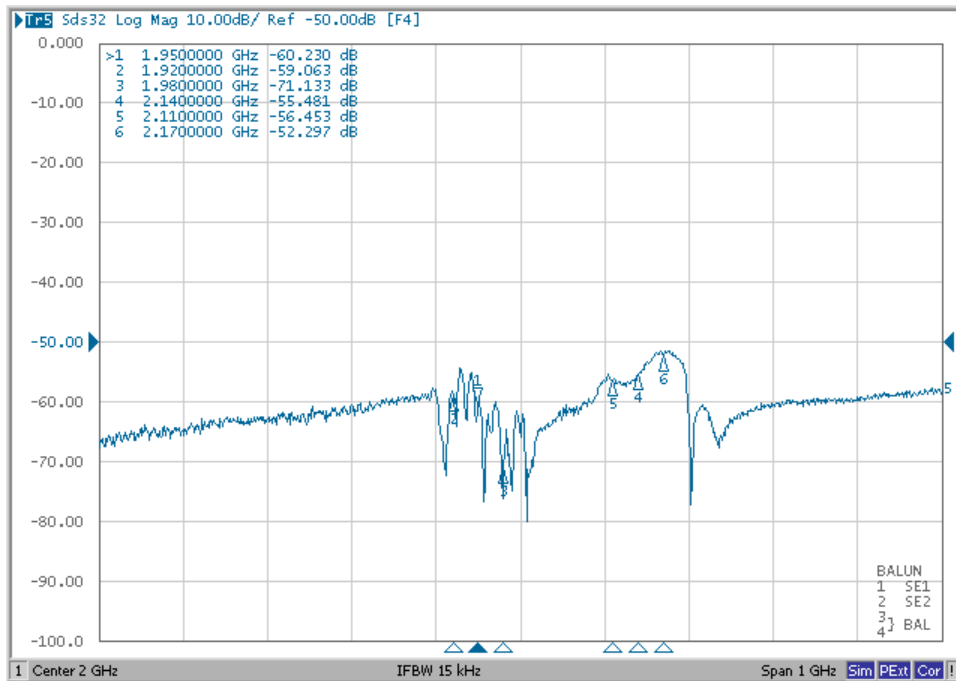

VSWR (Tx Port)

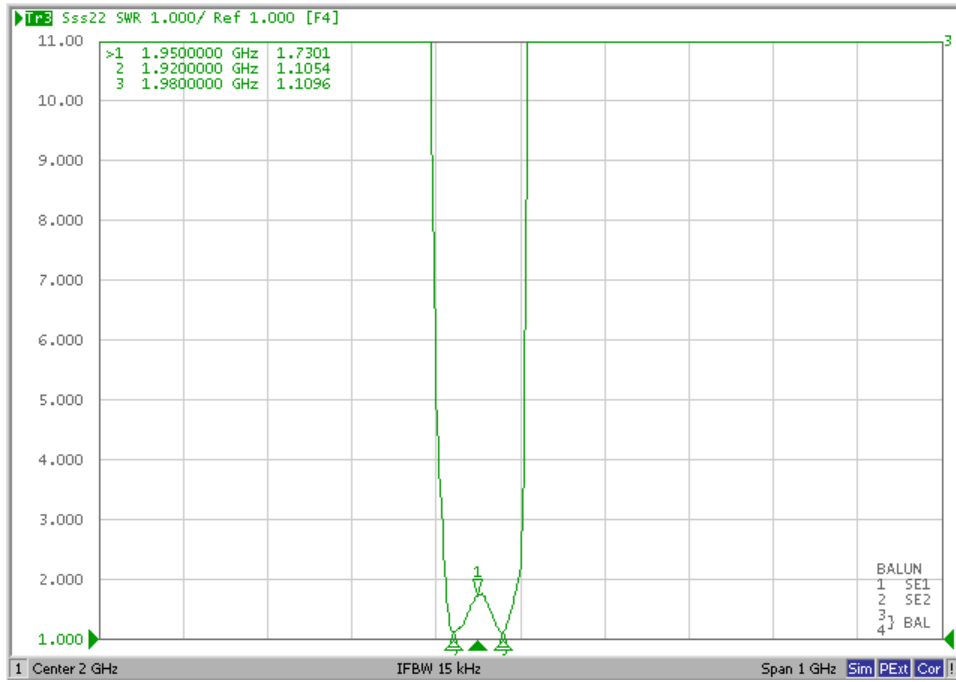

Smith Chart (Tx Port)

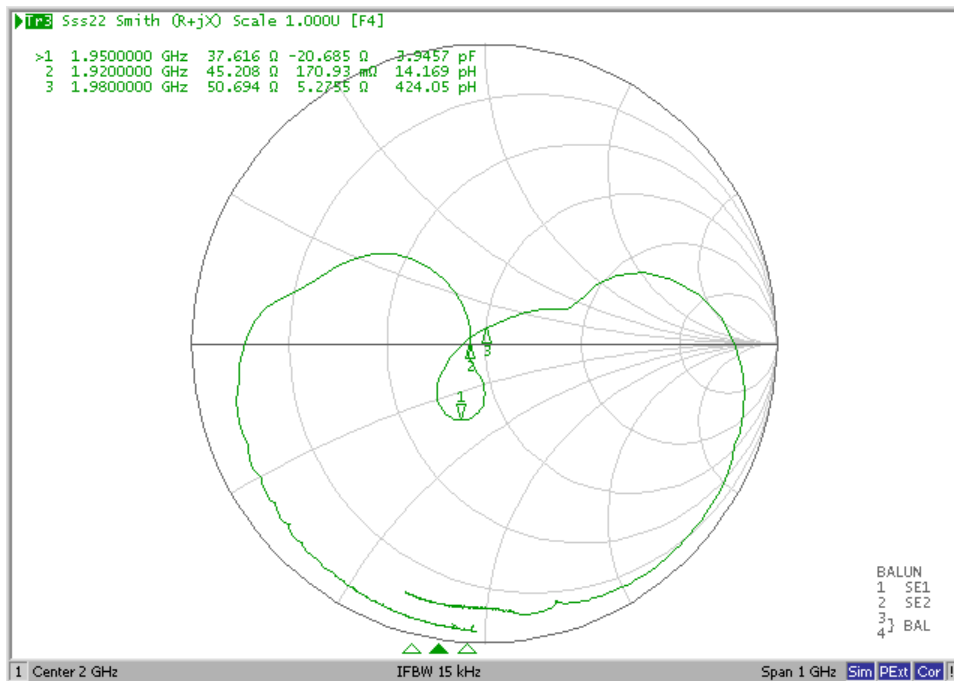

VSWR (Rx Port)

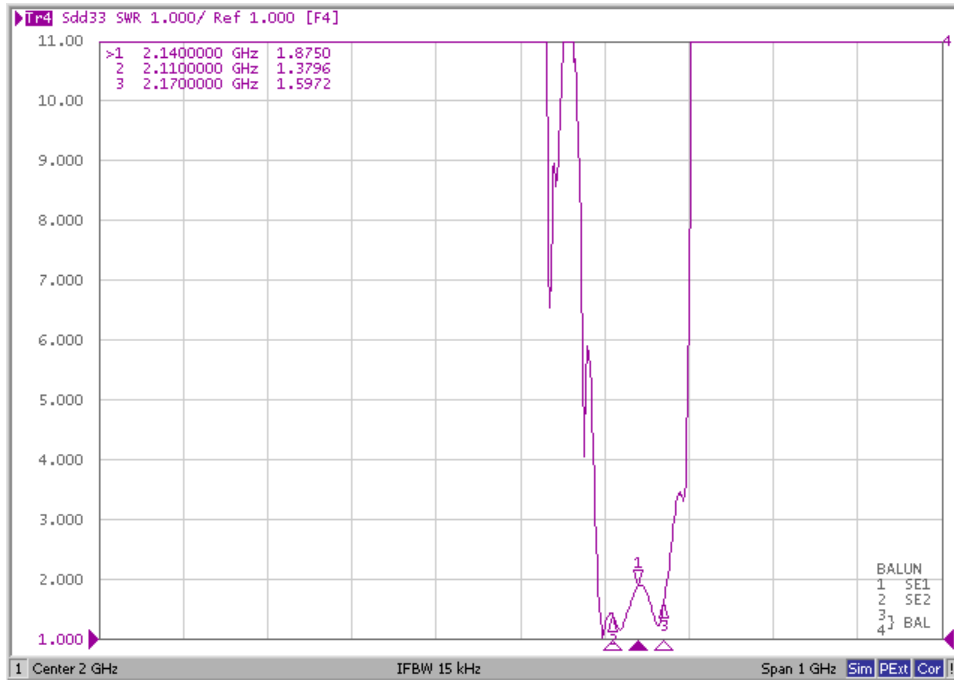

Smith Chart (Rx Port)

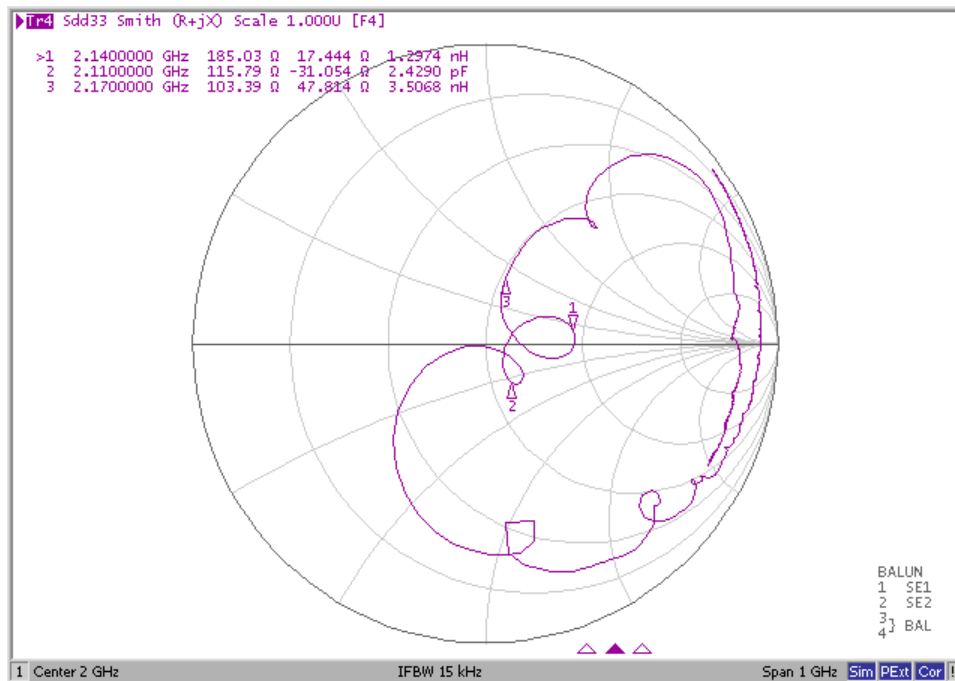

VSWR (ANT Port)

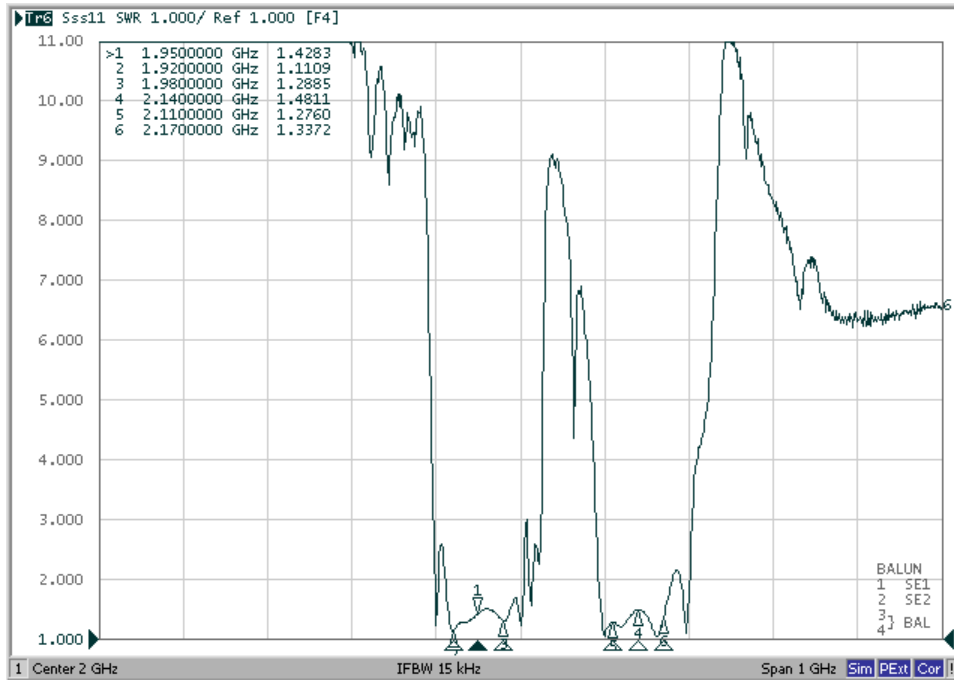

Smith Chart (ANT Port)

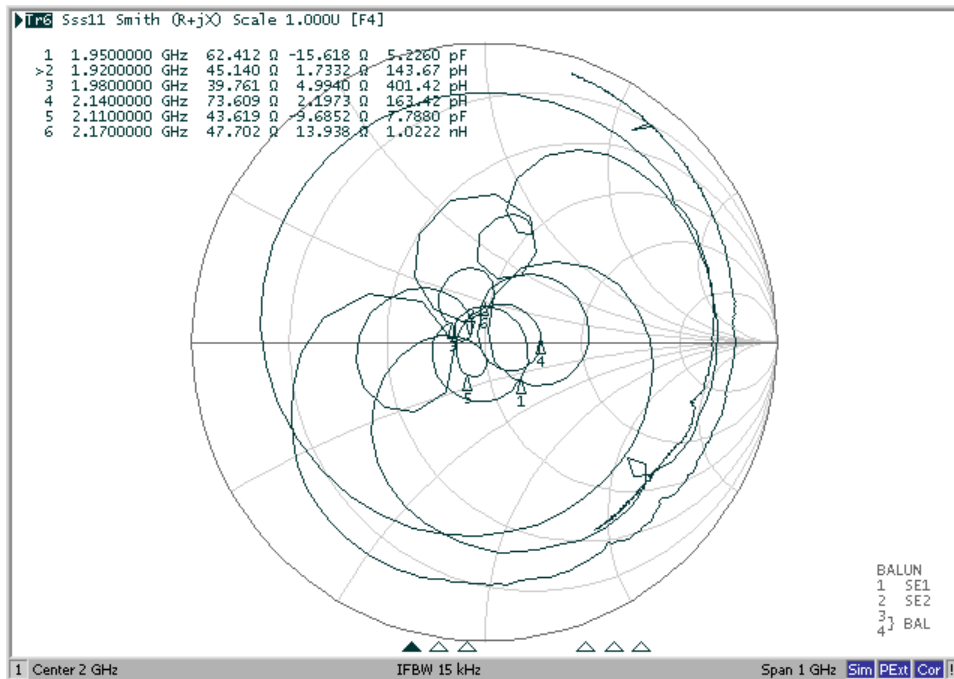

Phase Balance

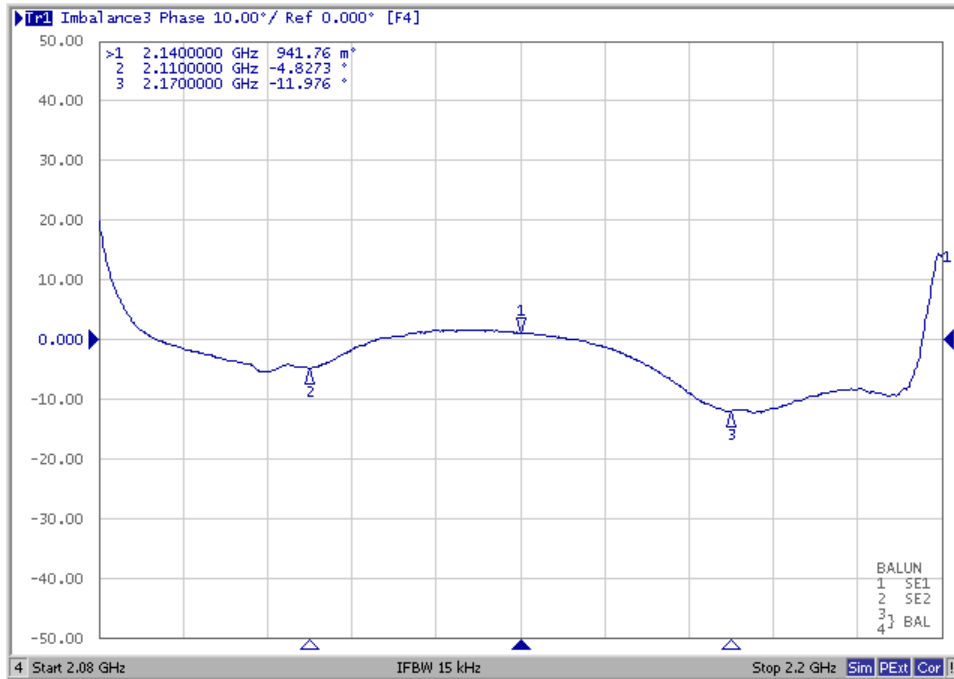

Amplitude Balance

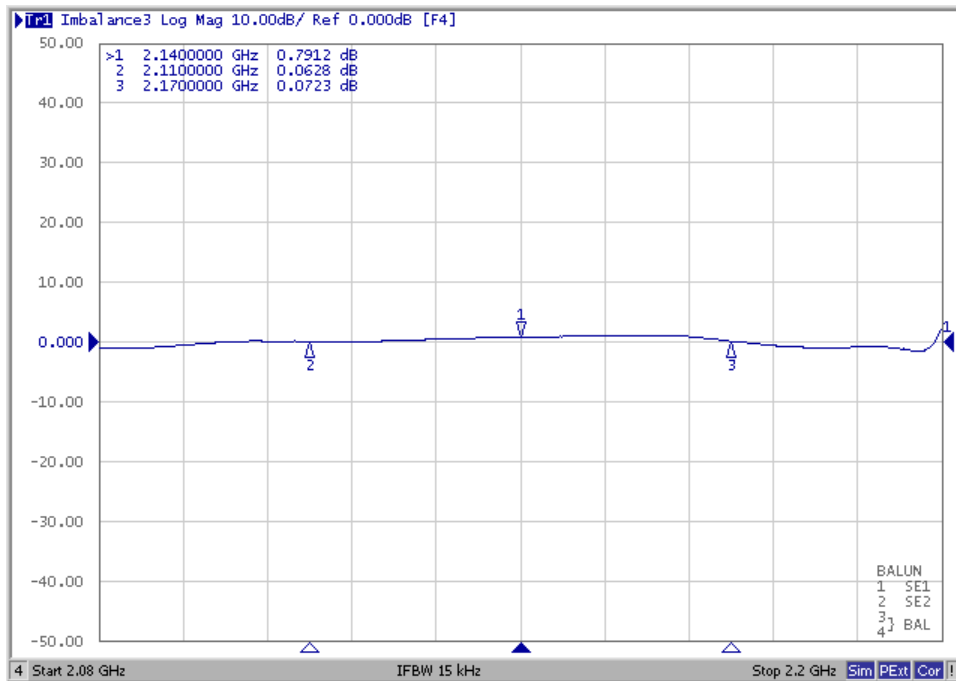

Wide Span

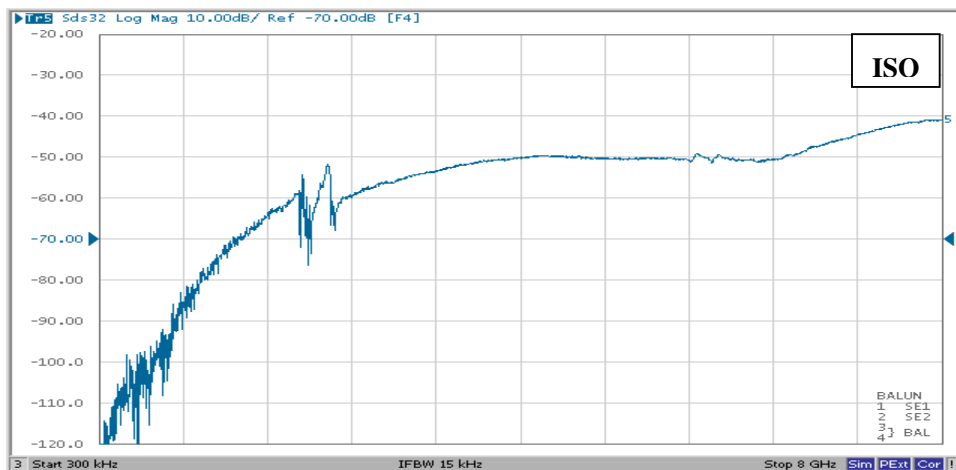
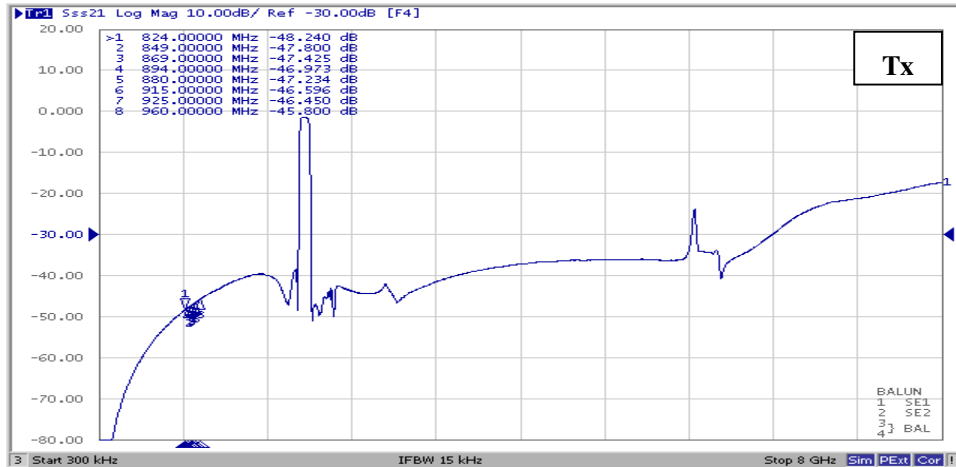

**D.OUTLINE DRAWIN:
(Mass Production)**

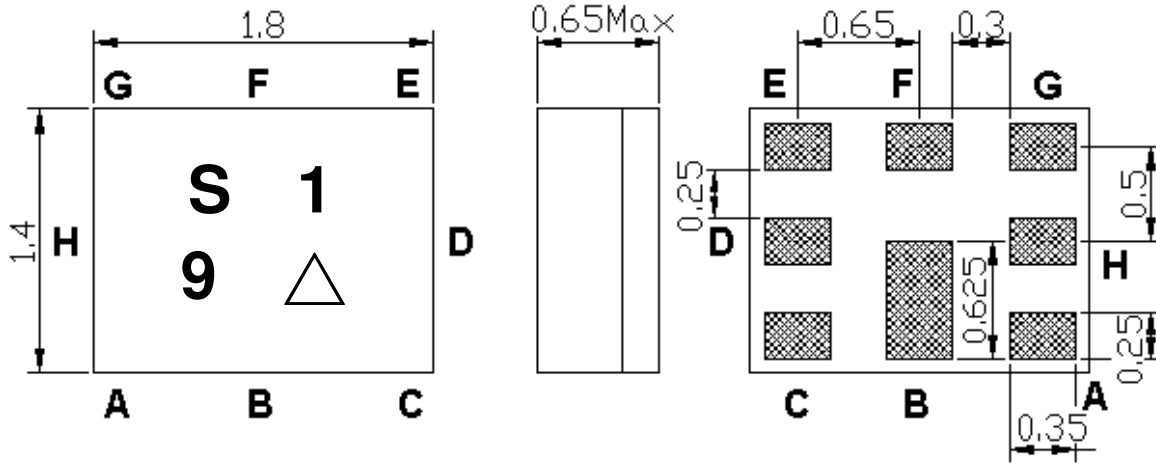

Marking Descriptions	
S	Marking name
1	Band Class
9	Series Number
△	Date Code(Year+Month)

Pin Description	
B,D,E,G	Ground
F	Ant
C	Tx (1950.0MHz)
A,H	Rx (2140.0MHz)

Date Code (year+month)

Year	Jan.	Feb.	Mar.	Apr.	May.	Jun.	Jul.	Aug.	Sep.	Oct.	Nov.	Dec.
2013	A	B	C	D	E	F	G	H	J	K	L	M
2014	N	P	Q	R	S	T	U	V	W	X	Y	Z
2015	a	b	c	d	e	f	g	h	j	k	l	m
2016	n	p	q	r	s	t	u	v	w	x	y	z
2017	<u>A</u>	<u>B</u>	<u>C</u>	<u>D</u>	<u>E</u>	<u>F</u>	<u>G</u>	<u>H</u>	<u>J</u>	<u>K</u>	<u>L</u>	<u>M</u>
2018	<u>N</u>	<u>P</u>	<u>Q</u>	<u>R</u>	<u>S</u>	<u>T</u>	<u>U</u>	<u>V</u>	<u>W</u>	<u>X</u>	<u>Y</u>	<u>Z</u>
2019	<u>a</u>	<u>b</u>	<u>c</u>	<u>d</u>	<u>e</u>	<u>f</u>	<u>g</u>	<u>h</u>	<u>i</u>	<u>k</u>	<u>l</u>	<u>m</u>
2020	<u>n</u>	<u>p</u>	<u>q</u>	<u>r</u>	<u>s</u>	<u>t</u>	<u>u</u>	<u>v</u>	<u>w</u>	<u>x</u>	<u>y</u>	<u>z</u>

E.Evaluation Circuit

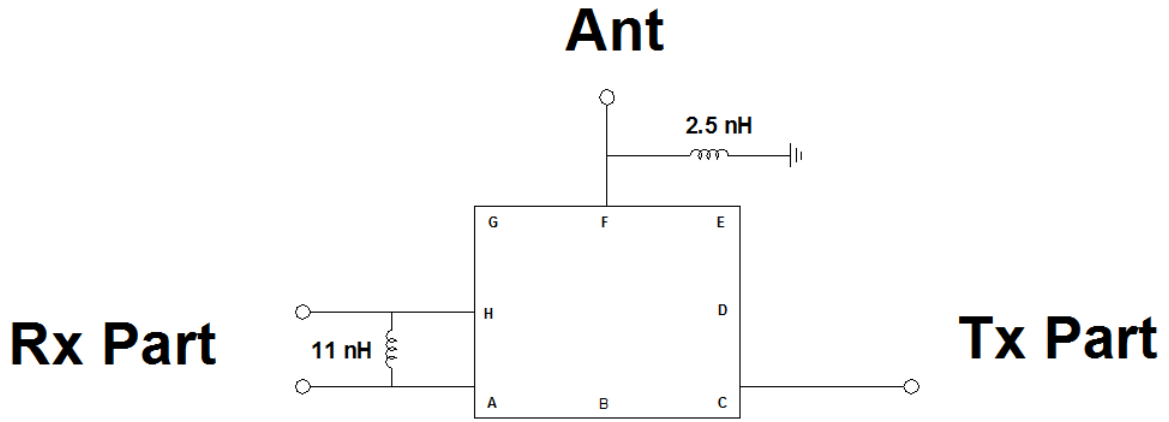

F. FOOTPRINT:

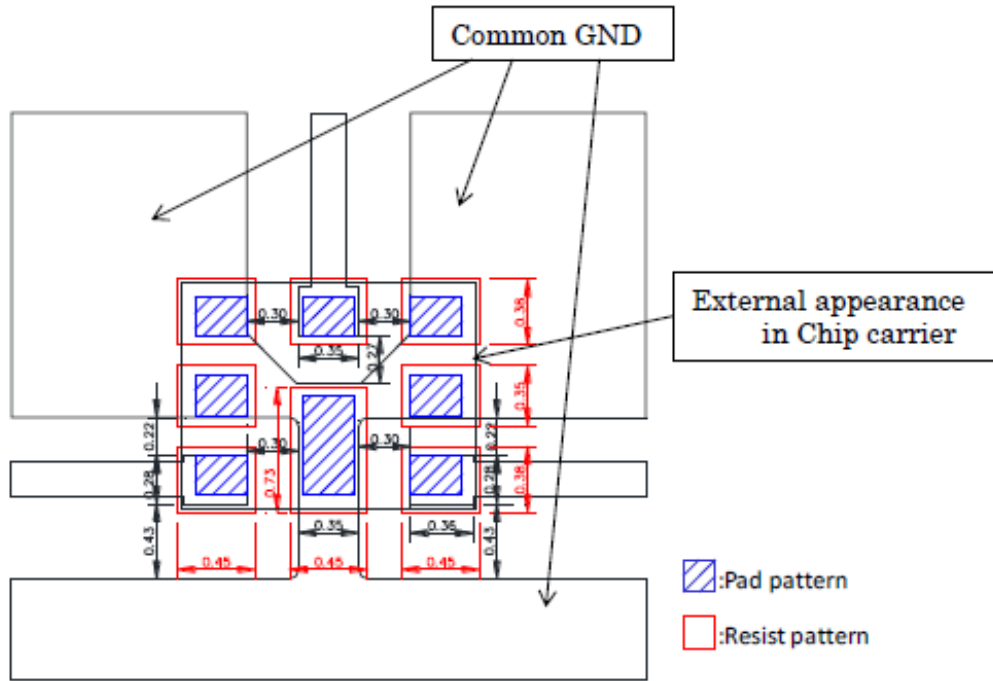

G. PACKING:

1. REEL DIMENSION

(Please refer to FR-75D10 for packing quantity)

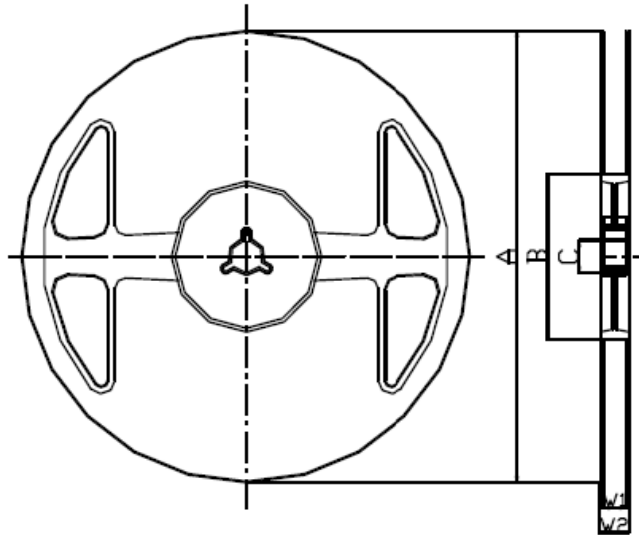

Materials of Reel

Material : Polystyrene + Carbon

Characteristics : Conforms to EIAJ-ET-7200A

Color : Black

Surface resistance (reference value) : $10^9\Omega/\text{sq Max.}$

Unit : mm

Code	Quantity	A	B	C	W1	W2
Z	3,000 pcs	$\phi 180.0 +0.0/-1.5$	$\phi 66.0 +/-0.5$	$\phi 13.0 +/-0.2$	$9.0 +1.0/-0.0$	$11.4 +/-1.0$

2. TAPE DIMENSION

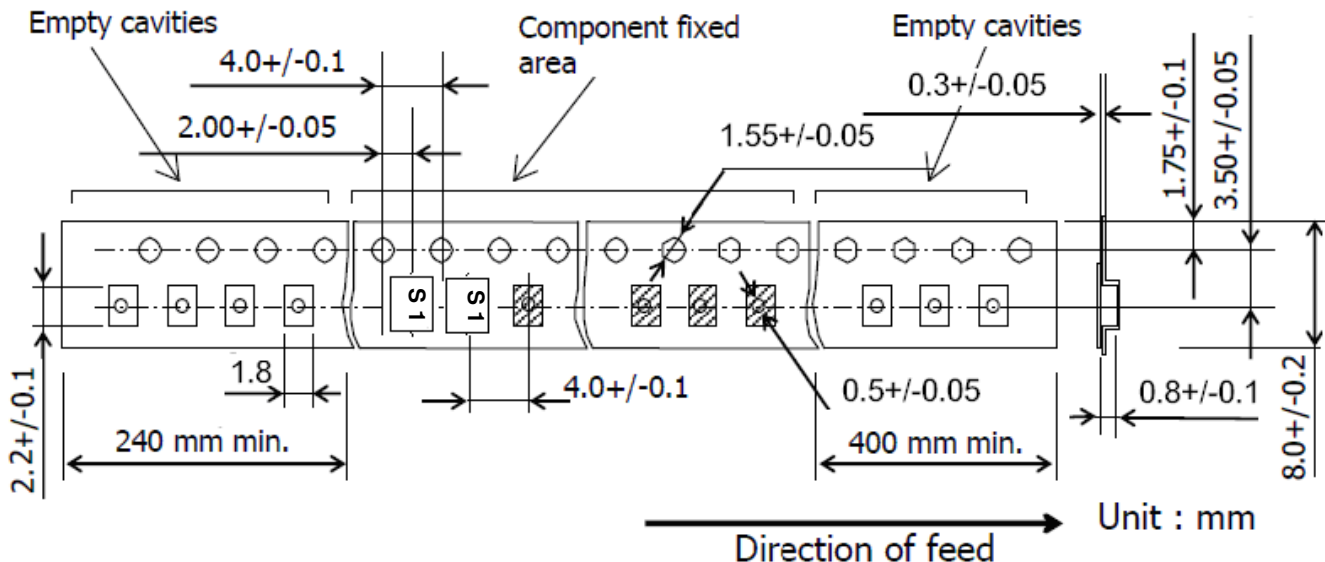

H. RECOMMENDED REFLOW PROFILE :

1. Preheating shall be fixed at 150~180°C for 60~90 seconds.
2. Ascending time to preheating temperature 150°C shall be 30 seconds min.
3. Heating shall be fixed at 220°C for 50~80 seconds and at 245~260°C peak (min. 10sec).
4. Time : 2 times.

