

序号	品名	材质
①	1.50-K型立式WTB胶芯带扣	PAGT UL94V-0 米白色
②	1.50-K型立式WTB端子	黄铜/表面镀锡
③	1.50-K型立式WTB吸盖	LCP E473i 本色/黑色

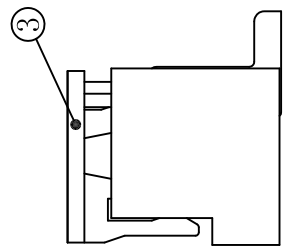

WITH COVER

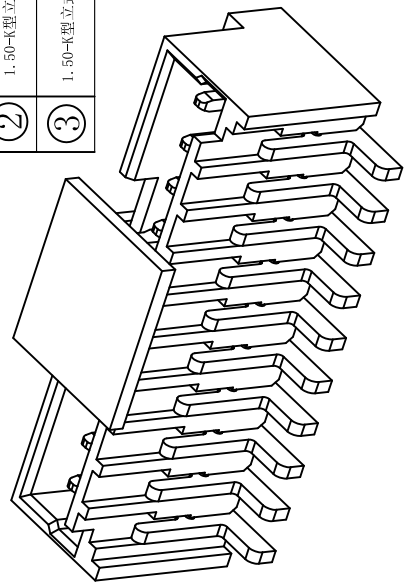
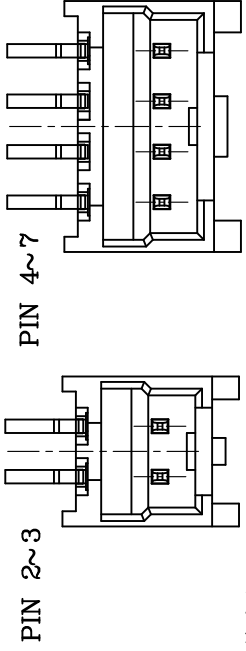
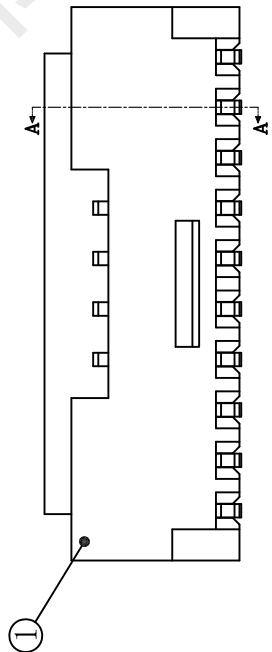
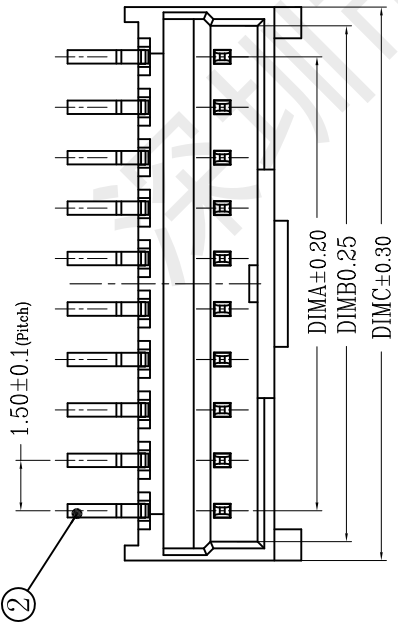
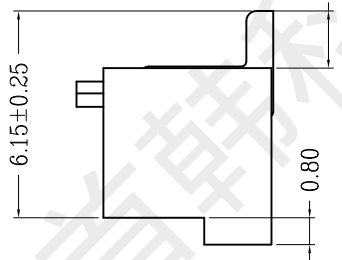

适用线路板

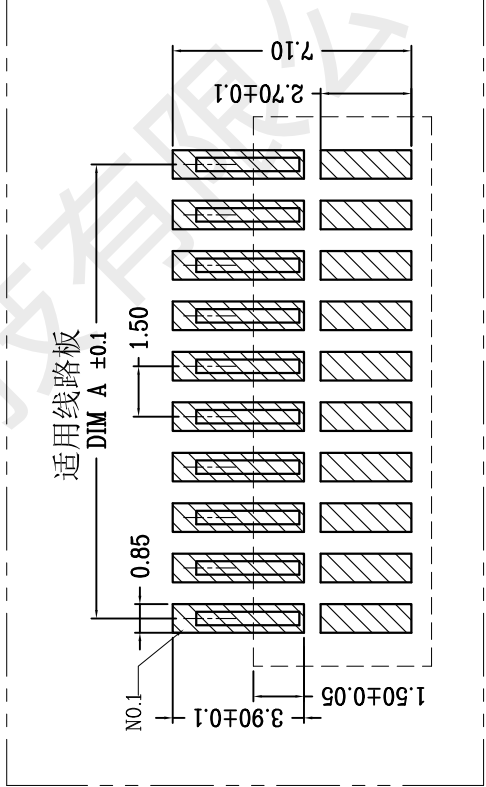

CKT	DIM A	DIM B	DIM C
2	1.50	3.35	4.46
3	3.00	4.85	5.96
4	4.50	6.35	7.46
5	6.00	7.85	8.96
6	7.50	9.35	10.46
7	9.00	10.85	11.96
8	10.50	12.35	13.46
9	12.00	13.85	14.96
10	13.50	15.35	16.46
11	15.00	16.85	17.96
12	16.50	18.35	19.46
13	18.00	19.85	20.96
14	19.50	21.35	22.46
15	21.00	22.85	23.96

技术指标:

1. 塑件表面应光洁、无毛边、无明显收缩、缺陷、裂纹等现象。
2. 温度范围: $-25^{\circ}\text{C} \sim 85^{\circ}\text{C}$ 。
3. 额定电压: 350V AC, DC。
4. 接触电阻: $\leq 0.02\Omega$ 。
5. 绝缘电阻: $\geq 1000\text{M}\Omega$ 。
6. 额定电流: 3A AC, DC。

首韩 SHOUHAN
深圳市首韩科技有限公司

制图 (DR) 李春风
审核 (CHKD) 钟华华
批准 (APPD) 罗李金

品名 (TITLE) 针座
料号 (DWG.NO) 1.5mm-3P LITDK
张数 (SHEET) 1 OF 1
比例 (SCALE) 1:1
单位 (UNITS) mm

一般公差 (TOLERANCE)
X ±0.10
Y ±0.20
Z ±0.30
ANGLES ±1°



深圳市首韩科技有限公司

SHENZHEN SHOUHAN TECHNOLOGY CO., LTD

Tel: 0755-27597601 Fax: 0755-27597491

承 认 书

SPECIFICATION FOR APPROVAL

客 户 Customer:

产品名称 Project:

针座

规格型号 Part No:

1.5mm-3P LTKD

贵公司承认印 Approval signatures

料 号/Part No.	签 章/Signatures

日期 Date:

拟制/Drawn	李春风	
审核/Check	钟华华	
批准/Approved	罗孝金	

1、SCOPE: (适用范围)

1.1 This specification covers production and inspection of Connector.

本规范内容适用于本公司普通系列型条形连接器（针座）产品的生产与检验。

2、USE CONDITION: (使用条件)

2.1 Ambient temperature Range:-25℃~+85℃

环境温度：-25℃~+85℃

2.2 Applicable PC board thickness:1.2~1.6mm

适用 PC 板厚度：1.2~1.6 mm

3、Appearance and Dimension: (外观及尺寸)

3.1 Appearance:Product surface without defect、dirt、crack、and mechanical damang, Contact without rust,plating not oxided and not peeled.

产品表面不应有对制品有害的缺陷、污垢、裂痕及机械损伤；接触件无锈蚀、镀层氧化、脱落等现象。

3.2 Dimension:According to drawings

外形尺寸：依照附图

3.3 Exchangable:Exchangable with same specification products.

互换性：相同规格应能互换

4、Material:

材 料 （以图纸为准）

P/N 零件名称	Type 类 型	Material 材 料	Finish 表面处理	Expiain 说 明
Terminal 端子	Contact 插 簧	Phosphor bronze 锡青磷铜 厚 0.15mm	Tin Plating:3~4 μ m 镀锡：3~4 μ m	RoHS Comp liant
Housing 孔 座	Plastic 塑 壳	Nylon66 UL94V-0	Color:White 颜色：白色	
OpeningWafer 开口针座	Contact 插 针	Phosphor bronze 锡青磷铜 厚 0.30mm	Tin Plating:3~4 μ m 镀锡：3~4 μ m	
	Plastic 塑 壳	Nylon46 UL94V-0	Color: Beige 颜色：米色	
Lips Wafer 闭口针座	Contact 插 针	Phosphor bronze 锡青磷铜 厚 0.30mm	Gold Plating:3~4 μ " m 镀金：3~4 μ " m	
	Plastic 塑 壳	PBT UL94V-0	Color: White 颜色：白色	
Tiepian Wafer 卧贴针座 立贴针座	Contact 插 针	Phosphor bronze 锡青磷铜 厚 0.30mm	Tin Plating:3~4 μ m 镀锡：3~4 μ m	
	Solder tabs 焊护耳	Phosphor bronze 锡青磷铜 厚 0.25mm	Tin Plating:3~4 μ m 镀锡：3~4 μ m	
	Plastic 塑 壳	Nylon46 UL94V-0	Color: Beige 颜色：米色	

5、Electrical Performance:

电气性能

NO. 序号	Item 项目	Requirement 技术要求
5.1	Voltage Rated 额定电压	350V AC DC
5.2	Current Rated 额定电流	3A AC DC
5.3	Contact Resistance 接触电阻	$\leq 20 \text{ m}\Omega$
5.4	Insulation Resistance 绝缘电阻	$\geq 1000 \text{ M}\Omega$
5.5	Dielectric Strength 耐压	$\geq 800 \text{ V AC/minute}$

6、Mechanical Performance:

机械性能

NO. 序号	Item 项目	Requirement 技术要求
6.1	Male contact Retention force PIN 针固定力	$\geq 10 \text{ N}$ per pin
6.2	Female contact Retention force 端子固定力	$\geq 10 \text{ N}$ per pin
6.3	Plug-in force 插入力	$\leq 3 \text{ N}$ per pin
6.4	Plug-out force 拔出力	$\geq 0.5 \text{ N}$ per pin

7、Endurance Characteristics:

环境性能

NO. 序号	Item 项目	Requirement 技术要求
7.1	Soldering rest 可焊性	Time: $2.5 \pm 0.5 \text{ S}$ 时间: $2.5 \pm 0.5 \text{ S}$ Temperature: $260 \pm 5^\circ \text{C}$ 温度: $260 \pm 5^\circ \text{C}$ Area of Soldering: $\geq 95\%$ 焊锡面积: $\geq 95\%$
7.2	Resistance to soldering Heat 耐焊接热	Time: $5 \pm 1 \text{ S}$ 时间: $5 \pm 1 \text{ S}$ Temperature: $260 \pm 5^\circ \text{C}$ 温度: $260 \pm 5^\circ \text{C}$ Appearance: NO Damage 外观: 无损坏

7.3	Heat test 耐热性	Time:96h 时间: 96 小时 Temperature:+85±3℃ 温度: +85±3℃ Appearance:NO Damage 外观: 无损坏 Contact resistance: ≤20 mΩ 接触电阻: ≤20 mΩ
7.4	Cold test 耐冷性	Time:48h 时间: 48 小时 Temperature:-25±3℃ 温度: -25±3℃ Appearance:NO Damage 外观: 无损坏 Contact resistance:≤20 mΩ 接触电阻: ≤20 mΩ
7.5	Temperature Cycling 温度循环	Low temperature:-25±3℃ 低温: -25±3℃ High temperature:-85±3℃ 高温: -85±3℃ For 5 cycles.test after keeping in Normal Condition for 30 min. 5 次循环后, 放置在正常环境中 30 分钟, 在进行测试 Appearance: NO Damage 外观: 无损坏 Contact resistance: ≤20 mΩ 接触电阻: ≤20mΩ
7.6	Invariab lenes humidity 恒定湿热	Temperature:60±2℃ 温度: 60±2℃ Relative humidity:90%-96% RH 相对湿度: 90%-96% RH Tim:96h 时间: 96 小时 Appearance:NO Damage 外观: 无损坏 Contact resistance: ≤20 mΩ 接触电阻: ≤20 mΩ Insulation Resistance: ≥100MΩ 绝缘电阻: ≥100 MΩ
7.7	Salt Spray 盐雾试验	Salt concentration: 5±1% 浓度: 5±1% Temperature:35±2℃ 温度: 35±2℃ Tim:16±2h 时间: 16±2 小时 After salt is removed by running wafer and A drop is removed ,it is measured. 把试验样品从试验箱顶悬挂下来, 采用浓度 (5±1) %的氯化钠溶液, 连续雾化 16 小时, 试验后用流动的蒸馏水 轻轻洗去表面沉积物, 在常温常驻湿条件下恢复 1-2 小时, 外观无损伤 Appearance:NO Damage 外观: 无损坏 Contact resistance: ≤20 mΩ 接触电阻: ≤20 mΩ