

OPERATIONAL AMPLIFIER WITH EVR

■ GENERAL DESCRIPTION

The NJM2172 is single supply, dual OP-AMP with electric variable resistor (EVR), which contains buffer amplifier, OP-AMP, reference voltage circuit, EVR and EVR control circuit.

The reference is fixed around $1/2 V^+$ level internally, and only required few external parts.

The A and B EVR is control separately, and amp drive up to 100Ω (typ.) load. The NJM2172 is suitable for camcorder, CD, MD, and other audio signal process system.

■ PACKAGE OUTLINE

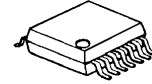

NJM2172V

■ FEATURES

- Low Power Supply Voltage
- Low Operating Current
- A/Bch EVR adjust is separately
- EVR range
- Drivability
- Bipolar Technology
- Package Outline

$V^+ = 2.7$ to $5.5V$
 $I_{cc} = 5.0mA$ typ.

-3.0 to $-95dB$
 100Ω typ.

SSOP14

■ BLOCK DIAGRAM

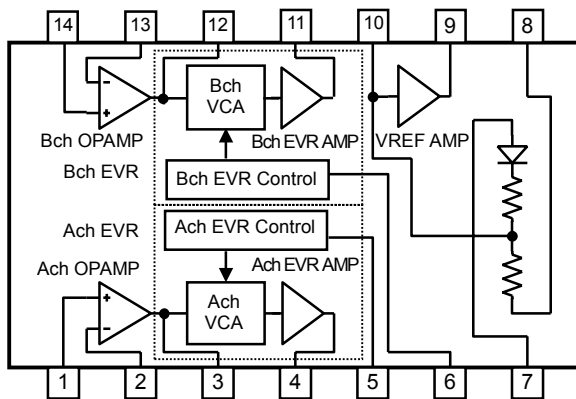

■ PIN CONFIGURATION

- 1: $OP_{+IN}A$
- 2: $OP_{-IN}A$
- 3: $OP_{OUT}A$
- 4: $EVR_{OUT}A$
- 5: $V_{CNT}A$
- 6: $V_{CNT}B$
- 7: V^+
- 8: GND
- 9: V_{ref}
- 10: REF_{IN}
- 11: $EVR_{OUT}B$
- 12: $OP_{OUT}B$
- 13: $OP_{-IN}B$
- 14: $OP_{+IN}B$

NJM2172

■ ABSOLUTE MAXIMUM RATING

(Ta=25°C)

PARAMETER	RATINGS	SYMBOL(UNIT)	OTHERS
Supply Voltage	+7.0	V _{DD} (V)	
Storage Temperature Range	-50 to +150	T _{stg} (°C)	
Operating Temperature Range	-40 to +85	T _{opr} (°C)	
Power Dissipation	300	P _D (mW)	SSOP14 (ONLY)

■ ELECTRICAL CHARACTERISTICS (V⁺=3.5V, C_{refin}=10pF, C_{ref}=1μF, f=1kHz, Ta=25°C unless otherwise noted)

● SUPPLY

PARAMETER	SYMBOL	TEST CONDITION	MIN.	TYP.	MAX.	UNIT	TEST CIRCUIT
Operating Current	I _{CC}	R _L =∞	-	5.0	7.5	mA	1
Reference Voltage	V _{ref}	R _L =∞	1.45	1.55	1.65	V	1

● OP-AMP SECTION

PARAMETER	SYMBOL	TEST CONDITION	MIN.	TYP.	MAX.	UNIT	TEST CIRCUIT
Input Offset Voltage	V _{IO}	R _S ≤10kΩ	-	1.0	6.0	mV	3
Input Bias Current	I _{IB}		-	100	300	nA	3
Voltage Gain 1	G _{V1}	R _L ≤10kΩ	60	80	-	dB	3
Maximum Output Voltage Swing 1	V _{OM1}	THD=1%, R _L ≥2.5kΩ	-3.0 (0.7)	0 (1.0)	- (-)	dBV (V _{rms})	2
Input Common Mode Voltage Range	V _{ICM}	-	0.55 to 2.55	-	-	V	-
Output Noise Voltage	V _{ON1}	R _s =600Ω / A-Weighted	-	-100 (10.0)	-90 (30.0)	dBV (μV _{rms})	1
Common Mode Rejection Ratio	CMR	R _S ≤10kΩ	60	74	-	dB	3
Supply Voltage Rejection Ratio	SVR	R _S ≤10kΩ	60	80	-	dB	3
Gain Bandwidth Product	GB		-	2	-	MHz	-

● EVR SECTION (V_{CNT}=2.7V, R_L=100Ω unless otherwise noted)

PARAMETER	SYMBOL	TEST CONDITION	MIN.	TYP.	MAX.	UNIT	TEST CIRCUIT
Voltage Gain 2	G _{V2}	V _{IN} = -10dBV	-6.0	-3.0	0.0	dB	1
Total Harmonic Distortion	THD	V _{IN} = -10dBV	-	0.15	1.0	%	2
EVR Gain	G _{EVR}	V _{IN} =-10dBV/V _{CNT} =2.7Vto GND	80	90	-	dB	1
Output Noise Voltage 2	V _{NO2}	R _S = 600Ω / A - Weighted	-	-95 (18.0)	-85 (56.0)	dBV (μVrms)	1
Maximum Output Voltage Swing 2	V _{OM2}	THD = 1%	-5.0 (0.56)	-3.0 (0.71)	-	dBV (Vrms)	2
Channel Separation	CS	V _{IN} =-10dBV / A - Weighted	-	-79 (110)	-70 (320)	dBV (μVrms)	1
EVR Deviation	A/B1	V _{CNT} =1.5V, V _{INA} =V _{INB} =-50dBV f=1kHz, A/B ; *1	-3.0	0.0	3.0	dB	1
	A/B2	V _{CNT} =2.0V, V _{INA} =V _{INB} =-50dBV f=1kHz, A/B ; *1	-3.0	0.0	3.0		

*1: Ach Amp with Bch=0dB

NJM2172

■ TEST CIRCUIT 1

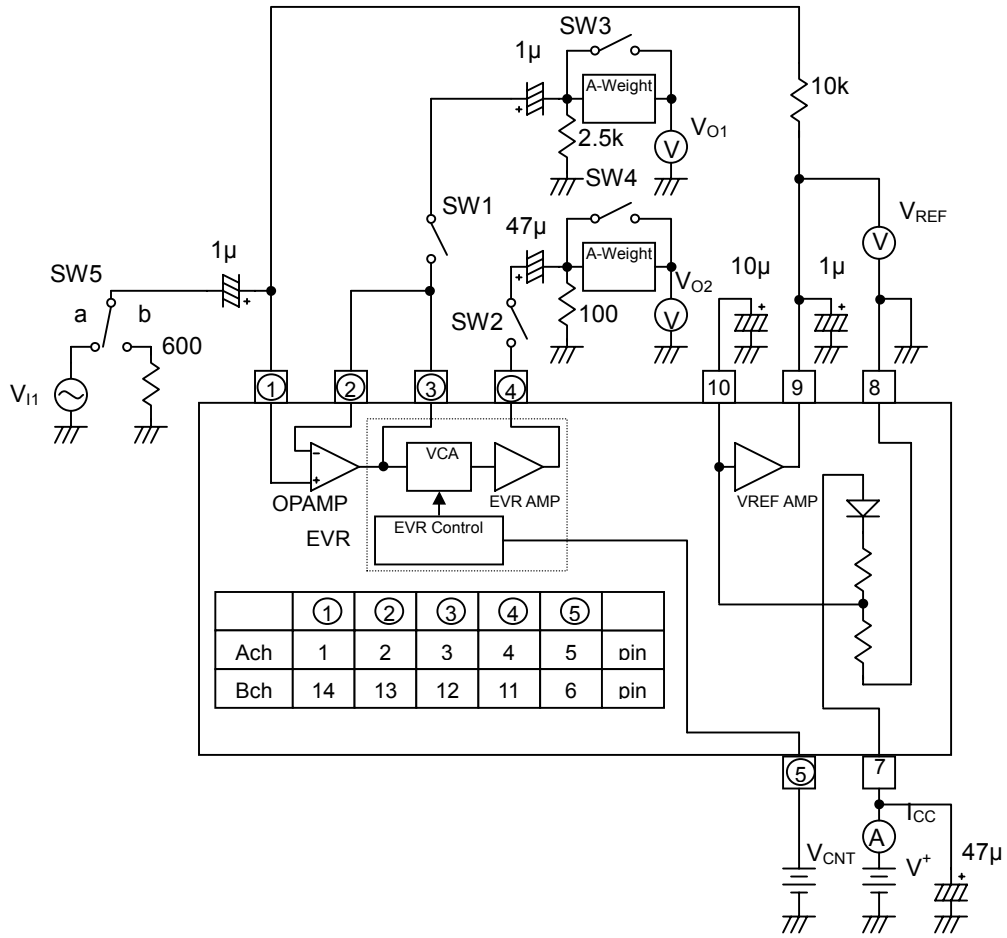

Fig.1

Test circuit 1 shows only Ach.

■ TEST CIRCUIT 2

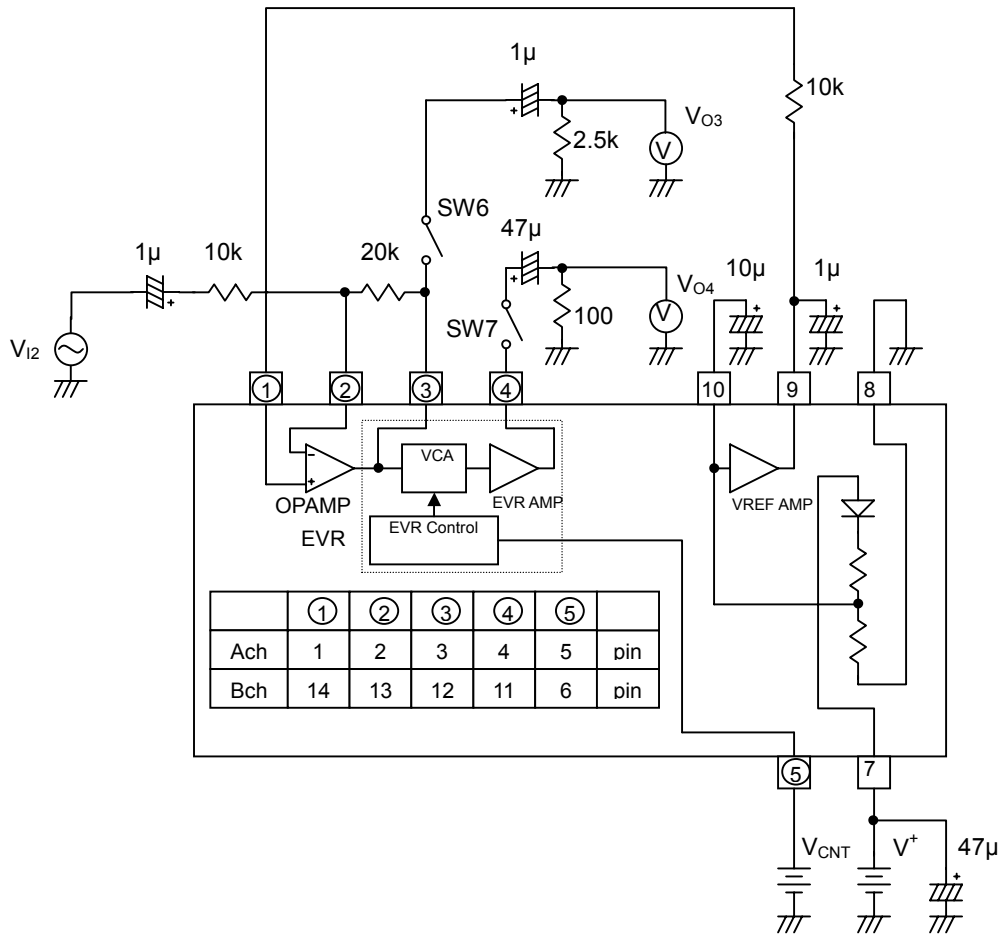

Fig.2

Test circuit 2 shows only Ach.

■ PIN INFORMATION

Pin No.	Pin Name	Function
1	OP+IN A	Ach OP-AMP + Input
2	OP-IN A	Ach OP-AMP - Input
3	OPOUTA	Ach OP-AMP Output / EVR Input
4	EVROUT A	Ach EVR Output
5	VCNT A	Ach EVR Control
6	VCNT B	Bch EVR Control
7	V ⁺	Power Supply
8	GND	GND
9	VREF	Internal Reference Output
10	REFIN	Internal Reference Input
11	EVROUT B	Bch EVR Output
12	OPOUT B	Bch OP-AMP Output / EVR Input
13	OP-IN B	Bch OP-AMP - Input
14	OP+IN B	Bch OP-AMP + Input

NJM2172

■ EQUIVALENT CIRCUIT

Term. No.	Term. Name	Equivalent Circuit	Terminal Voltage	Note
1 2 13 14	OP+INA OP-INA OP-INB OP+INB		1.55V	-
3 12	OPOUTA OPOUTB		1.55V	OPOUTA / OPOUTB Load: $RL \geq 2.5k\Omega$
4 11	EVROUTA EVROUTB		1.55V	EVROUTA / EVROUTB Load: $RL \geq 100\Omega$

Term. No.	Term. Name	Equivalent Circuit	Terminal Voltage	Note
5 6	VCNT A VCNT B		-	Input EVR control voltage
9 10	VREF REFIN		-	Terminal Voltage is $52 / (52+40) \times (V^+ - V_{BE})$ $R_L \geq 2K\Omega$

NJM2172

APPLICATION CIRCUIT 1 Voltage follower

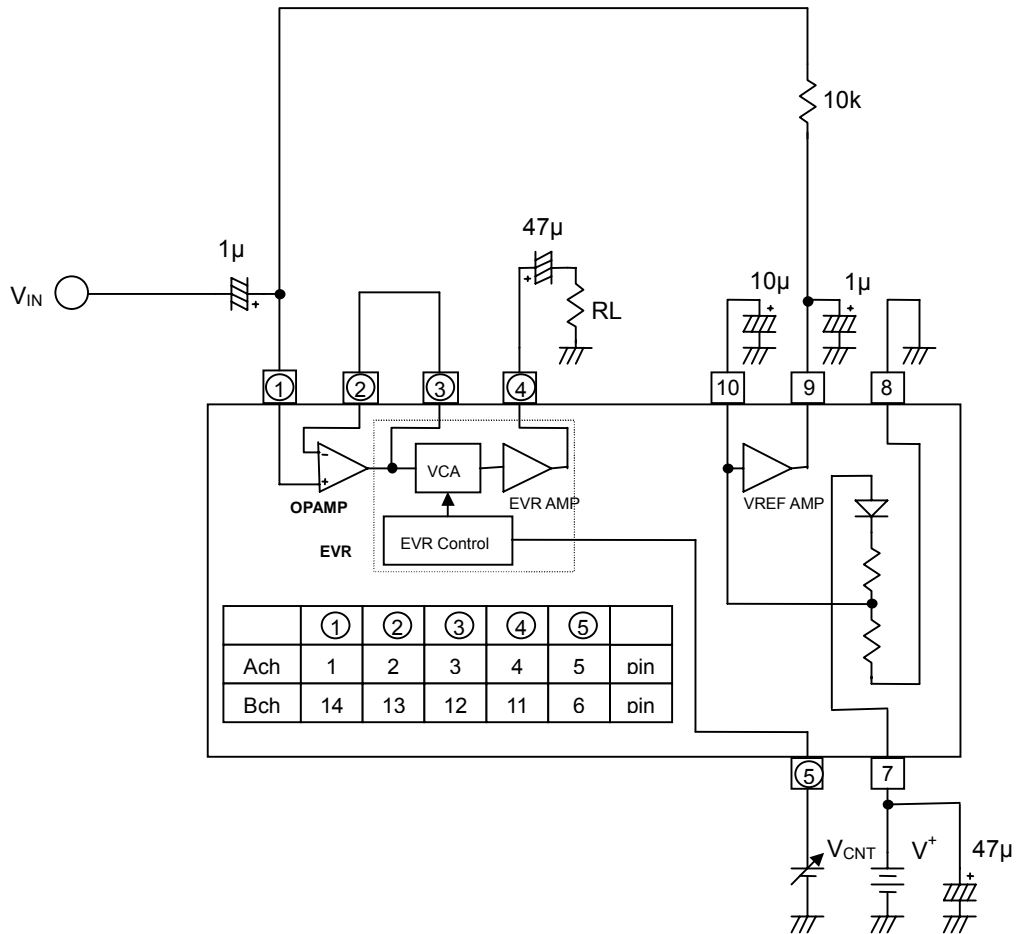

Fig.4

Application circuit 1 shows only Ach.

■ APPLICATION CIRCUIT 2
Invert Circuit ($G_v=6\text{dB}$)

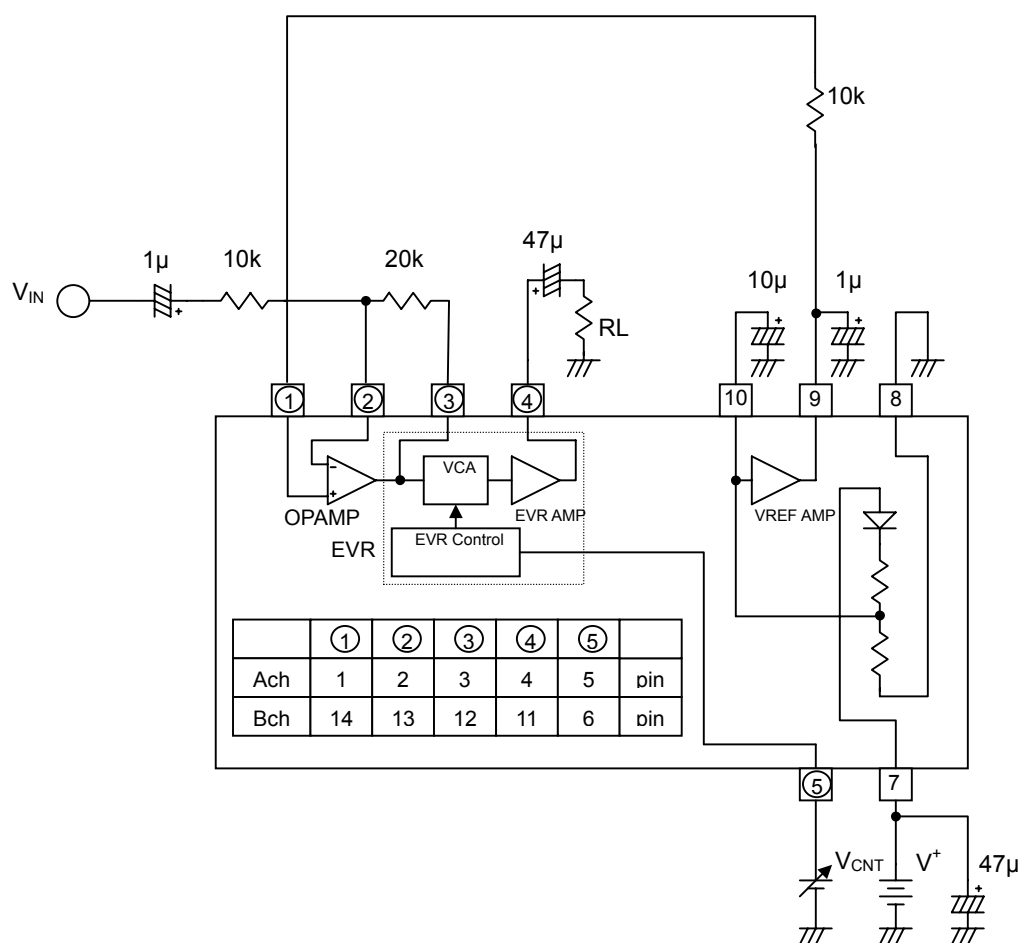

Fig.5

Application circuit 2 shows only Ach.

NJM2172

■ TYPICAL CHARACTERISTICS

Quiescent Current vs. Supply Voltage $T_a=25^\circ\text{C}$

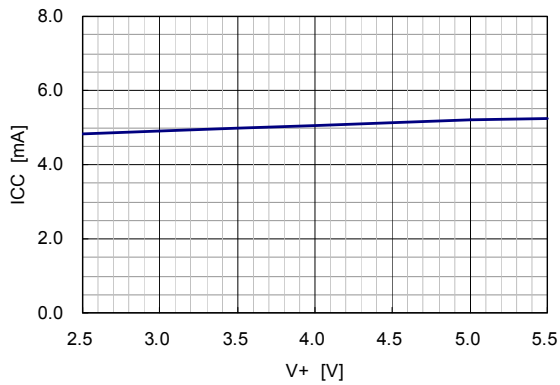

Internal Reference Voltage vs. Supply Voltage $T_a=25^\circ\text{C}$

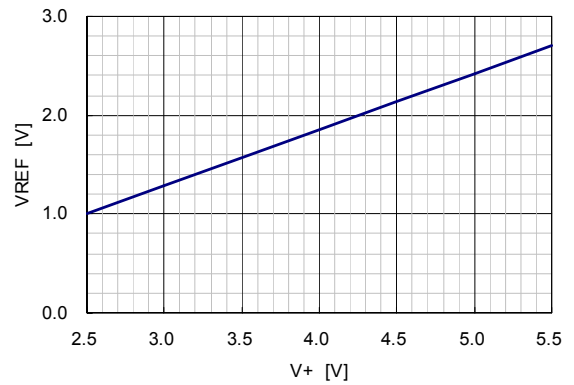

Quiescent Current vs. Temperature $V+=3.5\text{V}$

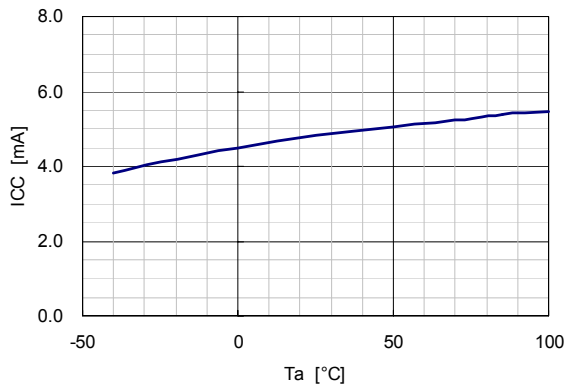

Internal Reference Voltage vs. Temperature $V+=3.5\text{V}$

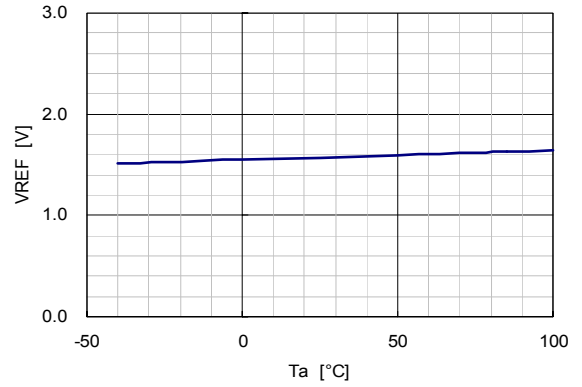

Input Offset Voltage vs. Supply Voltage $T_a=25^\circ\text{C}$

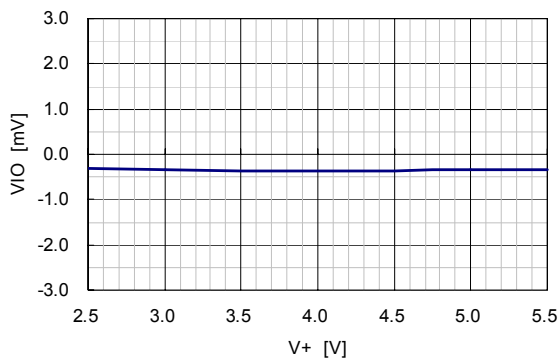

Input Bias Current vs. Supply Voltage $T_a=25^\circ\text{C}$

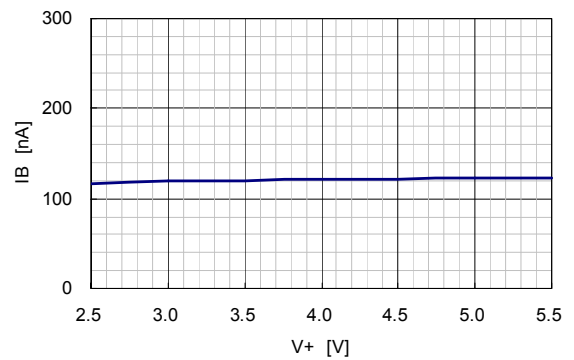

Input Offset Voltage vs. Temperature $V+=3.5\text{V}$

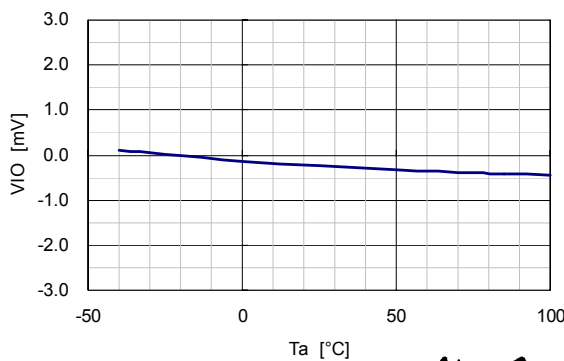

Input Bias Current vs. Temperature $V+=3.5\text{V}$

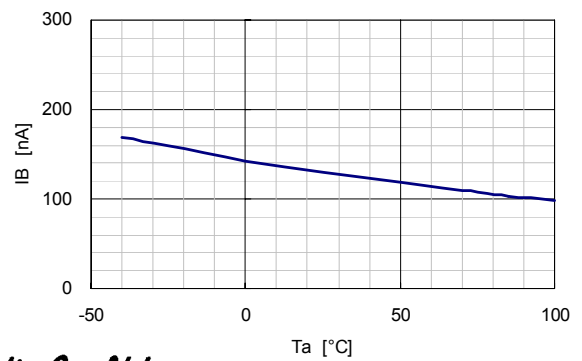

Voltage Gain 1 vs. Frequency
 $V+=3.5V, T_a=25^\circ C, R_L=2.5k\Omega$

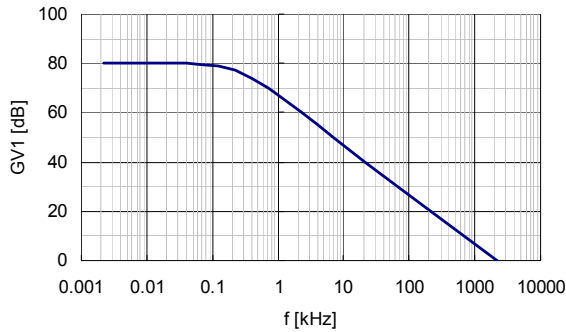

Voltage Gain 1 / Phase vs. Frequency
 $V+=3.5V, T_a=25^\circ C, R_L=2.5k\Omega, 40dB$ Inverted Amp

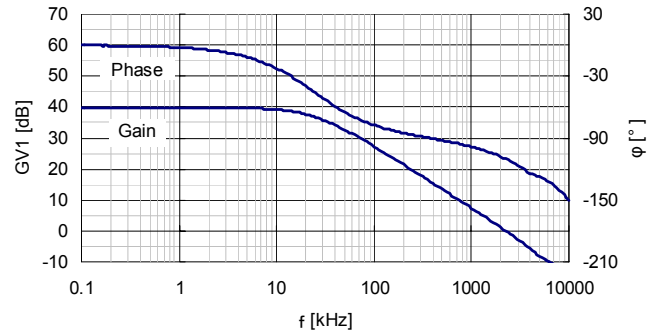

Voltage Gain1 vs. Temperature $V+=3.5V$

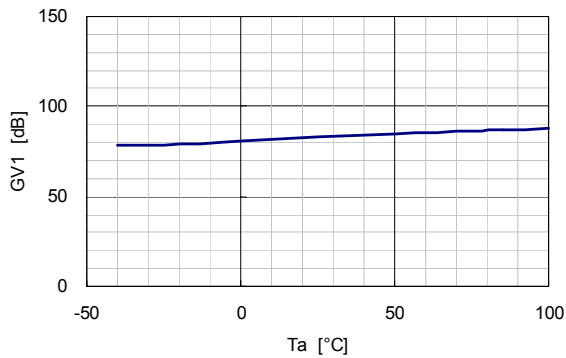

Common Mode Rejection Ratio vs. Temperature $V+=3.5V$

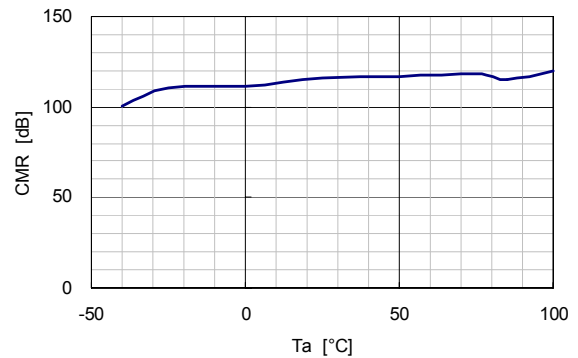

Supply Voltage Rejection Ratio vs. Temperature $V+=3.5V$

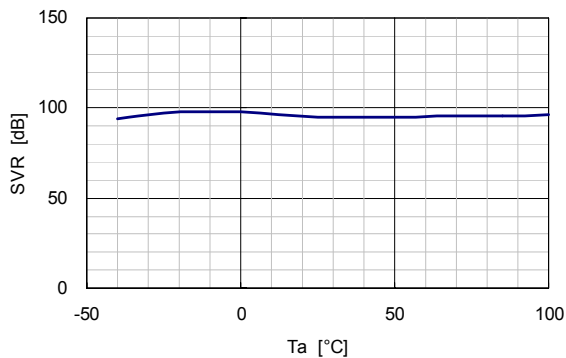

Total Harmonic Distortion (OPAMP) vs. Output Level
 (Temperature)
 $V+=3.5V, f=1kHz, BW=400Hz-30kHz$

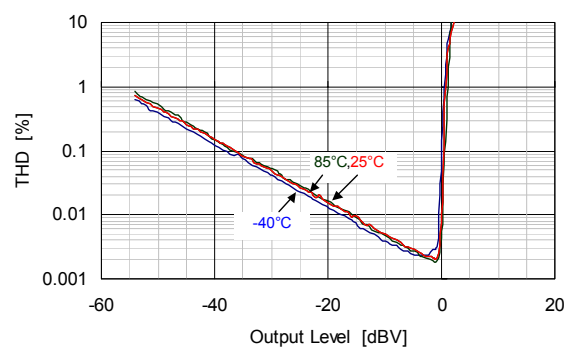

NJM2172

Maximum Output Voltage 1 vs. Supply Voltage
 $R_L=2.5k\Omega, f=1kHz, THD=1\%, T_a=25^\circ C$

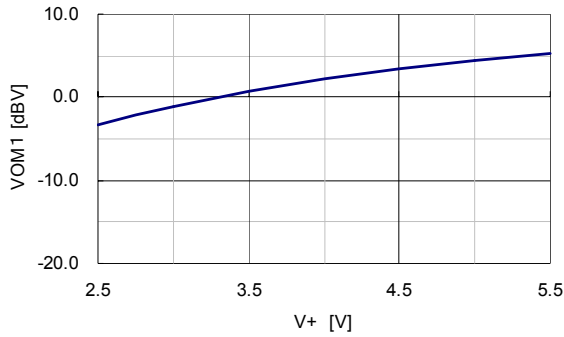

Maximum Output Voltage 1 vs. Load Resistance
 $V+=3.5V, f=1kHz, THD=1\%, T_a=25^\circ C$

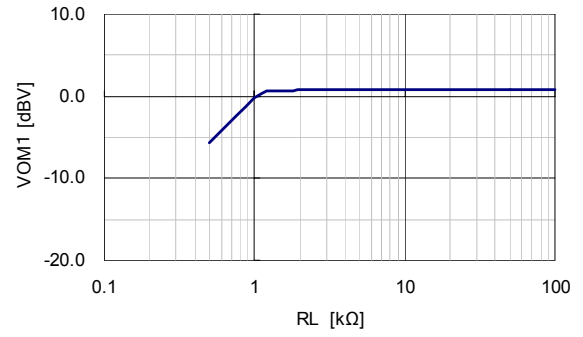

Voltage Gain 2 vs. EVR Control Voltage
 $V+=3.5V, f=1kHz, Vin=-10dBV, T_a=25^\circ C$

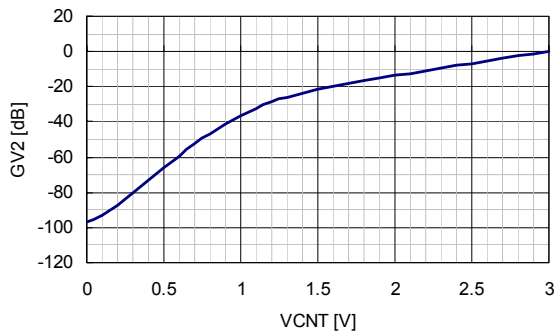

Voltage Gain 2 / Supply Voltage vs. EVR Control Voltage
 $f=1kHz, Vin=-10dBV, T_a=25^\circ C$

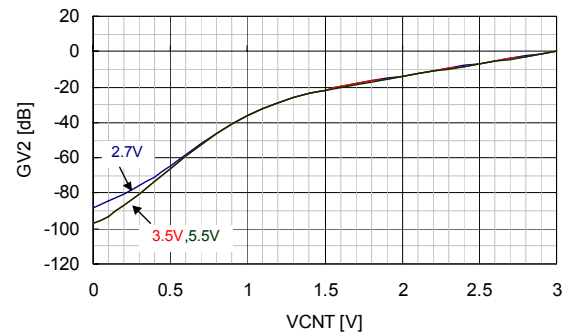

Voltage Gain 2 / Frequency vs. EVR Control Voltage
 $V+=3.5V, Vin=-10dBV, T_a=25^\circ C$

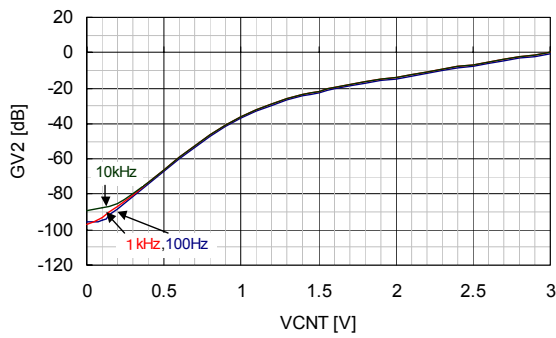

Voltage Gain 2 / Temperature vs. EVR Control Voltage
 $V+=3.5V, f=1kHz, Vin=-10dBV$

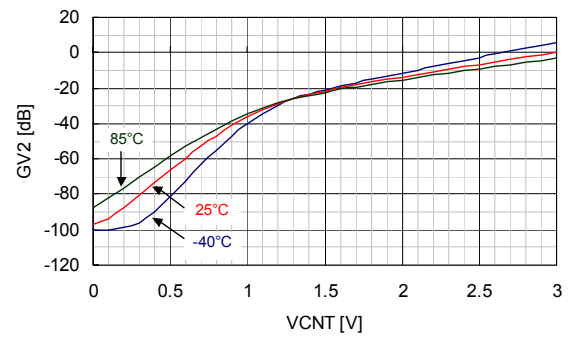

Total Harmonic Distortion (EVR) vs. Output Level
(Frequency)
V+=3.5V, Ta=25°C

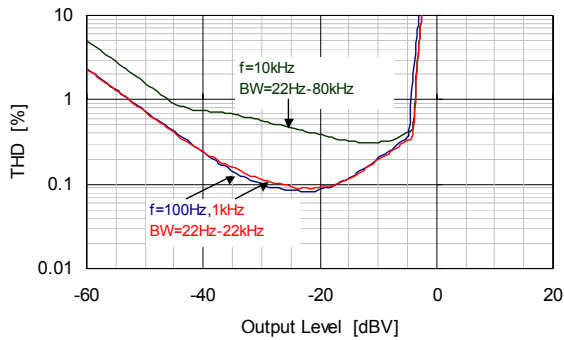

Total Harmonic Distortion (EVR) vs. Output Level
(Temperature)
V+=3.5V, f=1kHz, BW=400Hz-30kHz

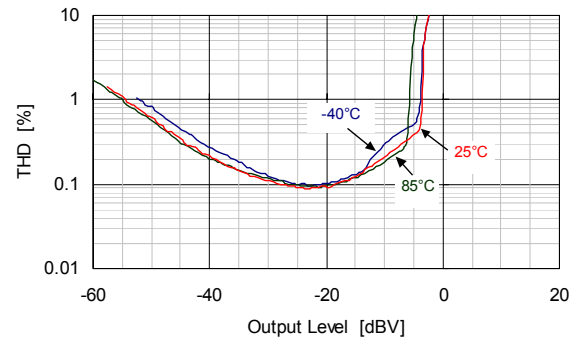

Output Noise Voltage 2 vs. EVR Control Voltage
V+=3.5V, Ta=25°C, A-Weighted

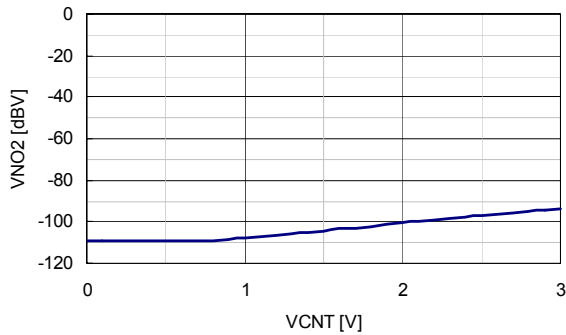

Output Noise Voltage 2 vs. Temperature
V+=3.5V, VCNT=2.7V, A-Weighted

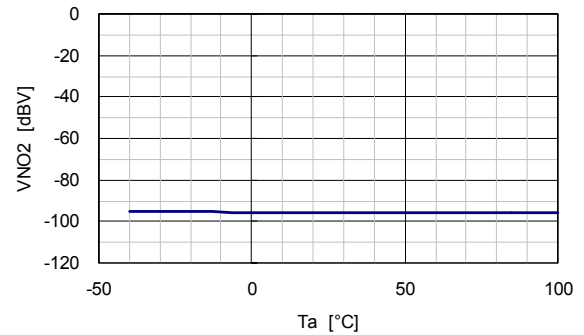

Maximum Output Voltage 2 vs. Supply Voltage
RL=100Ω, f=1kHz, THD=1%, Ta=25°C

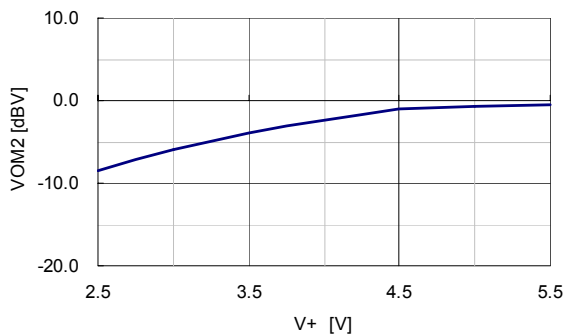

Maximum Output Voltage 2 vs. Load Resistance
V+=3.5V, f=1kHz, THD=1%, Ta=25°C

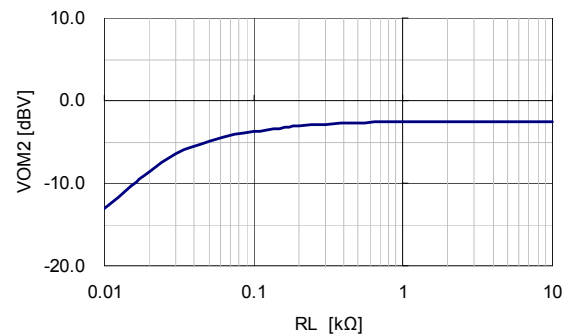

Channel Separation vs. EVR Control Voltage
 $V+ = 3.5V, V_{in} = -10dBV, f = 1kHz, T_a = 25^\circ C, A\text{-Weighted}$

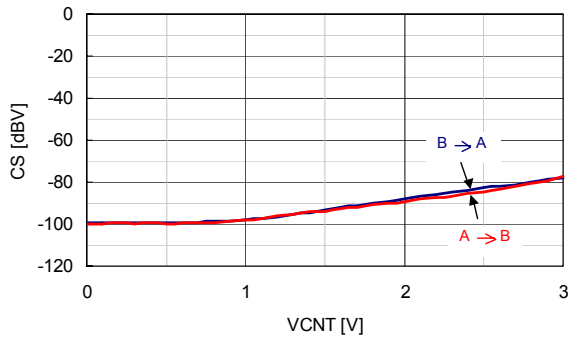

Channel Separation vs. Supply Voltage
 $VCNT = 2.7V, V_{in} = -10dBV, f = 1kHz, T_a = 25^\circ C, A\text{-Weighted}$

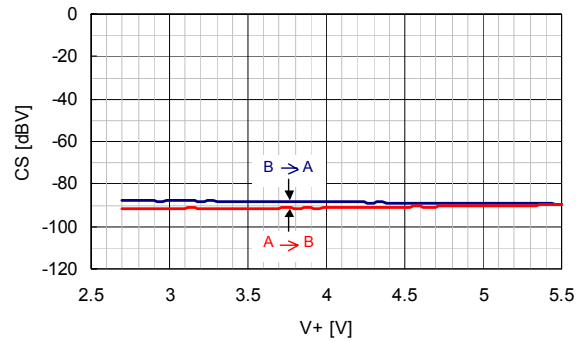

Channel Separation vs. EVR Control Voltage
 $V+ = 3.5V, V_{in} = -50dBV, f = 1kHz, T_a = 25^\circ C, A\text{-Weighted}$

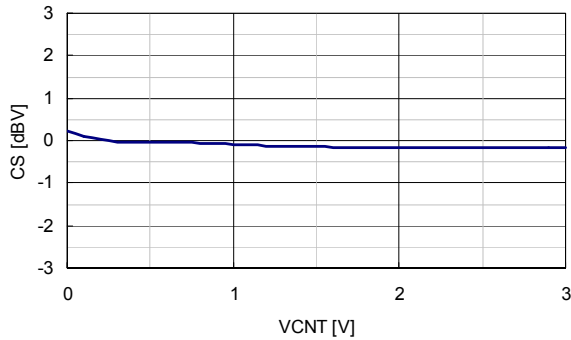

EVR Deviation vs. Supply Voltage
 $VCNT = 2.7V, V_{in} = -50dBV, f = 1kHz, T_a = 25^\circ C, A\text{-Weighted}$

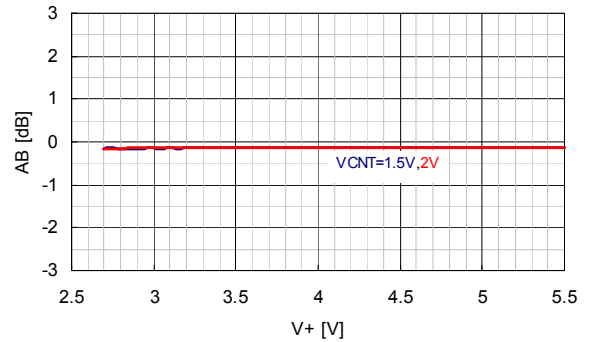

EVR Deviation vs. Frequency
 $VCNT = 2.7V, V_{in} = -50dBV, T_a = 25^\circ C$

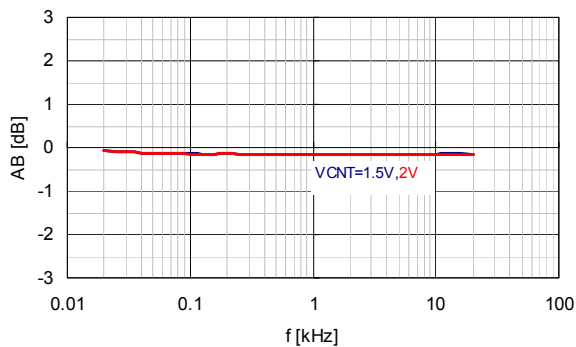

EVR Deviation vs. Temperature
 $V+ = 3.5V, V_{in} = -50dBV, f = 1kHz, VCNT = 2.7V, A\text{-Weighted}$

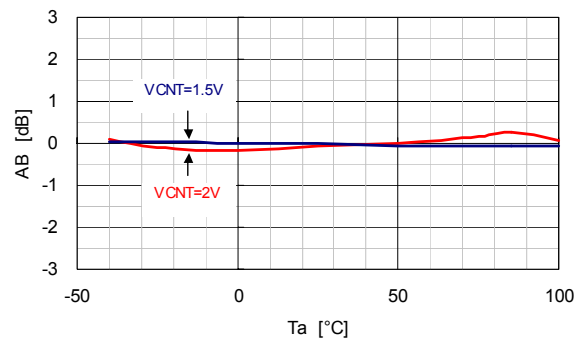

[CAUTION]

The specifications on this databook are only given for information, without any guarantee as regards either mistakes or omissions. The application circuits in this databook are described only to show representative usages of the product and not intended for the guarantee or permission of any right including the industrial rights.