

Features

- Input Voltage Range : 1.2V to 5.5V
- 20 μ A Ground Current (I_Q) at no Load
- PSRR = 75dB at 1kHz
- 1.5% Output Accuracy
- Low (0.1 μ A) Shutdown Current
- Dropout Voltage : 0.17V at 300mA when V_{OUT} \geq 3V
- Support Fixed Output Voltage 0.8V, 1.0V, 1.05V, 1.1V, 1.2V, 1.25V, 1.3V, 1.5V, 1.8V, 1.85V, 2V, 2.5V, 2.8V, 2.85V, 3V, 3.1V, 3.3V, 3.45V
- Current Limit Protection
- Over Temperature Protection
- Output Active Discharge Function
- SOT353 Packages

Applications

- CDM/GSM mobile phone
- PDAs /MP3
- Audio/Video equipment

General Description

This production is a low-dropout (LDO) voltage regulator with enable function that operates from a 1.2V to 5.5V supply. It provides up to 300mA of output current in miniaturized packaging.

The feature of 20 μ A low quiescent current and 0.5 μ A shutdown current are ideal for the battery application with long service life. The other features include current limit function, over temperature protection and output discharge function.

Ordering Information

TP6211C33R5G

Package Type
R5G=SOT353

Output Voltage:33=3.3V
30=3.0V
28=2.8V
18=1.8V
xx.xV

Pin Configuration

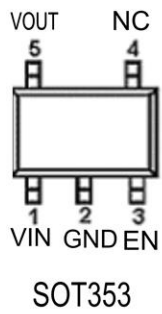

Pin No	Pin Name	Pin Function
1	VIN	Input of Supply Voltage.
2	GND	Ground
3	EN	Enable Control Input.
4	NC	No Internal Connection.
5	VOUT	Output of the Regulator

BLOCK DIAGRAM

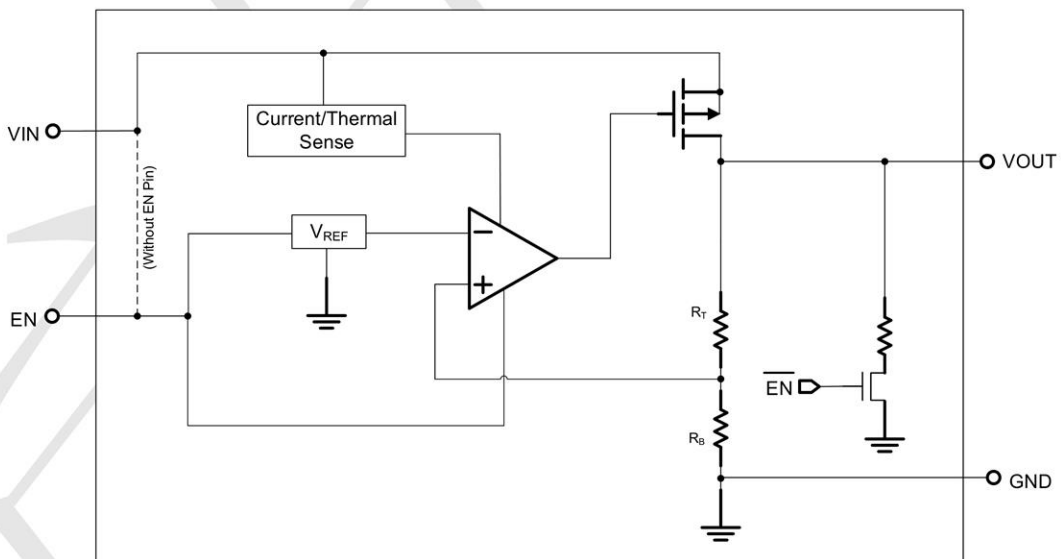

ABSOLUTE MAXIMUM RATINGS

VIN Pin to GND Pin Voltage	-0.3V to 6.5V
VOUT Pin and EN Pin to GND Pin Voltage	-0.3V to 6V
VOUT Pin to VIN Pin Voltage	-6V to 0.3V
Storage Temperature Range	-60°C~150°C
Lead Temperature (Soldering, 10 sec)	260°C
Junction Temperature	150°C
Operating Ambient Temperature Range T _A	-40°C~85°C
Thermal Resistance Junction to Ambient, R _{θJA} SOT353.....	330 °C/W

Electrical Characteristics (T = 25°C unless otherwise noted)

(V_{OUT} + 1 < V_{IN} < 5.5V, T_A = 25°C, unless otherwise specified)

Parameter	Symbol	Test Conditions	Min	Typ	Max	Unit
Fixed Output Voltage Range	V _{OUT}		0.8	--	3.45	V
DC Output Accuracy		I _{LOAD} = 1mA	-2	--	2	%
Dropout Voltage (I _{LOAD} = 300mA) (Note 5)	V _{DROP}	0.8V ≤ V _{OUT} < 1.05V	--	0.7	0.97	V
		1.05V ≤ V _{OUT} < 1.2V	--	0.5	0.92	
		1.2V ≤ V _{OUT} < 1.5V	--	0.4	0.57	
		1.5V ≤ V _{OUT} < 1.8V	--	0.3	0.47	
		1.8V ≤ V _{OUT} < 2.1V	--	0.24	0.33	
		2.1V ≤ V _{OUT} < 2.5V	--	0.21	0.3	
		2.5V ≤ V _{OUT} < 2.8V	--	0.18	0.25	
		2.8V ≤ V _{OUT} < 3V	--	0.16	0.23	
Dropout Voltage (I _{LOAD} = 200mA) (Note 6)	V _{DROP}	1.8V ≤ V _{OUT} < 2.1V	--	0.16	0.2	V
V _{CC} Consumption Current	I _Q	I _{LOAD} = 0mA, V _{OUT} ≤ 5.5V V _{IN} ≥ V _{OUT} + V _{DROP}	--	20		μA

Parameter	Symbol	Test Conditions	Min	Typ	Max	Unit	
Shutdown GND Current (Note 7)		V _{EN} = 0V	--	0.1	0.5	μA	
Shutdown Leakage Current (Note 7)		V _{EN} = 0V, V _{OUT} = 0V	--	0.1	0.5	μA	
EN Input Current	I _{EN}	V _{EN} = 5.5V	--	--	0.1	μA	
Line Regulation	ΔLINE	I _{LOAD} = 1mA	1.2V ≤ V _{IN} < 1.5V	--	0.3	0.6	%
			1.5V ≤ V _{IN} < 1.8V	--	0.15	0.3	
			1.8V ≤ V _{IN} ≤ 5.5V	--	0.13	0.35	
Load Regulation	ΔLOAD	1mA < I _{LOAD} < 300mA	--	0.5	1	%	
Power Supply Rejection Ratio	PSRR	V _{IN} = 3V, I _{LOAD} = 50mA, C _{OUT} = 1μF, V _{OUT} = 2.5V, f = 1kHz	--	75	--	dB	
Output Voltage Noise		C _{OUT} = 1μF, I _{LOAD} = 150mA, BW = 10Hz to 100kHz, V _{IN} = V _{OUT} + 1V	V _{OUT} = 0.8V	--	38	--	μV _{RMS}
			V _{OUT} = 1.2V	--	46	--	
			V _{OUT} = 1.8V	--	48	--	
			V _{OUT} = 3.3V	--	51	--	
Output Current Limit	I _{LIM}	V _{OUT} = 90% of V _{OUT(NOM)}	350	600	--	mA	
Enable Threshold Voltage	H-Level	V _{ENH}	V _{IN} = 5V	0.5	0.7	0.9	V
	L-Level	V _{ENL}	V _{IN} = 5V	0.4	0.65	0.85	
Thermal Shutdown Temperature	T _{SD}	I _{LOAD} = 30mA, V _{IN} ≥ 1.5V	--	150	--	°C	
Thermal Shutdown Hysteresis	ΔT _{SD}		--	20	--	°C	
Discharge Resistance		EN = 0V, V _{OUT} = 0.1V	--	80	--	Ω	

TYPICAL APPLICATION

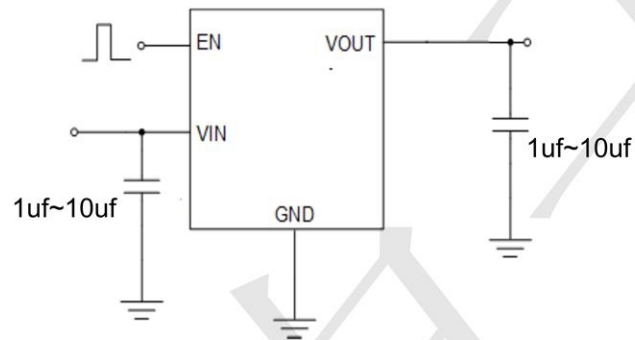
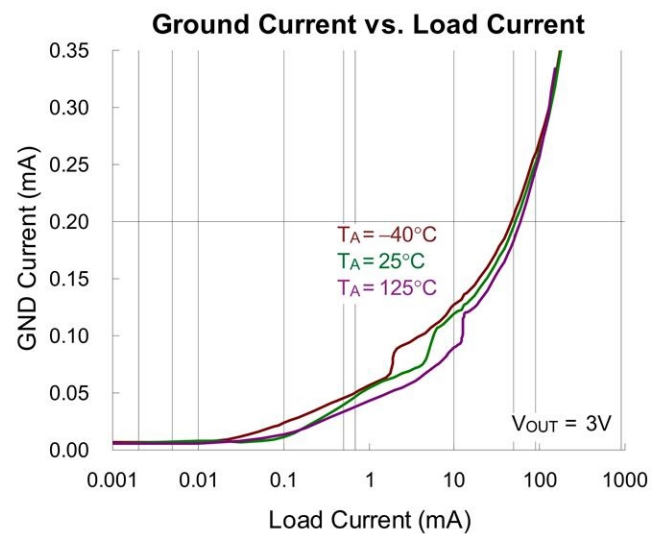
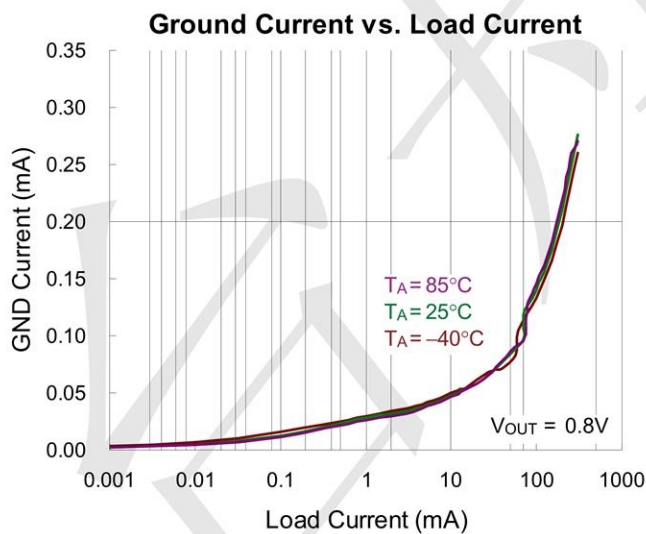
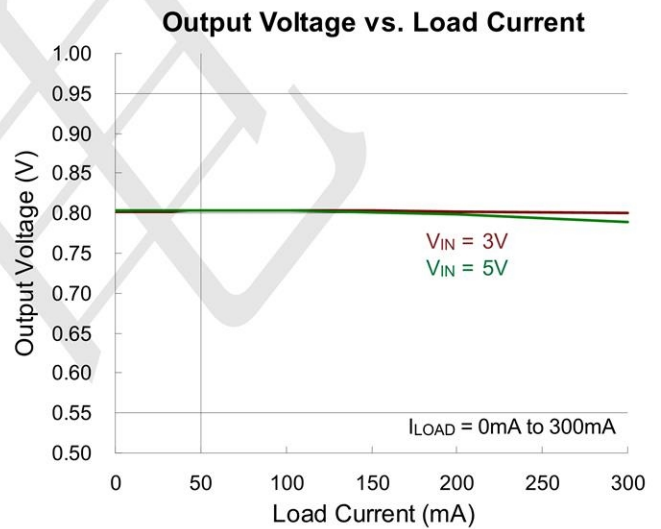
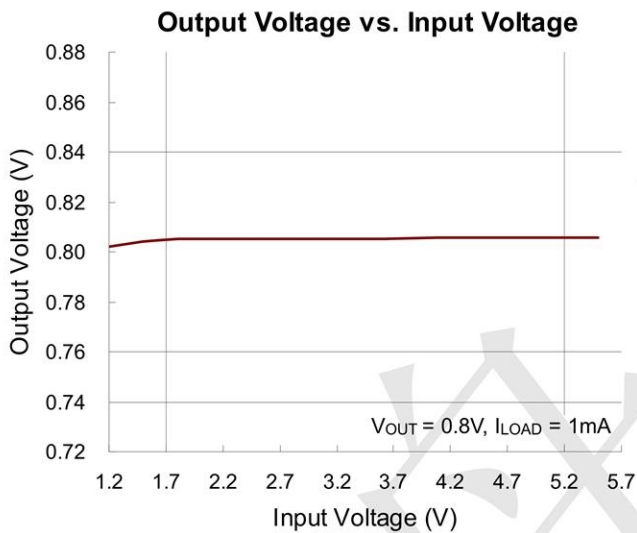
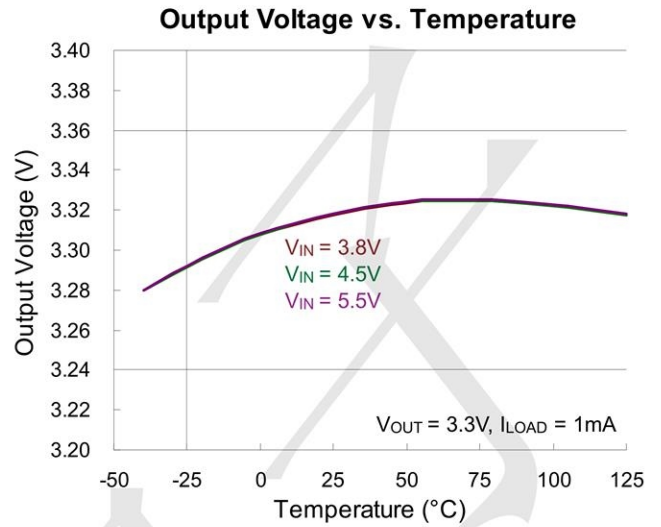
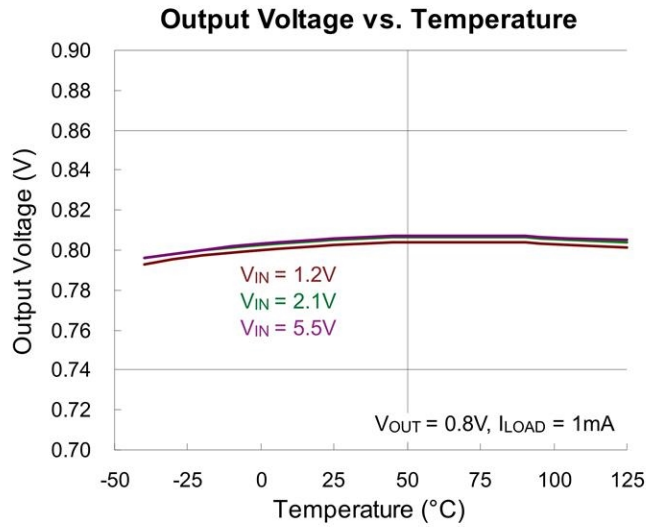
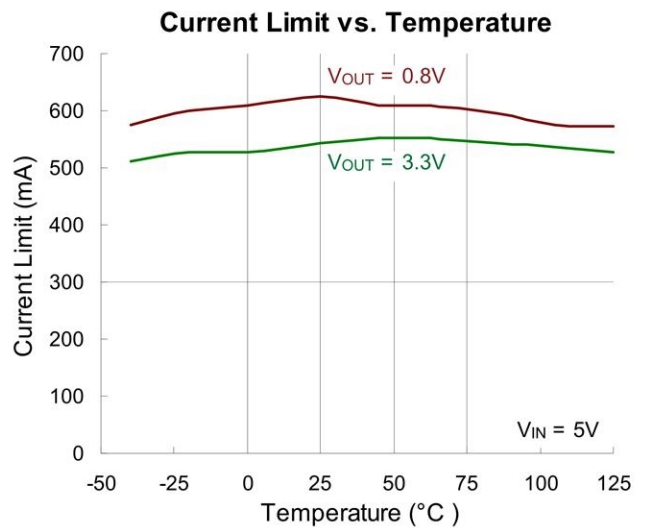
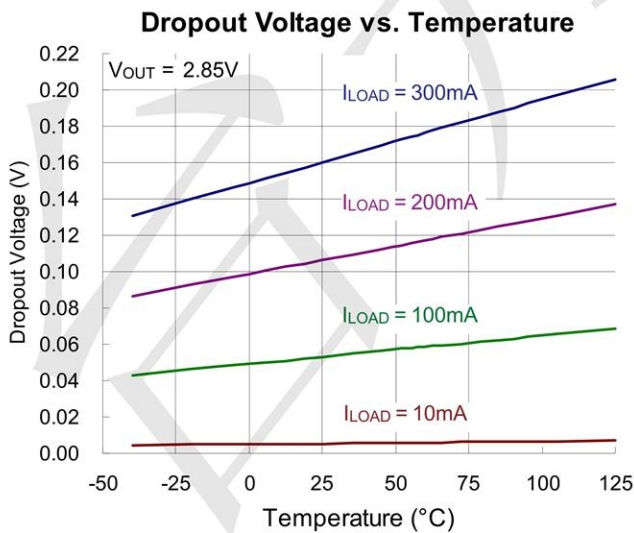
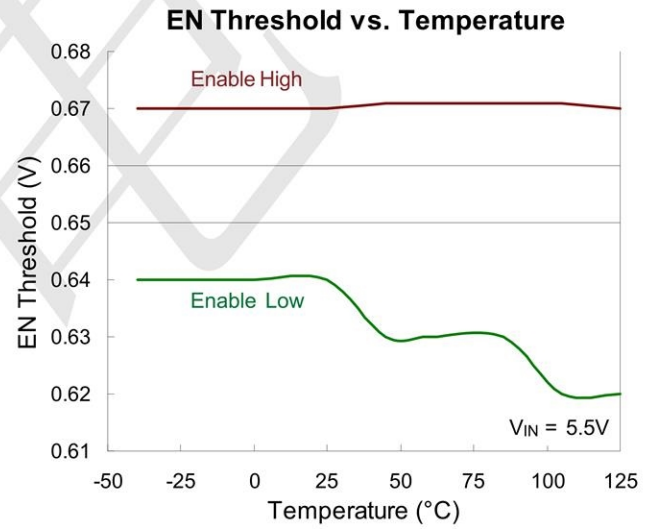
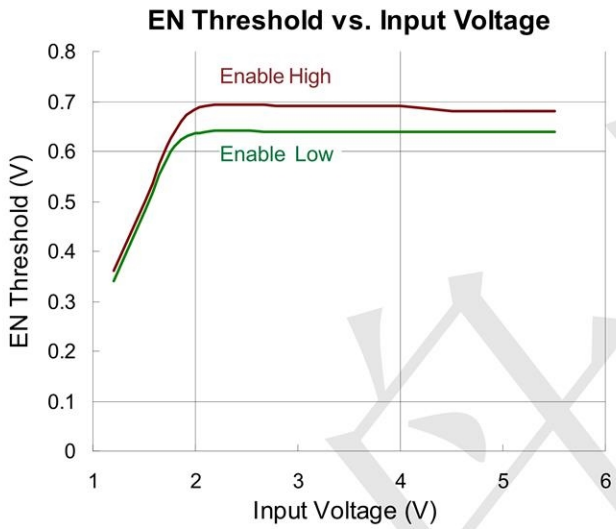
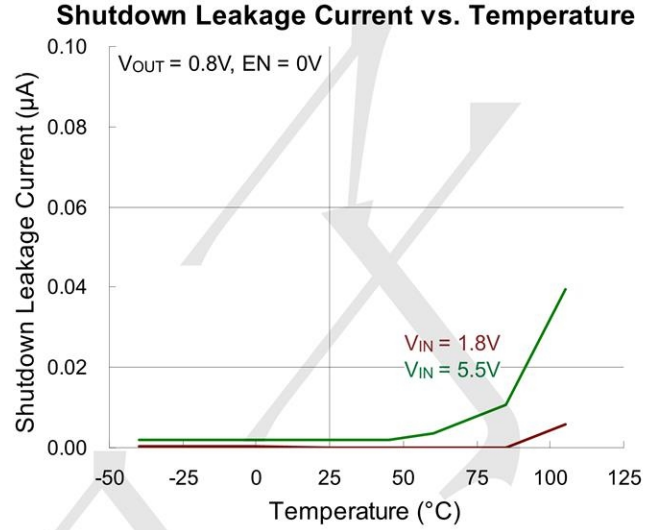
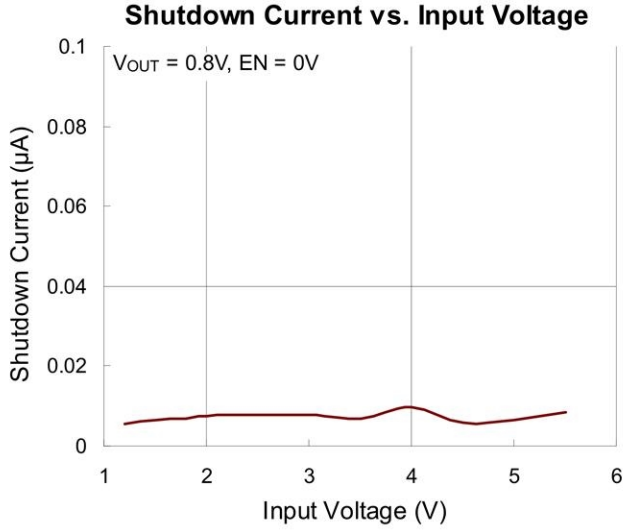

Figure 2: Application circuit of Fixed V_{OUT} LDO with enable function

Typical Operating Characteristics





Fold-Back Current Limit vs. Temperature

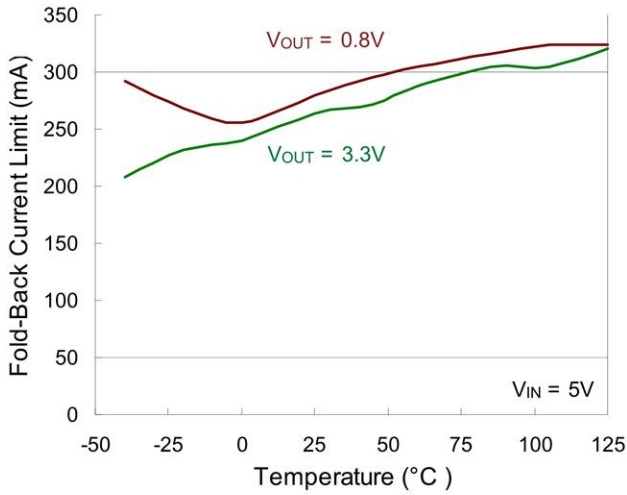

SNS Input Current vs. Temperature

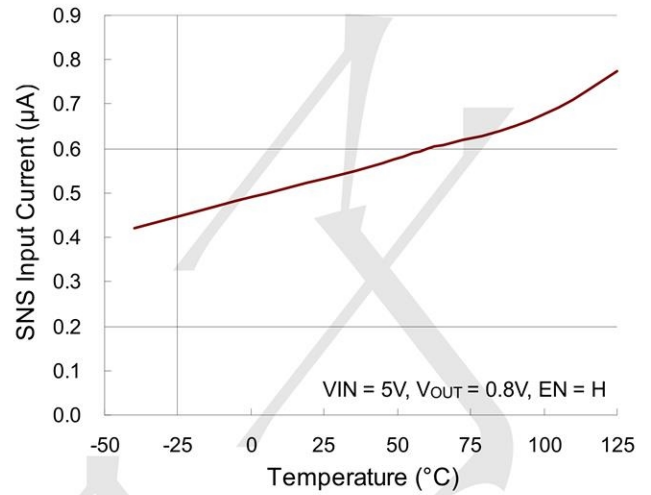

Power On from EN

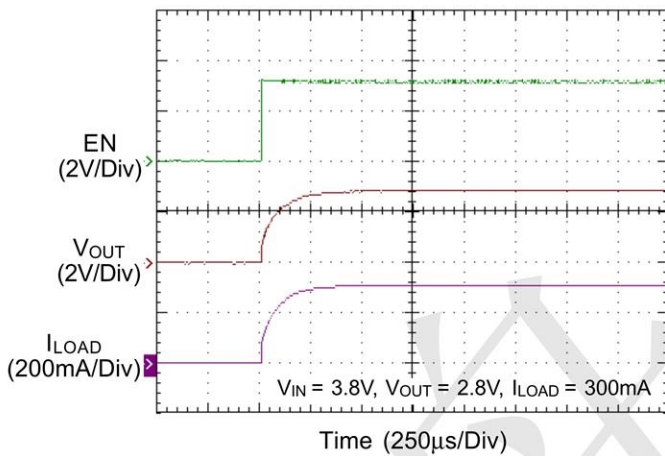

Power Off from EN

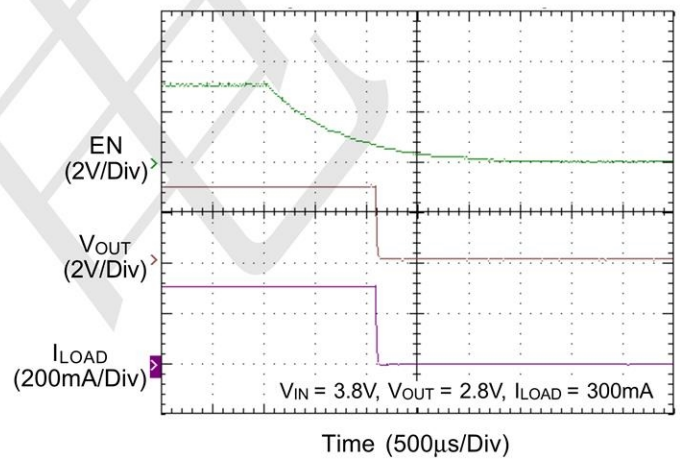

Line Transient

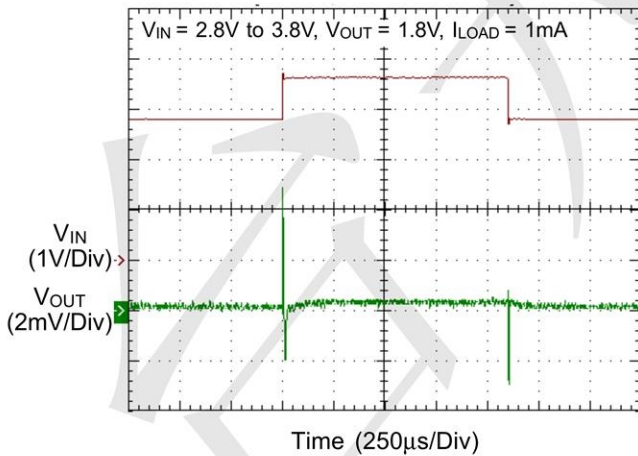

Load Transient

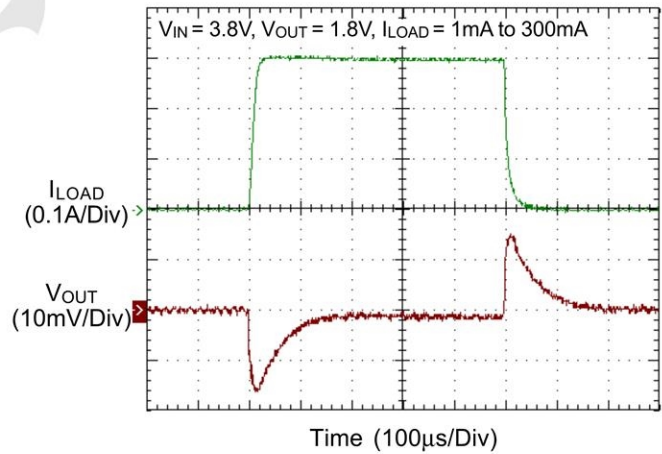

Output Current Limit Protection

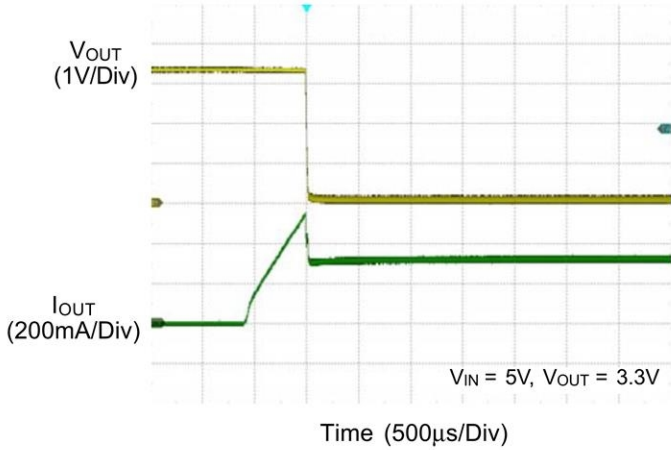

PSRR vs. Frequency

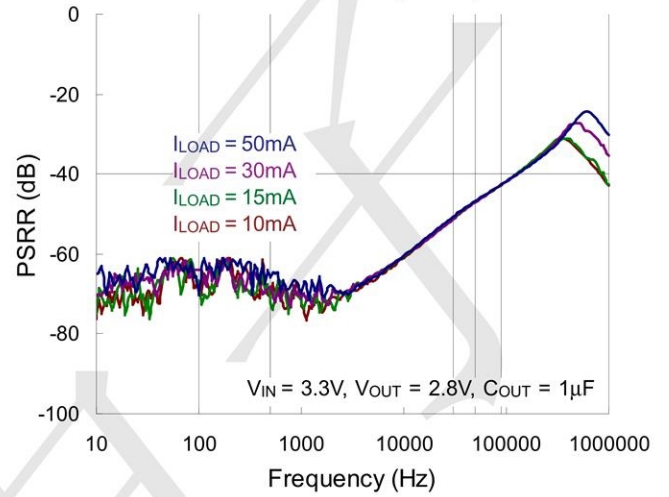

PSRR vs. Frequency

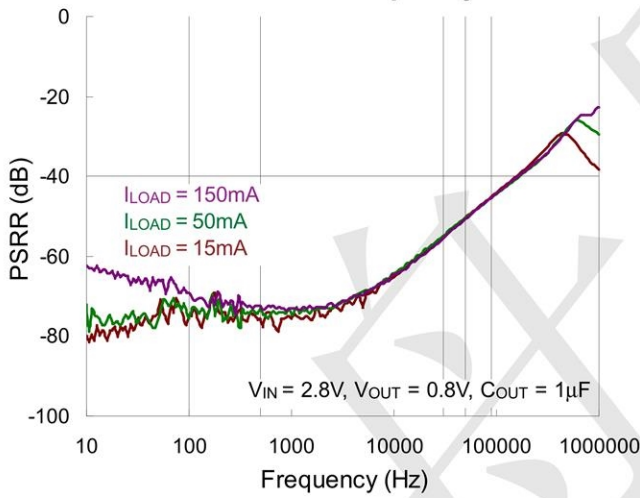

Output Noise vs. Frequency

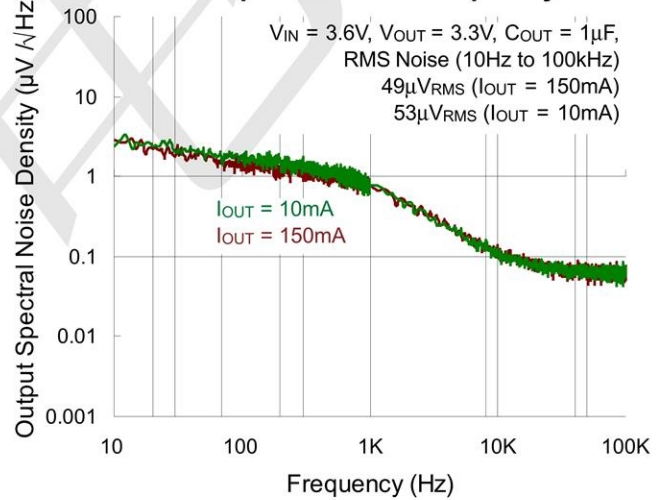

Package information

SOT353

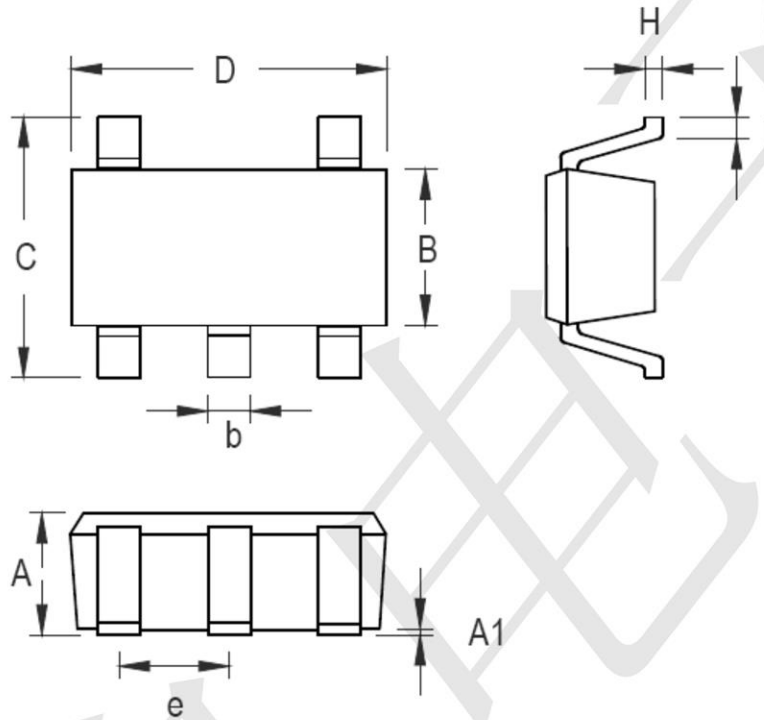

Symbol	Dimensions In Millimeters		Dimensions In Inches	
	Min	Max	Min	Max
A	0.800	1.100	0.031	0.044
A1	0.000	0.100	0.000	0.004
B	1.150	1.350	0.045	0.054
b	0.150	0.400	0.006	0.016
C	1.800	2.450	0.071	0.096
D	1.800	2.250	0.071	0.089
e	0.650		0.026	
H	0.080	0.260	0.003	0.010
L	0.210	0.460	0.008	0.018