

Main Features

- The control integrated circuit and the LED share the only power source.
- Control circuit and RGB chip are integrated in a package of 2020 components, to form a complete addressable pixel
- Built-in signal reshaping circuit, after wave reshaping to the next driver, ensure wave-form distortion not accumulate.
- Built-in electric reset circuit and power lost reset circuit.
- Each pixel of the three primary color can achieve 256 brightness display, completed 16777216 color full color display and scan frequency is of **2KHz**.
- Cascading port transmission signal by single line.
- When the refresh rate is 30fps, cascade number are not less than 1024 pixels.
- Send data at speeds of 800Kbps.
- **The color of the light adopts LED display's standard 3:6:1.**
- **White color temperature: 7000K-8000K**

Main Applications

- Transparent led screen, LED pixel screen, LED special shaped screen, all kinds of electrical products.

General description

WS2813C-2020 is an intelligent control LED light source, its exterior adopts the latest MOLDING packaging technology, the control circuit and RGB chips are integrated in a package of 2020 component.

Its internal includes intelligent digital port data latch and signal reshaping amplification drive circuit. Also include a precision internal oscillator and a voltage programmable constant current control part, effectively ensuring the pixel point light color height consistent.

Dual-signal wires version, signal break-point continuous transmission. Any pixel's failure won't affect signal transfer and total emitting effect.

The data transfer protocol use single NZR communication mode. After the pixel power-on reset, the DIN port receive data from controller, the first pixel collect initial 24bit data then sent to the internal data latch, the other data which reshaping by the internal signal reshaping amplification circuit sent to the next cascade pixel through the DO port. After transmission for each pixel, the signal to reduce 24bit. pixel adopt auto reshaping transmit technology, making the pixel cascade number is not limited the signal transmission, only depend on the speed of signal transmission.

RESET time >280μs, it won't cause wrong reset while interruption, it supports the lower frequency and inexpensive MCU. Refresh Frequency updates to **2KHz**, Low Frame Frequency and No Flicker appear in HD Video Camera, it improve excellent display effect. LED with low driving voltage, environmental protection and energy saving, high brightness, large scattering angle, good consistency, low power, long life and other advantages. The control chip integrated in LED above becoming more simple circuit, small volume, convenient installation.

Mechanical Dimensions (unit:mm)

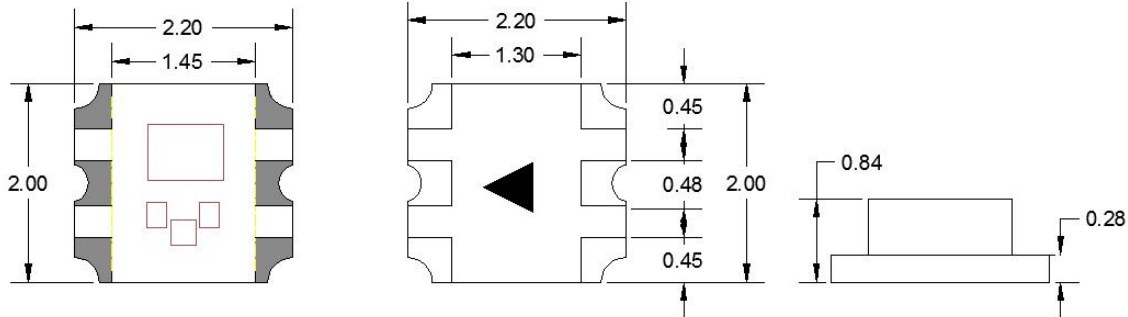

PIN Configuration

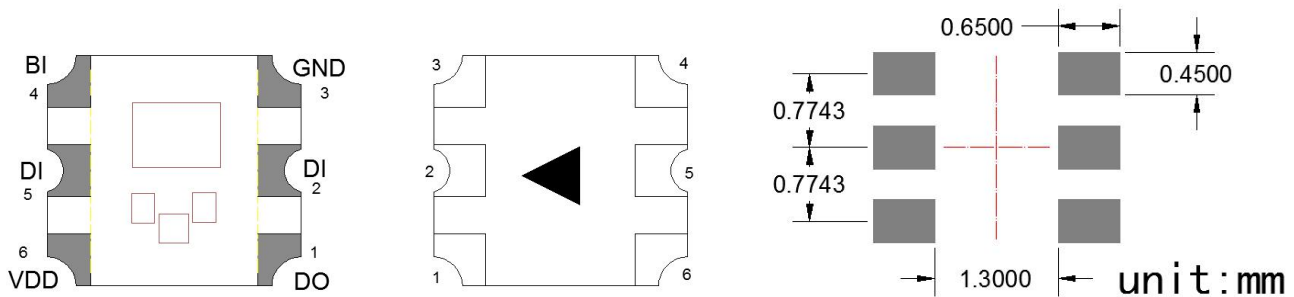

Recommend PCB package dimension

PIN Function

NO.	Symbol	PIN	Function description
1	DO	DATA OUT	Control data signal output
2、5	DI	DATA IN	Control data signal input
3	GND	GROUND	Data & Power Grounding
4	BI	BACKUP DATA IN	Backup data signal input
6	VDD	POWER SUPPLY	LED POWER SUPPLY, connect to “+5V”

Absolute Maximum Ratings (TA=25°C, VSS=0V, unless otherwise specified)

Parameter	Symbol	Ratings	Unit
Power supply voltage	V _{DD}	+3.7~+5.3	V
Logical Input Voltage	V _I	-0.3V~V _{DD} +0.7	V
Working Temperature	T _{opt}	-25~+85	°C
Storage Temperature	T _{stg}	-40~+105	°C

Electrical Characteristics (TA=25°C, VSS=0V, unless otherwise specified)

Parameter	Symbol	Min.	Typ.	Max.	Unit	Test Conditions
Input Pin Current	I _{sink}	—	20	—	mA	
Input Current	I _I	—	—	±1	μA	V _I =V _{DD} /V _{SS}
High-level Input	V _{IH}	2.7V	—	VDD+0.7V	V	D _{IN} , SET
Low-level Input	V _{IL}	-0.3V	—	0.7V	V	D _{IN} , SET

Switching Characteristics (TA=25°C, VSS=0V, unless otherwise specified)

Parameter	Symbol	Min.	Typ.	Max.	Unit	Condition
Transmission Delay Time	t _{PLZ}	—	—	300	ns	CL=15pF, DIN→DOUT, RL=10KΩ
Fall time	t _{THZ}	—	—	120	μs	CL=300pF, OUTR/OUTG/OUTB
Input-capacitance	C _I	—	—	15	pF	—

LED Characteristics

Parameter	Symbol	Color	Quiescent Current: <0.5mA			
			Min.	Typ.	Max.	Unit
Brightness	IV	Red	210	230	300	mcd
		Green	420	470	600	
		Blue	70	80	100	
Wavelength	λ _d	Red	620	623	625	nm
		Green	522	523	527	
		Blue	470	472	475	

Data Transfer Time

Symbol	Parameter Description	Min.	Typ.	Max.	Unit
T0H	0-code, High-level time	220	340	380	ns
T1H	1-code, High-level time	580	680	1000	ns
T0L	0-code, Low-level time	680	820	1200	ns
T1L	1-code, Low-level time	680	820	1200	ns
RES	Frame unit, Low-level time	280	-	-	us

Tips: T0L and T1L timing must be longer than LED's reshaping output's T1H (Test point is DO)

Timing simulation waveform

Sequence Chart:

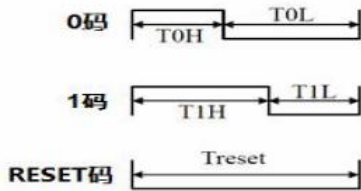

Cascade method:

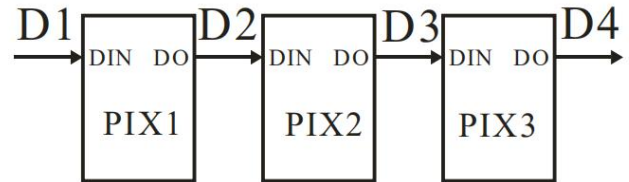

Data Transmission Method

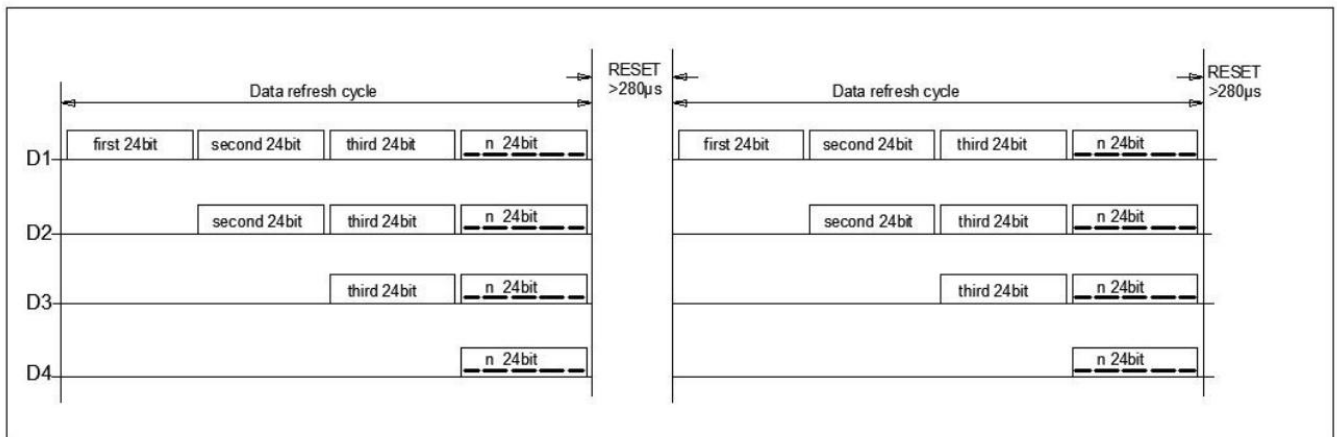

Note: The data of D1 is sent by MCU, D2, D3, D4 through pixel internal reshaping amplification to transmit.

Composition of 24bit data

G7	G6	G5	G4	G3	G1	G0	R7	R6	R5	R4	R3	R2	R1	R0	B7	B6	B5	B4	B3	B2	B1	B0
----	----	----	----	----	----	----	----	----	----	----	----	----	----	----	----	----	----	----	----	----	----	----

Note: Data transmit in order of GRB, high bit data at first.

Typical application circuit(IC internal integrated filter capacitor,no external components required).

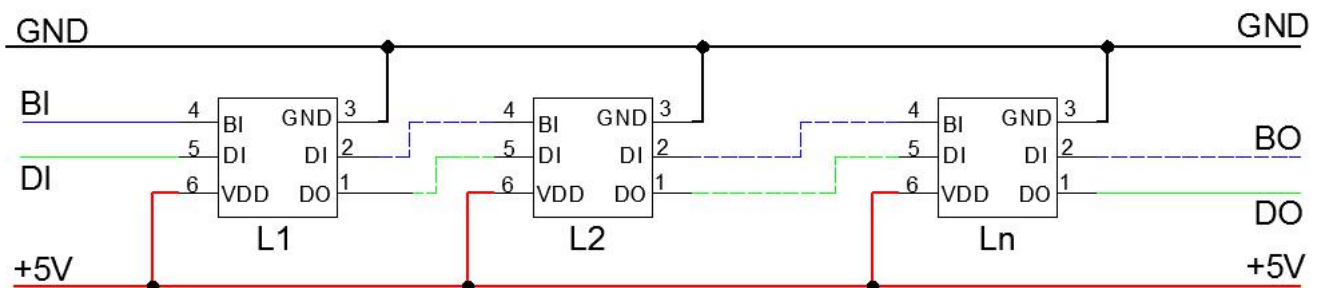

Remarks: NO extra components needed, even the capacitor.

Tape Size (Unit: mm)

Inspector:

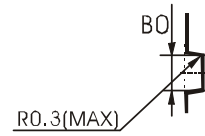
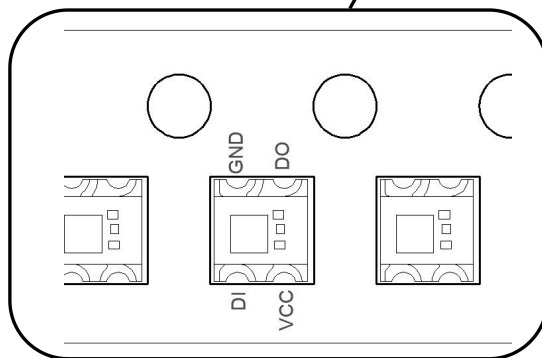
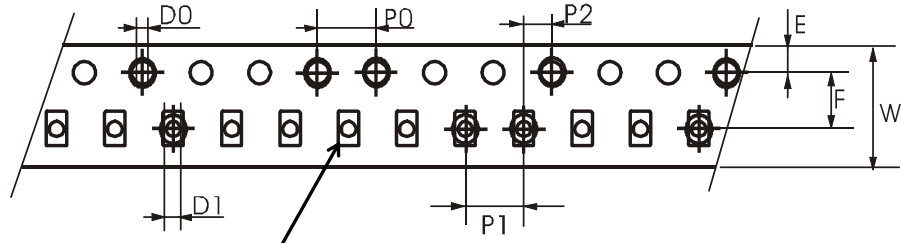

LED Tape Position

UNIT: mm

CARRIER TAPES TEST REPORTS

SYMBOL	A0	B0	K0	P0	P1	P2	T	E	F	D0	D1	W
SPEC	2.20	2.40	1.01	4.00	4.00	2.00	0.18	1.75	3.50	1.50	1.00	8.00

Reel Packing Specifications (Unit: mm)

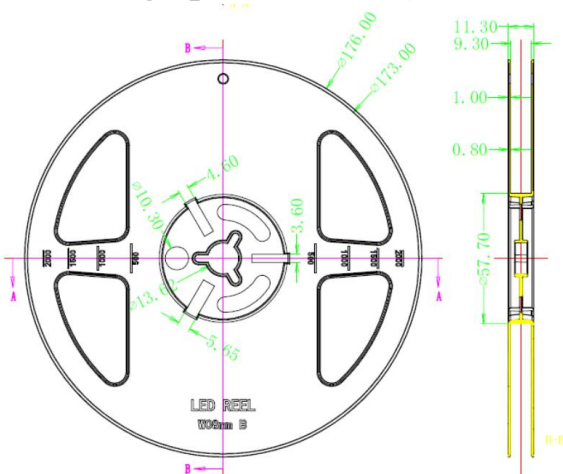

Anti-Moisture Vacuum bag packing

SPQ: 4500PCS /Reel

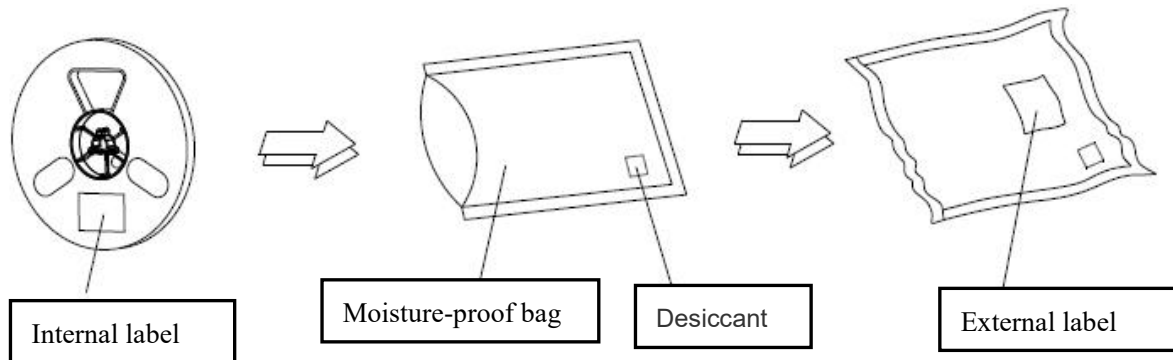

Instructions for using surface mounted LED

1. Description

LED is usually used in the same way as other electronic components. In order to let customers better use the LED products of WORLDSEMI, please refer to the following LED protection and prevention measures.

2. Attention

2.1 Dust and cleaning

LED's surface adopt the modified epoxy glue, epoxy can protect LED optical system and anti - aging performance.

But it is easy to stick dust, please keep the working environment clean..When there is a certain amount of dust on the LED surface, the luminance will not be affected, but we should still avoid dust falling on the LED surface.It is preferred to use the products whose packaging bag opened first, The PCBA should be stored in a clean container.

If the LED surface needs to clean,If triaminoethylene or acetone are used, the LED surface will be dissolved and so on,It is not allowed to clean LED with solvent solution. The LED can be cleaned with a solution of isopropyl.Before using any cleaning solution, confirm whether the LED will dissolve in advance.

Please do not use ultrasonic method to clean LED, if the product must use ultrasonic wave, then some parameters that affect LED, such as ultrasonic power, baking time and assembly conditions, must be evaluated before cleaning, to confirm whether LED will be affected

2.2 Moisture proof packaging

The TOP SMD LED is a wet sensor components,the LED is packaged in an aluminium film bag to prevent the LED from absorbing moisture during transportation and storage. A desiccant is placed in the bag to absorb moisture. If the

LED absorbs water vapor, the water vapor will evaporate and expand when the LED is reflow soldered, potentially detaching the glue from the support and damaging the LED's optical system. For this reason, moisture-proof packaging is designed to keep moisture out of the package.

The Moisture Sensitivity Level of this product is: **LEVEL5a**

Table-I: IPC/JEDEC J-STD-020 defined the material's Moisture Sensitivity Level(MSL)

Moisture Sensitivity Level	Lifespan at Workshop after opening packages	
	Time	Conditions
LEVEL1	Unlimited	≤30°C/85%RH
LEVEL2	1 Year	≤30°C/60%RH
LEVEL2a	4 Weeks	≤30°C/60%RH
LEVEL3	168 Hours	≤30°C/60%RH
LEVEL4	72 Hours	≤30°C/60%RH
LEVEL5	48 Hours	≤30°C/60%RH
LEVEL5a	24 Hours	≤30°C/60%RH
LEVEL6	Take out and use immediately	≤30°C/60%RH

2.3 Control method after products opening

1. Please use the LED under the condition of “T<30°C, RH<60%”.
2. Use up within 24 hours after removing from packages.
3. We would recommend to do dehumidification if they exceed the valid storage period of products or dampened due to other reasons.

2.4 Baking conditions before SMT(No leakage in the package): Rebaking temperature: 70°C-75°C/>24H.

4. Reflow Soldering

Refer to the parameters listed below, the experimental results prove that the TOP SMD LED meets the JEDEC J-STD-020C standards. As a general guideline, it is recommended to follow the SMT reflow temperature curve recommended by the solder paste manufacturer.

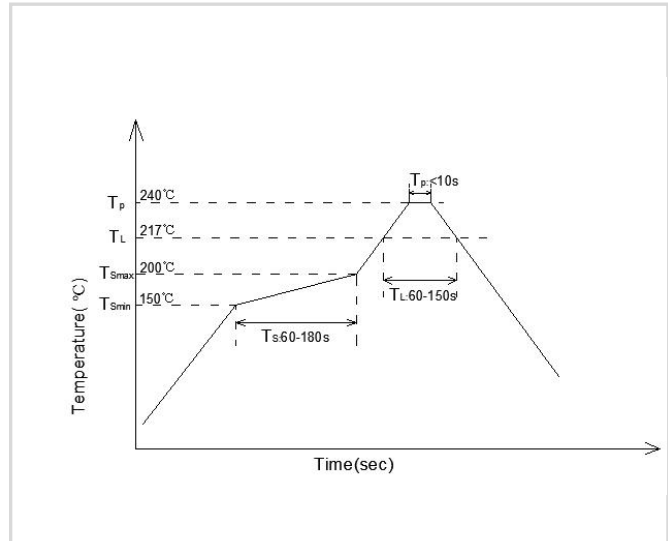

Curve Description	Lead-free
The lowest preheat temperature (T _{sm})	150°C
The highest preheat temperature (T _{sm})	200°C
Preheating time (T _{sm} to T _{sm}) (ts)	60-180 S
Average rate of temperature rise (T _{sm} to T _p)	<3°C/S
LIQUID REGION temperature (T _L)	217°C
LIQUID REGION Holding Time (t _L)	60-150 S
Peak Temperature (T _p)	240°C
High Temperature Region(T _p -5°C) Holding	<10 S
Cooling Rate	<6°C/S
Room Temperature to Peak Holding Time	<6 min



Remarks: 1. These general guidelines may not apply to all PCB designs and reflow soldering configurations.

2. All temperatures referred are measured on the surface of the package body.

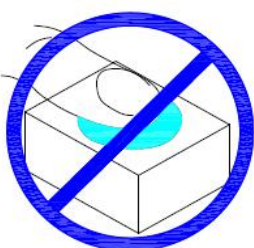
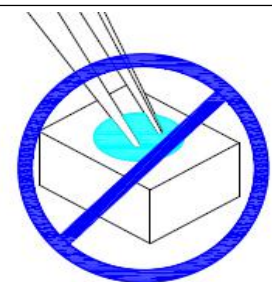
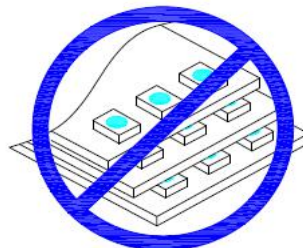
5. Assembly process attentions

1. Clip the LED from its side.	2. Neither directly touch the gel surface with the hand or sharp instrument, it may damage its internal circuit.	3. Not to be double stacked, it may damage its internal circuit.	4. Can not be stored in or applied in the acidic sites of PH<7.
			

6. Modify Records

Version №	Status Bar	Modify Content Summary	Date	Reviser	Approved
V1.0	N	New	20190701	Shen JinGuo	Yin HuaPing
V1.1	M	Adjust brightness and timing parameters, add PCB package dimension image	20190912	Shen JinGuo	Yin HuaPing

V1.2	M	Modify PIN definition and internal layout.	20190928	Shen JinGuo	Yin HuaPing
------	---	--	----------	-------------	-------------

Remarks: Initial version: V1.0; Version number plus "0.1" after each revision;

Status bar: N--New, A--Add, M--Modify, D--Delete.