

## General Description

The LTP829 is low noise, LDO Voltage Regulators with enable function that output voltages of 3.3 V, 5 V. These characteristics, combined with low noise and good PSRR with low dropout voltage, make this device ideal for portable consumer applications. The LTP829 can operate with up to 20 V input. The Devices are available in SOT-223, ESOP-8, DFN2×2-6, DFN3×3-8 and SOT89-3.

## Features

- Wide Input Voltage Range: up to 20 V
- Max Output Current: 1 A
- Output Voltage Accuracy:  $\pm 2\%$
- Adjustable Output Voltage Options:  $V_{FB} = 0.64 \text{ V}$
- Fixed Output Voltage: from 3.3 V, 5 V
- Other Output Voltage Options Available on Request
- Standby Current: 160  $\mu\text{A}$  (Typical)
- Dropout Voltage: 0.5 V at 1A when  $V_{OUT} \geq 2 \text{ V}$
- High Ripple Rejection: 80 dB at 1 kHz
- Available Packages: SOT-223, ESOP-8, SOT89-3, DFN2×2-6, DFN3×3-8

## Applications

- Consumer and Industrial Equipment Point of Regulation
- Switching Power Supply Post Regulation
- Battery Chargers
- Hard Drive Controllers

## Order Information

Model	Package	Ordering Number <sup>Note1</sup>	Packing Option
LTP829	SOT223	LTP829-xxXT3	Tape and Reel, 2500
	DFN2×2-6	LTP829-ADJF6	Tape and Reel, 3000
	DFN3×3-8	LTP829-ADJF8	Tape and Reel, 3000
	ESOP-8	LTP829-ADJS8	Tape and Reel, 4000
	SOT89-3	LTP829-xxXT4	Tape and Reel, 1000

Note: xx stands for output voltage, e.g. if xx = 18, the output voltage is 1.8 V; if xx = 30, the output voltage is 3.0 V. Adjustable Output Voltage, Rang: 0.6 V to 3.6 V.

### Pin Configuration (Top View)

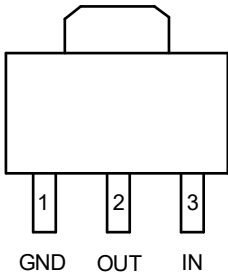

SOT-223

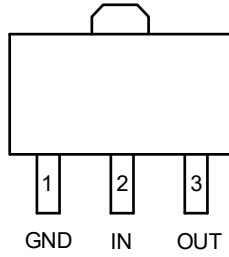

SOT89-3

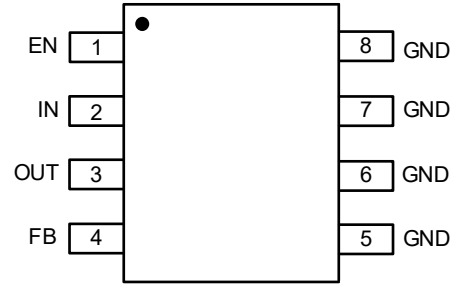

ESOP-8

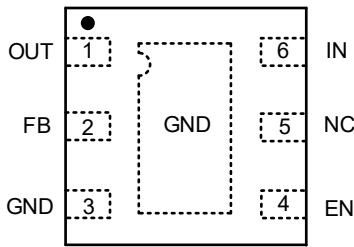

DFN2×2-6

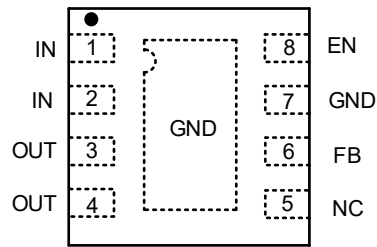

DFN3×3-8

### Pin Function

Package					Symbol	Function
SOT-223	DFN2×2-6	DFN3×3-8	SOT89-3	ESOP-8		
1	3	7	1	5,6,7,8	GND	Ground.
2	1	3, 4	3	3	OUT	Output pin.
3	6	1, 2	2	2	IN	Power supply input pin.
	4	8		1	EN	Enable pin.
	2	6		4	FB	This pin is used as an input to the control loop error amplifier and is used to set the output voltage of the LDO.
	5	5			NC	Not connect.
	Exposed Pad	Exposed Pad		Exposed Pad	GND	Exposed thermal pad. Connect to GND for best thermal performance.

CAUTION: These devices are sensitive to electrostatic discharge; follow proper IC Handling Procedures.  
 Linearin and designs are registered trademarks of Linearin Technology Corporation.  
 ©Copyright Linearin Technology Corporation. All Rights Reserved.  
 All other trademarks mentioned are the property of their respective owners.

## Block Diagram

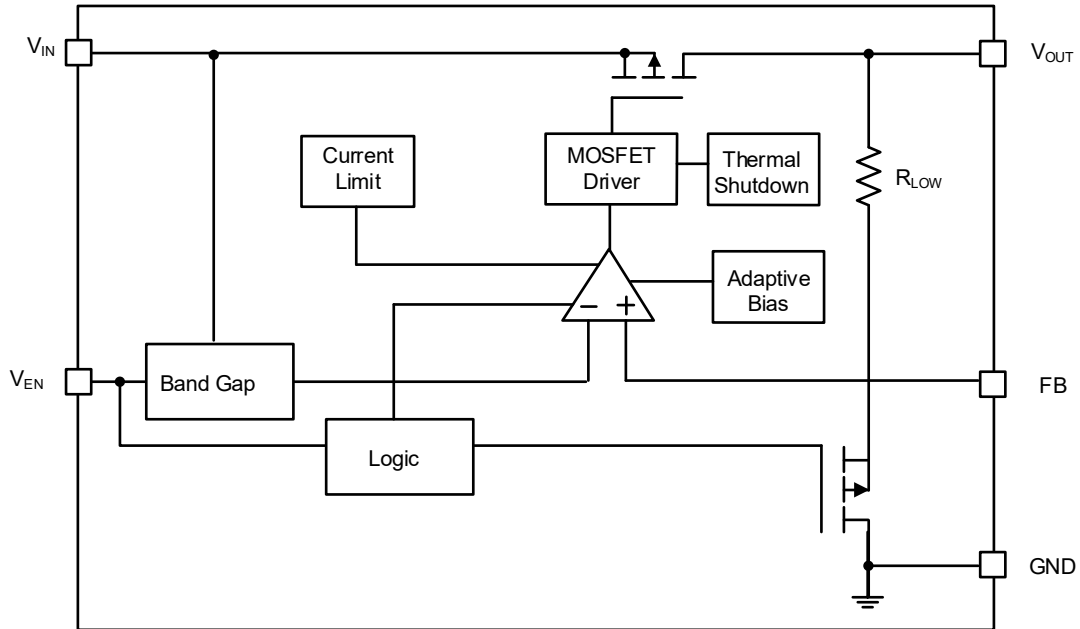

## Functional Description

### Enable

The LTP829 delivers the output power when it is set to enable state. When it works in disable state, there is no output power and the operation quiescent current is almost zero. The enable pin (EN) is active high.

### Shutdown

Turn off the device by forcing the EN pin to drop below  $V_{EN(LO)}$ . If shutdown capability is not required, connect EN to IN. The LTP829 has an internal pulldown MOSFET that connects an  $R_{PULLDOWN}$  resistor to ground when the device is disabled. The discharge time after disabling depends on the output capacitance ( $C_{OUT}$ ) and the load resistance ( $R_L$ ) in parallel with the pulldown resistor ( $R_{PULLDOWN}$ ). Formula 1 calculates the time constant:

$$\tau = (R_{PULLDOWN} \times R_L) / (R_{PULLDOWN} + R_L) \quad (1)$$

### Over-Temperature Protection

The over-temperature protection function will turn off the P-MOSFET when the junction temperature exceeds 150°C (typical). Once the junction temperature cools down by approximately 20°C the regulator will automatically resume operation.

### Current-Limit Protection

The LTP829 provides current limit function to prevent the device from damages during over-load or shorted-circuit condition. This current is detected by an internal sensing transistor.

## Recommended Operating Condition

Parameter	Symbol	Rating	Unit
Input Voltage	$V_{IN}$	up to 20	V
Output Current	$I_{OUT}$	0 to 1	A
Operating Ambient Temperature	$T_A$	-40 to 85	°C
Effective Input Ceramic Capacitor Value <sup>(1)</sup>	$C_{IN}$	1 to 10	μF
Effective Output Ceramic Capacitor Value <sup>(1)</sup>	$C_{OUT}$	1 to 10	μF
Input and output Capacitor Equivalent Series Resistance(ESR)	ESR	5 to 100	mΩ

Notes: (1) The capacitor is a chip capacitor, and larger capacitance value is required if electrolytic capacitor is used.

## Absolute Maximum Ratings

Parameter	Rating	Unit	
IN pin to GND pin <sup>(1)</sup>	-0.3 to 24	V	
OUT pin to GND pin	0.65 to 6	V	
Chip Enable Input	-0.3 to 22	V	
Maximum Junction Temperature	150	°C	
Storage Temperature	-65 to 150	°C	
ESD (HBM mode)	HBM <sup>(2)</sup>	±2000	V
	CDM <sup>(2)</sup>	±1500	
Latch up Current Maximum Rating <sup>(3)</sup>	200	mA	
Thermal Resistance (Junction to Ambient) <sup>(4)</sup>	SOT223	80	°C/W
	SOT89-3	120	
	ESOP-8	60	
	DFN2×2-6	105	
	DFN3×3-8	65	

### Notes:

Stresses beyond those listed under "ABSOLUTE MAXIMUM RATINGS" may cause permanent damage to the device. These are stress ratings only, and functional operation of the device at these or any other conditions beyond those indicated in the operational sections of the specifications is not implied. Exposure to absolute maximum rating conditions for extended periods may affect device reliability.

(1) Refer to ELECTRICAL CHARACTERISTICS and APPLICATION INFORMATION for Safe Operating Area.

(2) This device series incorporates ESD protection and is tested by the following methods: ESD Human Body Model tested per EIA/JESD22-A114. CDM tested per JESD22-C101.

(3) Latch up Current Maximum Rating tested per JEDEC78.

(4) This particular frame decreases the total thermal resistance of the package and increases its ability to dissipate power when an appropriate area of copper on the printed circuit board is available for heat-sinking.

## Caution

This integrated circuit can be damaged by ESD if you don't pay attention to ESD protection. LINEARIN recommends that all integrated circuits be handled with appropriate precautions. Failure to observe proper handling and installation procedures can cause damage. ESD damage can range from subtle performance degradation to complete device failure. Precision integrated circuits may be more susceptible to damage because very small parametric changes could cause the device not to meet its published specifications.

LINEARIN reserves the right to make any change in circuit design, specification or other related things if necessary without notice at any time. Please contact LINEARIN sales office to get the latest datasheet.

## Electrical Characteristics

( $V_{IN} = V_{OUT} + 1\text{ V}$ ,  $I_{OUT} = 10\text{ mA}$ ,  $T_A = 25^\circ\text{C}$ ,  $C_{IN} = C_{OUT} = 1.0\text{ }\mu\text{F}$ , unless otherwise noted)

Parameter	Symbol	Test Conditions	Min.	Typ.	Max.	Unit	
Input Voltage Operation Range	$V_{IN}^{(1)}$				20	V	
Output Voltage	$V_{OUT}$	$T_A = 25^\circ\text{C}$	-2%		+2%	V	
		$-40^\circ\text{C} \leq T_A \leq 85^\circ\text{C}$	-3%		+3%		
Reference Voltage	$V_{FB}$	$T_A = 25^\circ\text{C}$		0.64		V	
Line Regulation	$R_{egLINE}$	$2.5\text{ V} \leq V_{IN} \leq 20\text{ V}$ , $I_{OUT} = 10\text{ mA}$		0.05	0.2	% $V_{OUT}$	
Dropout Voltage	$V_{DROP}^{(3)}$	$V_{IN} \geq 2.5\text{ V}$ $I_{OUT} = 1\text{ A}$	$0.65\text{ V} \leq V_{OUT} < 1\text{ V}$			2500	mV
			$1\text{ V} \leq V_{OUT} < 1.5\text{ V}$			2000	
			$1.5\text{ V} \leq V_{OUT} < 2\text{ V}$			1000	
			$2\text{ V} \leq V_{OUT} < 2.5\text{ V}$			800	
			$2.5\text{ V} \leq V_{OUT} < 5.5\text{ V}$	450	598		
Load Regulation	$R_{egLOAD}$	$1\text{ mA} \leq I_{OUT} \leq 800\text{ mA}$ , $V_{IN} = V_{OUT} + 1\text{ V}$			40	mV	
Current Limit	$I_{LMT}$	$V_{IN} = V_{OUT} + 1\text{ V}$	1.04	1.3		A	
Short Circuit Current Limit	$I_{SHORT}$	$V_{OUT} = 0\text{ V}$	350			mA	
Quiescent Current	$I_Q$	$I_{OUT} = 0\text{ mA}$		160	190	$\mu\text{A}$	
Standby Current	$I_{Q,OFF}$	$V_{EN} = 0\text{ V}$ , $T_A = 25^\circ\text{C}$		0.1	1	$\mu\text{A}$	
EN Pin Threshold Voltage	$V_{ENH}$	EN Input Voltage "H"	1.2			V	
EN Pin Threshold Voltage	$V_{ENL}$	EN Input Voltage "L"			0.4	V	
EN Pin Current	$I_{EN}$	$V_{EN} \leq V_{IN} \leq 20\text{ V}$		1		$\mu\text{A}$	
Power Supply Rejection Ratio	PSRR	$V_{IN} = V_{OUT} + 1\text{ V}$ , $I_{OUT} = 50\text{ mA}$ ,	$f = 1\text{ kHz}$			80	dB
			$f = 100\text{ kHz}$			70	
			$f = 1\text{ MHz}$			65	
Active Output Discharge Resistance (A option only)	$R_{LOW}$	$V_{IN} = 4\text{ V}$ , $V_{EN} = 0\text{ V}$		70		$\Omega$	
Thermal Shutdown Temperature	$T_{SD}$	$V_{IN} = 4\text{ V}$ , $V_{EN} = 0\text{ V}$		150		$^\circ\text{C}$	
Thermal Shutdown Hysteresis	$T_{SDH}$	Increasing from $T_A = +25^\circ\text{C}^{(2)}$		25		$^\circ\text{C}$	
Output Noise Voltage	$e_N$	$V_{IN} = V_{OUT} + 1\text{ V}$ , $I_{OUT} = 1\text{ mA}$ , $f = 10\text{ Hz to } 100\text{ kHz}$ , $V_{OUT} = 3\text{ V}$ , $C_{OUT} = 1\text{ }\mu\text{F}^{(2)}$		60		$\mu\text{V}_{RMS}$	

### Notes:

(1) Here  $V_{IN}$  means internal circuit can work normal. If  $V_{IN} < V_{OUT}$ , Output voltage follow  $V_{IN}$  ( $I_{OUT} = 1\text{ mA}$ ), circuit is safety.

(2) Guaranteed by design and characterization. not a FT item.

(3)  $V_{DROP}$  FT test method: test the  $V_{OUT}$  voltage at  $V_{SET} + V_{DROP(MAX)}$  with 1A output current.

## Typical Performance Characteristics

Note: Typical Characteristics are intended to be used as reference data; they are not guaranteed.

### $T_{ON}$ and $T_{OFF}$

( $V_{IN} = V_{OUT} + 1\text{ V}$ ,  $I_{OUT} = 0\text{ mA}$ ,  $C_{IN} = C_{OUT} = 10\text{ }\mu\text{F}$ )

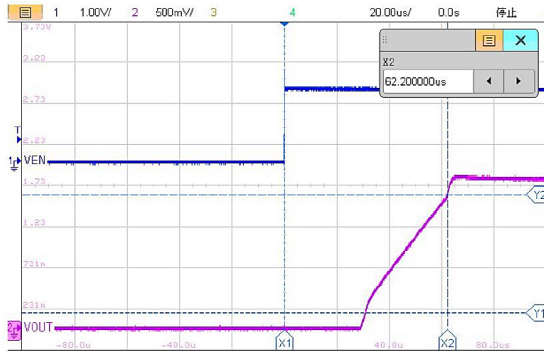

Turn On VS. EN Voltage ( $V_{OUT} = 1.8\text{ V}$ ,  $I_{OUT} = 0\text{ mA}$ )

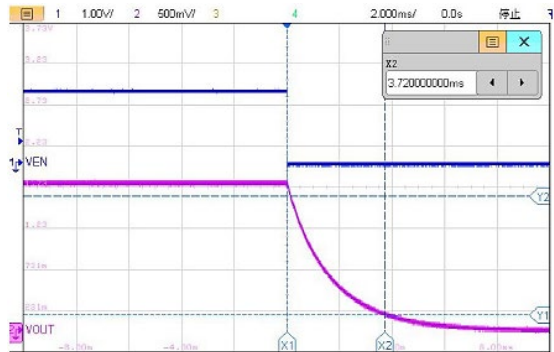

Turn Off VS. EN Voltage ( $V_{OUT} = 1.8\text{ V}$ ,  $I_{OUT} = 0\text{ mA}$ )

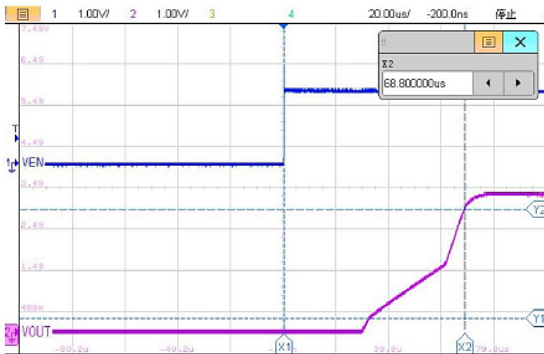

Turn On VS. EN Voltage ( $V_{OUT} = 3.3\text{ V}$ ,  $I_{OUT} = 0\text{ mA}$ )

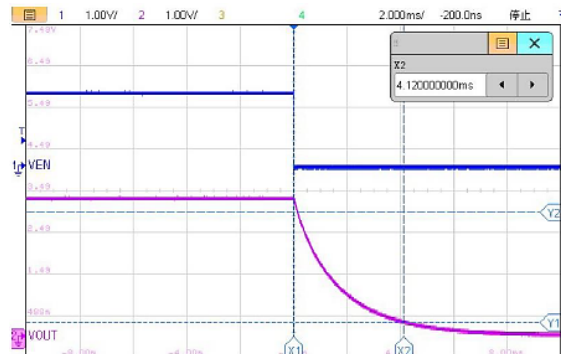

Turn Off VS. EN Voltage ( $V_{OUT} = 3.3\text{ V}$ ,  $I_{OUT} = 0\text{ mA}$ )

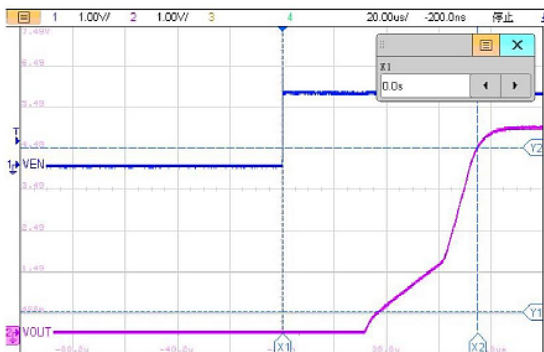

Turn On VS. EN Voltage ( $V_{OUT} = 5.0\text{ V}$ ,  $I_{OUT} = 0\text{ mA}$ )

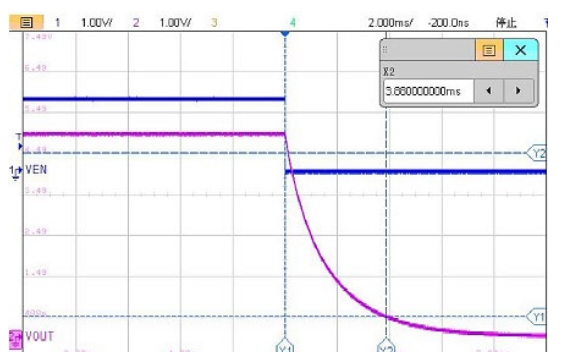

Turn Off VS. EN Voltage ( $V_{OUT} = 5.0\text{ V}$ ,  $I_{OUT} = 0\text{ mA}$ )

## Typical Performance Characteristics

Note: Typical Characteristics are intended to be used as reference data; they are not guaranteed.

### Input Transient Response

( $V_{IN} = V_{OUT} + 1\text{ V}$ ,  $I_{OUT} = 10\text{ mA}$ ,  $C_{OUT} = 10\text{ }\mu\text{F}$ ,  $t = 10\text{ }\mu\text{s}$ ,  $V_{IN}$  jump from 6 V to 18 V)

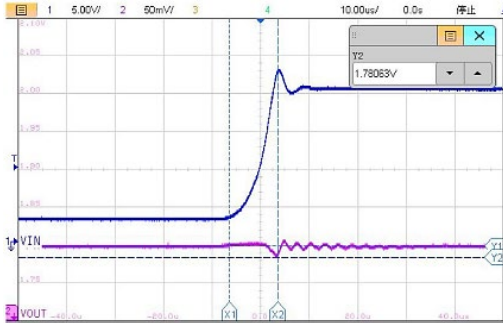

Input Transient Response ( $V_{OUT} = 1.8\text{ V}$ ,  $I_{OUT} = 1\text{ mA}$ )

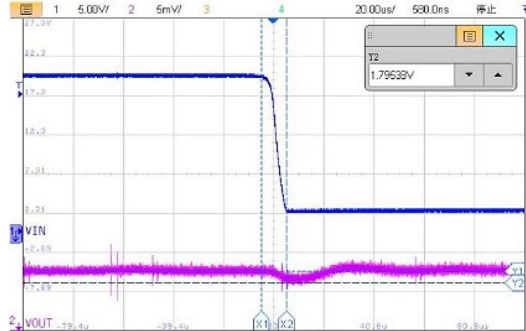

Input Transient Response ( $V_{OUT} = 1.8\text{ V}$ ,  $I_{OUT} = 1\text{ mA}$ )

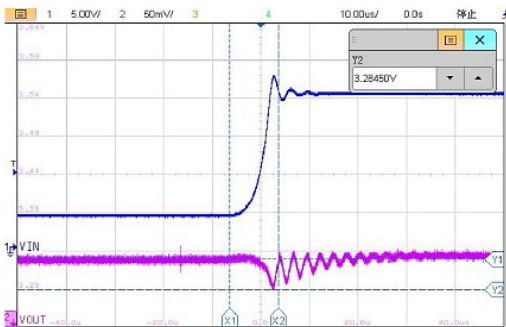

Input Transient Response ( $V_{OUT} = 3.3\text{ V}$ ,  $I_{OUT} = 1\text{ mA}$ )

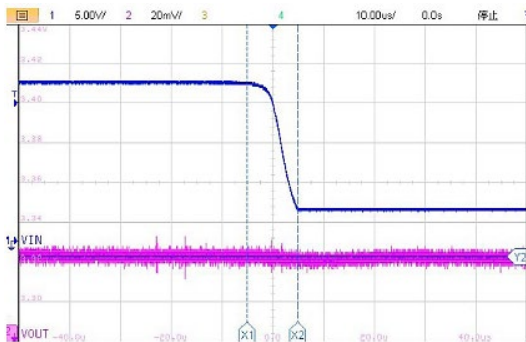

Input Transient Response ( $V_{OUT} = 3.3\text{ V}$ ,  $I_{OUT} = 1\text{ mA}$ )

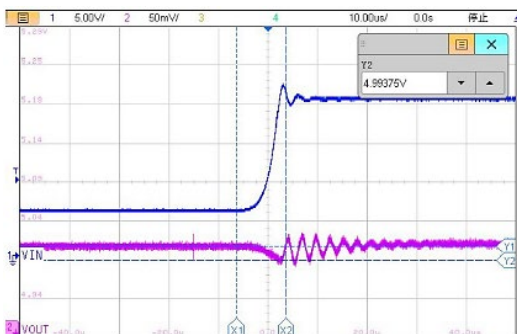

Input Transient Response ( $V_{OUT} = 5.0\text{ V}$ ,  $I_{OUT} = 1\text{ mA}$ )

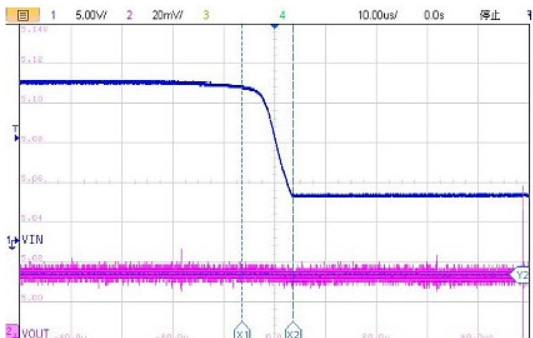

Input Transient Response ( $V_{OUT} = 5.0\text{ V}$ ,  $I_{OUT} = 1\text{ mA}$ )

## Typical Performance Characteristics

Note: Typical Characteristics are intended to be used as reference data; they are not guaranteed.

### Load Transient Response

( $V_{IN} = V_{OUT} + 1\text{ V}$ ,  $t = 10\ \mu\text{s}$ ,  $I_{OUT}$  jump from 1 mA to 1000 mA)

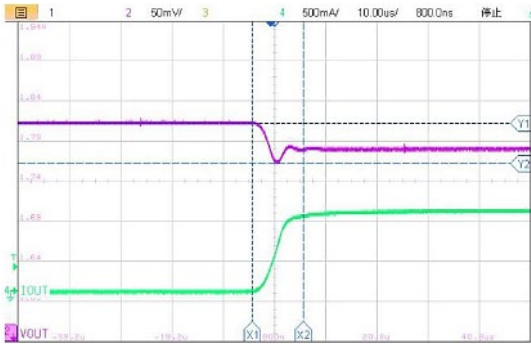

Load Transient Response ( $V_{OUT} = 1.8\text{ V}$ ,  $I_{OUT} = 1\sim 1000\text{ mA}$ )

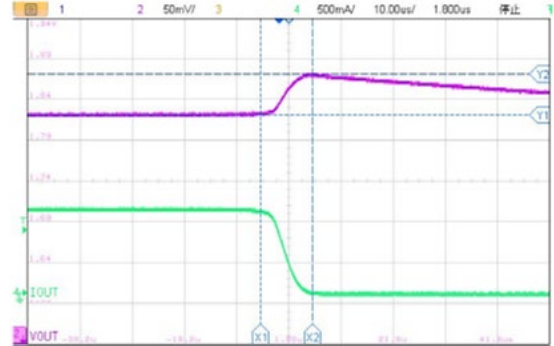

Load Transient Response ( $V_{OUT} = 1.8\text{ V}$ ,  $I_{OUT} = 1\sim 1000\text{ mA}$ )

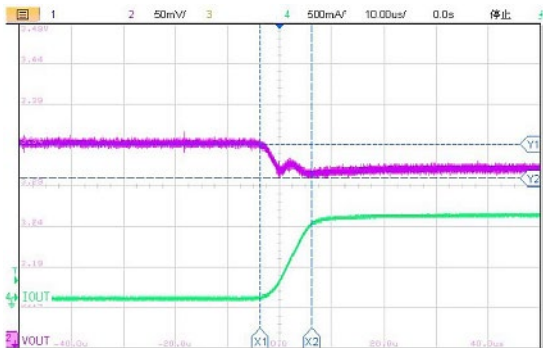

Load Transient Response ( $V_{OUT} = 3.3\text{ V}$ ,  $I_{OUT} = 1\sim 1000\text{ mA}$ )

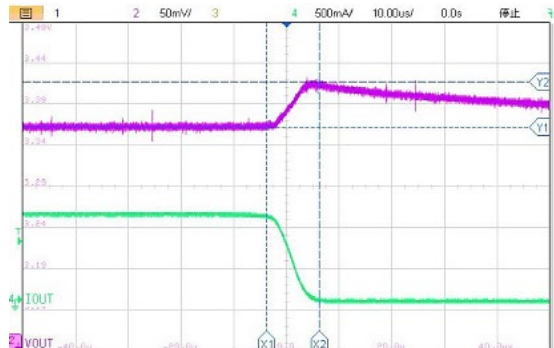

Load Transient Response ( $V_{OUT} = 3.3\text{ V}$ ,  $I_{OUT} = 1\sim 1000\text{ mA}$ )

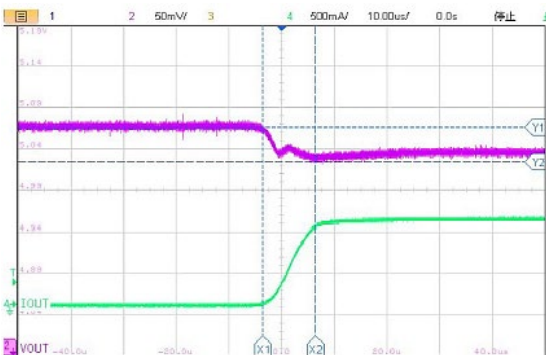

Load Transient Response ( $V_{OUT} = 5.0\text{ V}$ ,  $I_{OUT} = 1\sim 1000\text{ mA}$ )

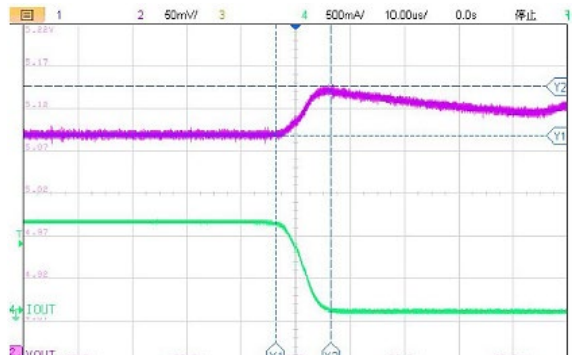

Load Transient Response ( $V_{OUT} = 5.0\text{ V}$ ,  $I_{OUT} = 1\sim 1000\text{ mA}$ )



## Typical Performance Characteristics

Note: Typical Characteristics are intended to be used as reference data; they are not guaranteed.

### Temperature Characteristics

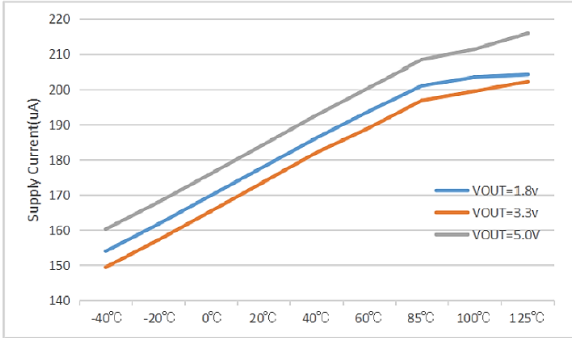

Supply Current VS. Temperature

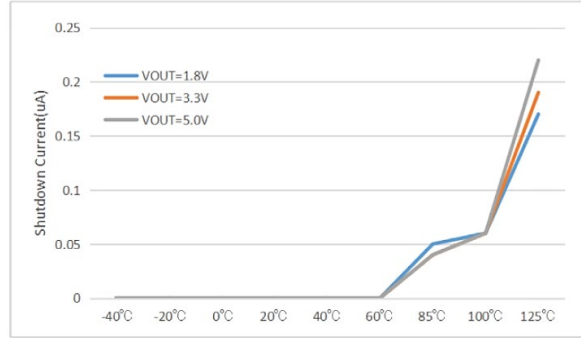

Shutdown Current VS. Temperature

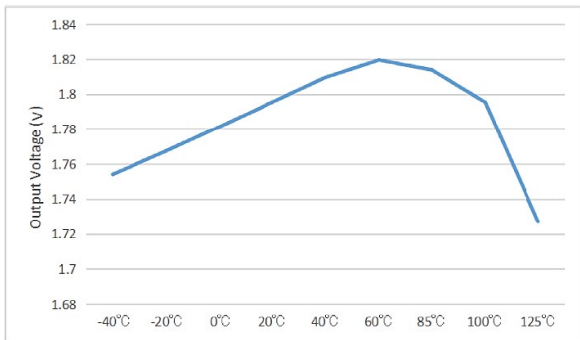

Output Voltage VS. Temperature (V<sub>OUT</sub> = 1.8V)

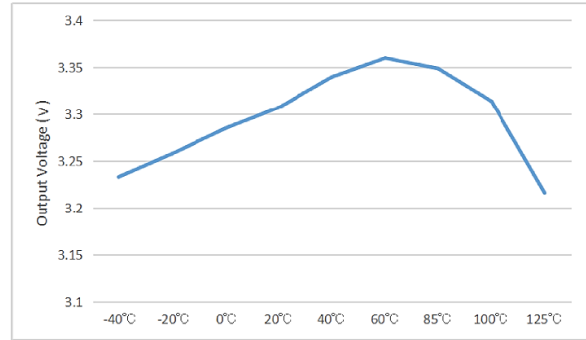

Output Voltage VS. Temperature (V<sub>OUT</sub> = 3.3V)

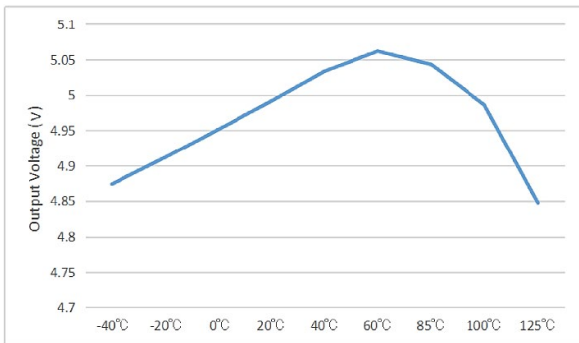

Output Voltage VS. Temperature (V<sub>OUT</sub> = 5.0V)

## Typical Performance Characteristics

Note: Typical Characteristics are intended to be used as reference data; they are not guaranteed.

### PSRR

( $V_{IN} = V_{OUT} + 1\text{ V}$ ,  $I_{OUT} = 0\text{ mA}$ ,  $C_{OUT} = 10\text{ }\mu\text{F}$ )

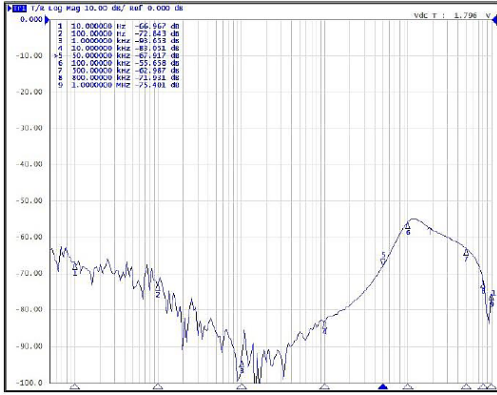

PSRR VS.  $I_{OUT}$  ( $V_{OUT} = 1.8\text{ V}$ ,  $I_{OUT} = 50\text{ mA}$ )

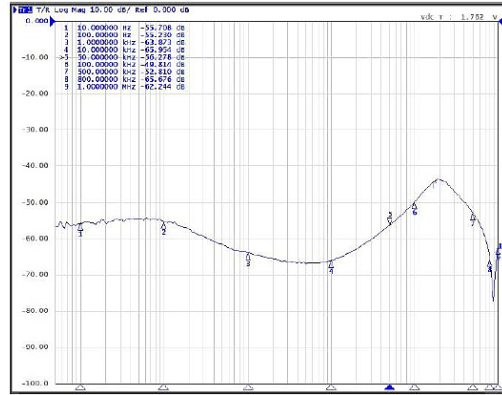

PSRR VS.  $I_{OUT}$  ( $V_{OUT} = 1.8\text{ V}$ ,  $I_{OUT} = 500\text{ mA}$ )

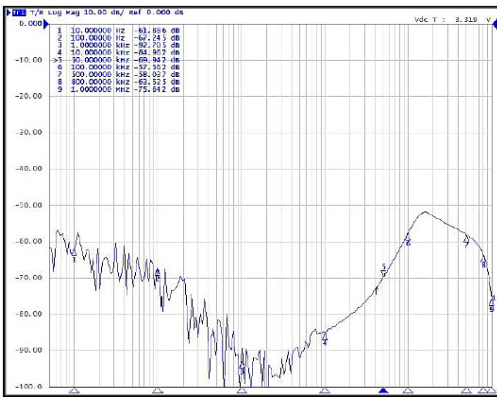

PSRR VS.  $I_{OUT}$  ( $V_{OUT} = 3.3\text{ V}$ ,  $I_{OUT} = 50\text{ mA}$ )

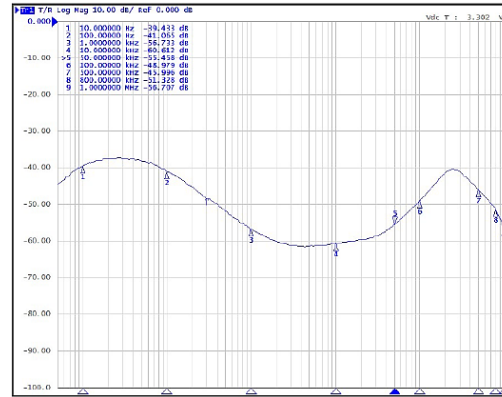

PSRR VS.  $I_{OUT}$  ( $V_{OUT} = 3.3\text{ V}$ ,  $I_{OUT} = 500\text{ mA}$ )

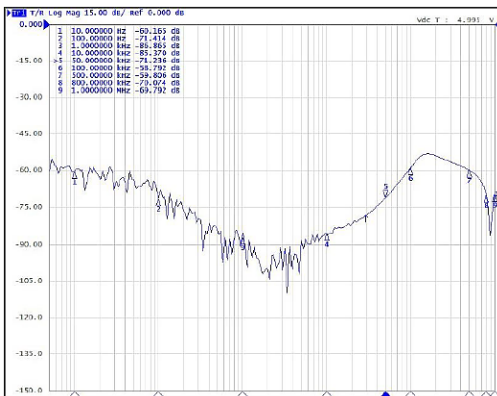

PSRR VS.  $I_{OUT}$  ( $V_{OUT} = 5.0\text{ V}$ ,  $I_{OUT} = 50\text{ mA}$ )

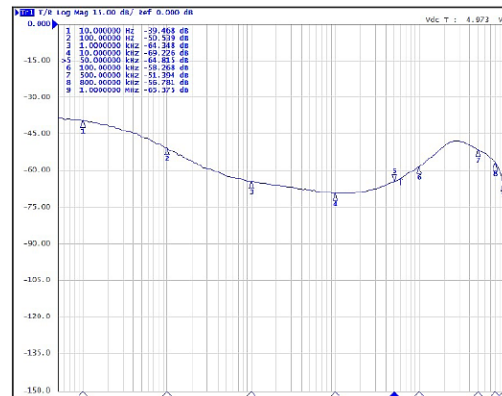

PSRR VS.  $I_{OUT}$  ( $V_{OUT} = 5.0\text{ V}$ ,  $I_{OUT} = 500\text{ mA}$ )

CAUTION: These devices are sensitive to electrostatic discharge; follow proper IC Handling Procedures.  
 Linearin and designs are registered trademarks of Linearin Technology Corporation.  
 ©Copyright Linearin Technology Corporation. All Rights Reserved.  
 All other trademarks mentioned are the property of their respective owners.

## Application Circuits

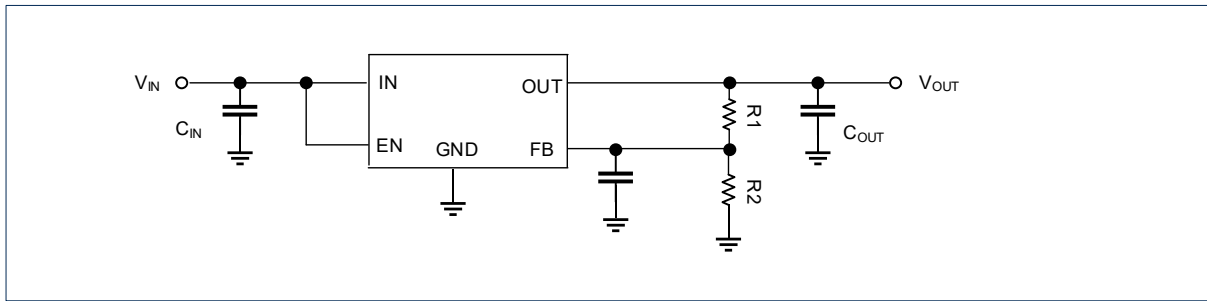

## Functional Description

### Input and Output Capacitor Selection

The LTP829 requires an output capacitance of 1 $\mu$ F or larger for stability. Use X5R-type and X7R-type ceramic capacitors because these capacitors have minimal variation in value and equivalent series resistance (ESR) over temperature. When choosing a capacitor for a specific application, pay attention to the DC bias characteristics for the capacitor. Higher output voltages cause a significant derating of the capacitor. Although an input capacitor is not required for stability, good analog design practice is to connect a capacitor from IN to GND. Some input supplies have a high impedance, thus placing the input capacitor on the input supply helps reduce the input impedance. This capacitor counteracts reactive input sources and improves transient response, input ripple, and PSRR. If the input supply has a high impedance over a large range of frequencies, several input capacitors can be used in parallel to lower the impedance over frequency. Use a higher-value capacitor if large, fast, rise-time load transients are anticipated, or if the device is located several inches from the input power source.

### Application of Electrolytic Capacitor

If the electrolytic capacitor should be used as input and output capacitor, the capacitance of the capacitor must be greater.

### Enable

The LTP829 has an EN pin to turn on or turn off the regulator. When the EN pin is in logic high, the regulator will be turned on. The shutdown current is almost 0 $\mu$ A typical. The EN pin may be directly tied to VIN to keep the part on. The Enable input is CMOS logic and cannot be left floating.

### Setting the Output Voltage

The LTP829 develops a 0.64 V reference voltage, VFB, between the output and the adjust terminal. This voltage is applied across resistor R1 to generate a constant current. The current IADJ from the ADJ terminal could introduce DC offset to the output. Because, this offset is very small (about 0.1  $\mu$ A), it can be ignored. The constant current then flows through the output set resistor R2 and sets the output voltage to the desired level. Equation 2 is used for calculating VOUT:

$$V_{OUT} = V_{FB} \times (1 + R_1/R_2) \quad (2)$$

Although IADJ is very small, R1 + R2 should be limited to less than 100k $\Omega$  for optimum performance.

### Dropout Voltage

The LTP829 uses a PMOS pass transistor to achieve low dropout. When (VIN - VOUT) is less than the dropout voltage (VDO), the PMOS pass device is in the linear region of operation and the input-to-output resistance is the RDS(ON) of the PMOS pass element. VDO scales approximately with output current because the PMOS device behaves like a resistor in dropout mode. As with any linear regulator, PSRR and transient response degrade as (VIN - VOUT) approaches dropout operation.

## Functional Description

### Thermal Shutdown

Thermal shutdown protection disables the output when the junction temperature rises to approximately 150°C. Disabling the device eliminates the power dissipated by the device, allowing the device to cool. When the junction temperature cools to approximately 125°C, the output circuitry is again enabled. Depending on power dissipation, thermal resistance, and ambient temperature, the thermal protection circuit may cycle on and off. This cycling limits regulator dissipation, protecting the LDO from damage as a result of overheating. Activating the thermal shutdown feature usually indicates excessive power dissipation as a result of the product of the  $(V_{IN} - V_{OUT})$  voltage and the load current. For reliable operation, limit junction temperature to 125°C maximum.

### Thermal Considerations

For continuous operation, do not exceed absolute maximum junction temperature. The maximum power dissipation depends on the thermal resistance of the IC package, PCB layout, rate of surrounding airflow, and difference between junction and ambient temperature. The maximum power dissipation can be calculated by the following formula :

$$P_{D(MAX)} = (T_{J(MAX)} - T_A) / \theta_{JA}$$

where  $T_{J(MAX)}$  is the maximum junction temperature,  $T_A$  is the ambient temperature, and  $\theta_{JA}$  is the junction to ambient thermal resistance. For recommended operating condition specifications the maximum junction temperature is 125°C and  $T_A$  is the ambient temperature. The junction to ambient thermal resistance,  $\theta_{JA}$ , is layout dependent. The maximum power dissipation depends on the operating ambient temperature for fixed  $T_{J(MAX)}$  and thermal resistance,  $\theta_{JA}$ .

Package Dimension

SOT-223

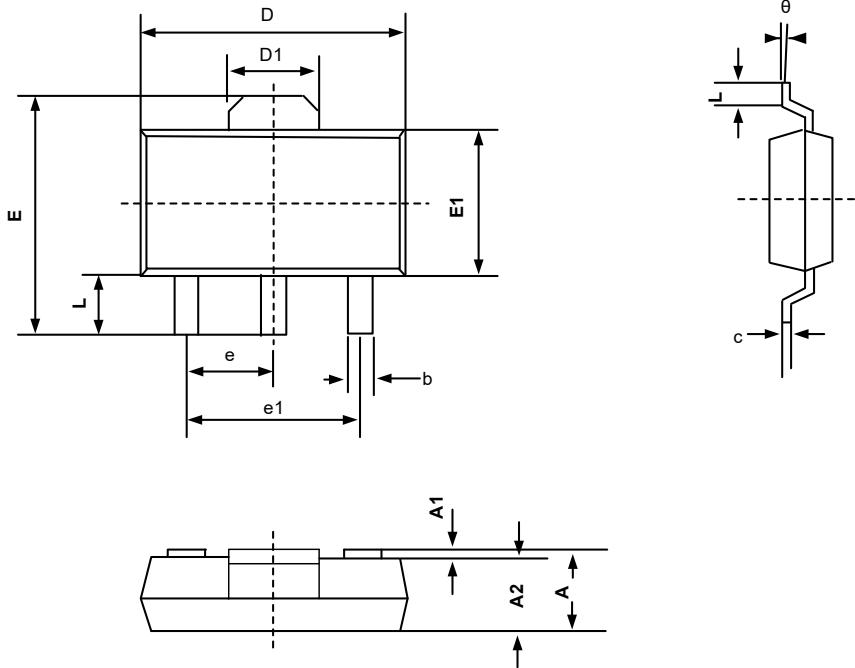

Unit: mm

Symbol	Dimensions In Millimeters	
	Min	Max
A	1.520	1.800
A1	0.000	0.100
A2	1.500	1.700
b	0.660	0.820
c	0.250	0.350
D	6.200	6.400
D1	2.900	3.100
E	6.830	7.070
E1	3.300	3.700
e	2.300BSC	
e1	4.500	4.700
L	0.900	1.150
θ	0°	10°

### Package Dimension

ESOP-8

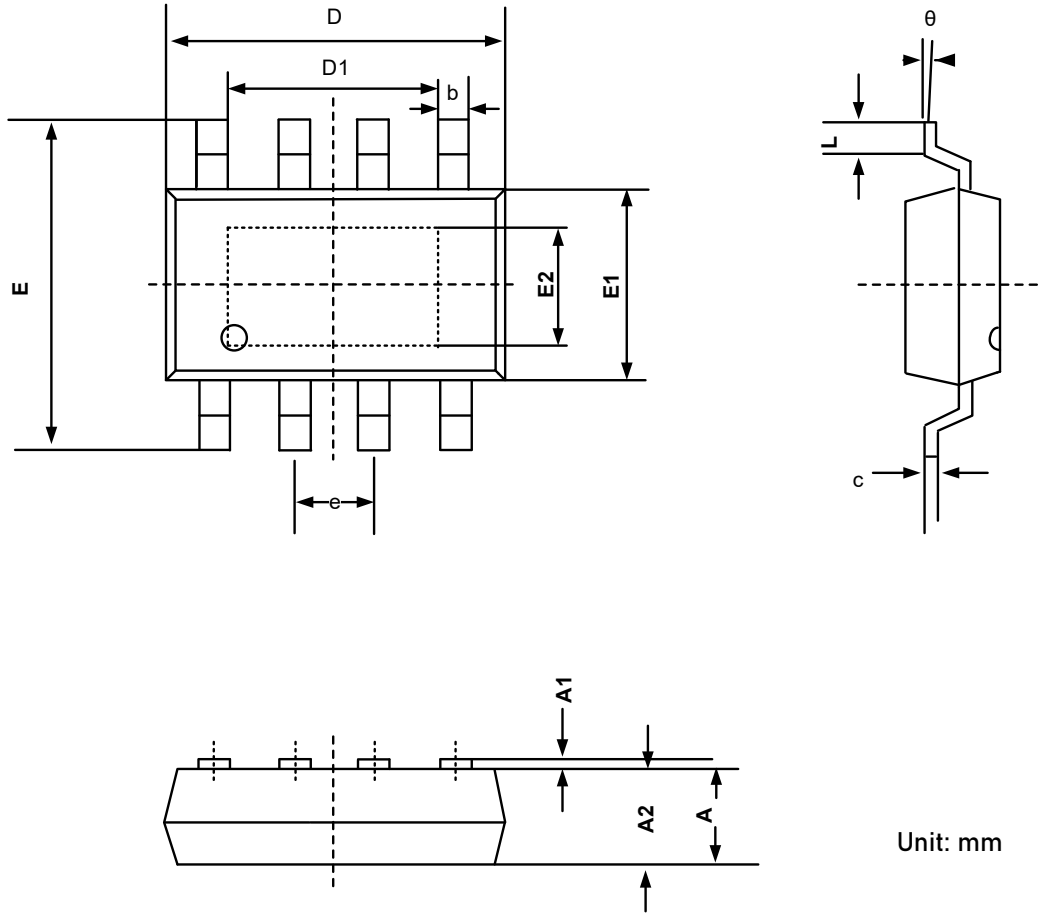

Unit: mm

Symbol	Dimensions In Millimeters	
	Min	Max
A		1.750
A1	0.100	0.225
A2	1.300	1.500
b	0.390	0.480
c	0.210	0.260
D	4.700	5.100
D1	3.200	3.400
E	5.800	6.200
E1	3.700	4.100
E2	2.300	2.500
e	1.270BSC	
L	0.500	0.800
θ	0°	8°

CAUTION: These devices are sensitive to electrostatic discharge; follow proper IC Handling Procedures.  
 Linearin and designs are registered trademarks of Linearin Technology Corporation.  
 ©Copyright Linearin Technology Corporation. All Rights Reserved.  
 All other trademarks mentioned are the property of their respective owners.

## Package Dimension

SOT-89

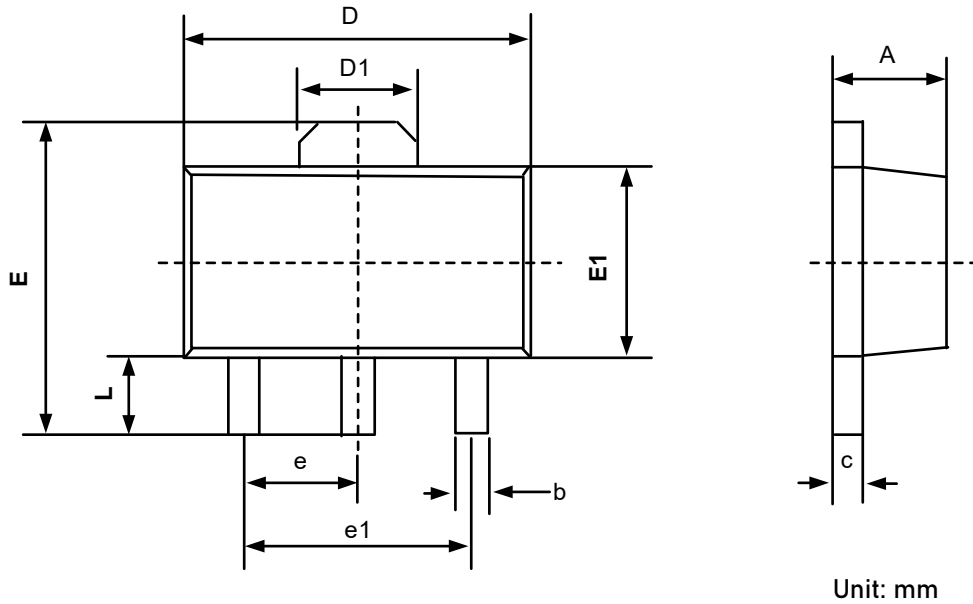

Symbol	Dimensions In Millimeters	
	Min	Max
A	1.400	1.600
b	0.320	0.520
c	0.350	0.440
D	4.400	4.600
D1	1.550REF	
E	3.940	4.250
E1	2.300	2.600
e	1.500BSC	
e1	3.000BSC	
L	0.900	1.200

## Package Dimension

DFN3×3-8

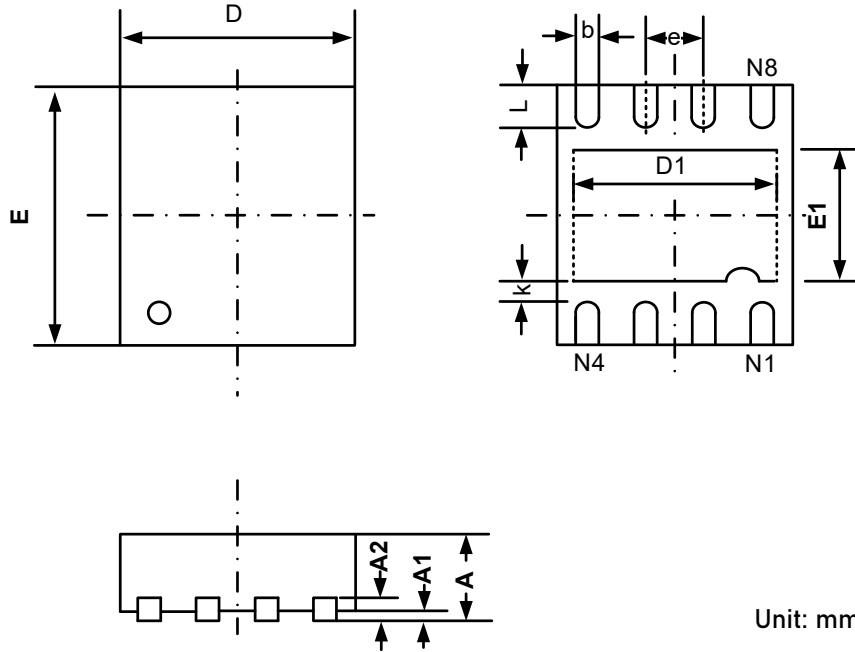

Unit: mm

Symbol	Dimensions In Millimeters	
	Min	Max
A	0.700	0.800
A1	0.000	0.050
A2	0.203REF	
b	0.180	0.300
D	2.900	3.100
D1	2.200	2.400
E	2.900	3.100
E1	1.400	1.600
e	0.650BSC	
L	0.375	0.575
k	0.200	



## Package Dimension

DFN2×2-6

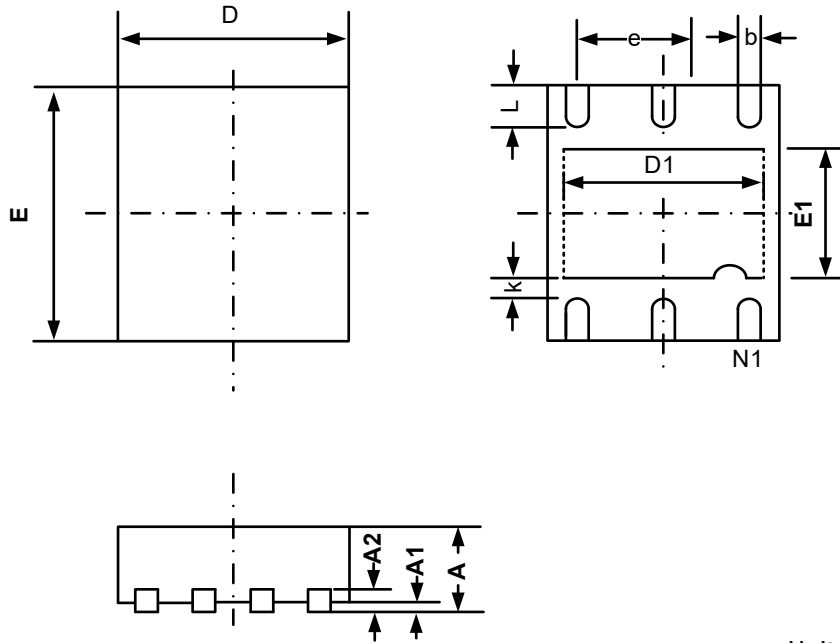

Unit: mm

Symbol	Dimensions In Millimeters	
	Min	Max
A	0.700	0.900
A1	0.000	0.050
A2	0.203REF	
b	0.180	0.300
D	1.900	2.100
D1	1.100	1.300
E	1.900	2.100
E1	0.600	0.800
e	0.650BSC	
L	0.250	0.450
k	0.200	