

1 2 3 4 5 6 7 8 9 10

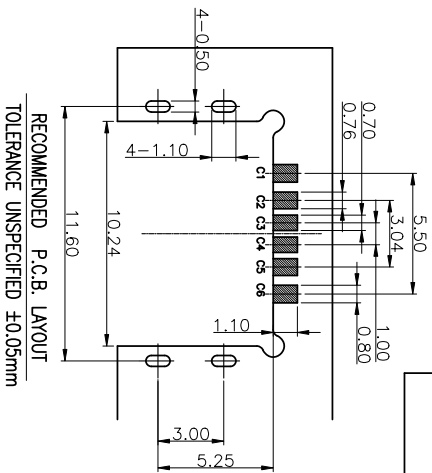
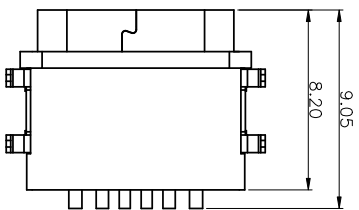

RECOMMENDED P.C.B. LAYOUT  
TOLERANCE UNSPECIFIED ±0.05mm

NOTES:  
SPECIFICATION:

- CURRENT RATING: 3.0A MAX
- VOLTAGE: 100 VAC
- TEMPERATURE RANGE: -30 °C ~ 85 °C
- CONTACT RESISTANCE: 40 MILLIONHM MAX
- INSULATION RESISTANCE: 100 MEGOHMS MIN.
- INSERTION FORCE : 5N~20N
- UNMATING FORCE: 8N~20N
- DURABILITY: 10,000 CYCLES
- WATER PROOFNESS:THISPRODUCTS BASED ON IPX7.

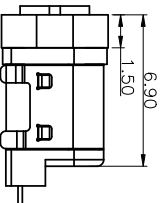
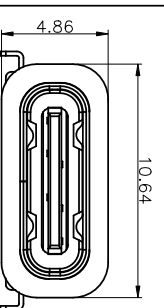
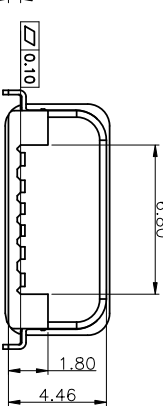
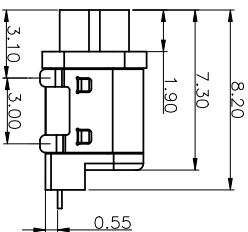
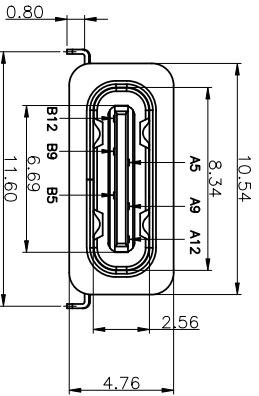

加防水圈示意图

备注:

NO.	料号	备注
1	AAOB010-078	不带硅胶
2	AAOB010-080	带硅胶

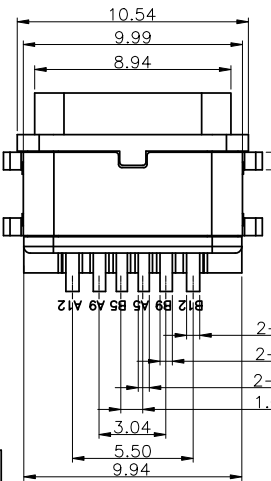

5	SHELL	STAINLESS STEEL	NI Plated	1PCS
4	SHIELDING PLATE	STAINLESS STEEL	NI Plated	1PCS
3	CONTACT	COPPER ALLOY	TIN/Au/NI Plated	1SET
2	SHELL HOUSING	HIGH TEMPERATURE PLASTIC	BLACK	1PCS
1	HOUSING	HIGH TEMPERATURE PLASTIC	BLACK	1PCS
NO. DESCRIPTION		MATERIAL		REMARKS
				QTY

PIN ASSIGNMENT:

PIN NO	A1&B12	A4&B9	A5	A5	A9&B4	A12&B1
SIGNAL NAME	GND	VBUS	CC1	CC2	VBUS	GND
PCB PAD NO.	C1	C2	C3	C4	C5	C6

产品图  
PRODUCT CHART DWG

公差一览表  
TOLERANCE UNLESS OTHERWISE SPECIFIED

X	±0.25	X	±5.°
X	±0.20	X	±2.°
.XX	±0.15	.XX	±1.°
.XXX	±0.10	.XXX	±0.5°

深圳市精拓金电子有限公司  
Shenzhen Jing Tu Jin Electronics Co., Ltd.

单位	MM	制图	林属升	制图料号	918-418K2025S40013
比例	1:1	审核	郭志富	产品名称	TYPE-C3 防水母座双包裹8 24脚插板
日期	2016-09-09	核准	黄国荣	PRODUCT NO	0.8LCP 覆胶单排5MT 6PIN
DATE		APPD		角法	
				版本	AO
				VER	

G

F

E

D

C

B

A

1 2 3 4 5 6 7 8 9 10