

# C3M0120090D

## Silicon Carbide Power MOSFET

### C3M™ MOSFET Technology

#### N-Channel Enhancement Mode

#### Features

- C3M SiC MOSFET technology
- High blocking voltage with low On-resistance
- High speed switching with low capacitances
- Fast intrinsic diode with low reverse recovery (Qrr)
- Halogen free, RoHS compliant

#### Benefits

- Higher system efficiency
- Reduced cooling requirements
- Increased power density
- Increased system switching frequency

#### Applications

- Renewable energy
- EV battery chargers
- High voltage DC/DC converters
- Switch Mode Power Supplies
- Lighting

$V_{DS}$	900 V
$I_D @ 25^\circ\text{C}$	23 A
$R_{DS(on)}$	120 mΩ

#### Package

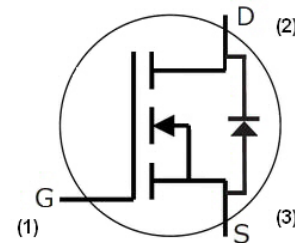
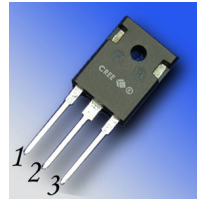

Part Number	Package	Marking
C3M0120090D	TO-247-3	C3M0120090

#### Maximum Ratings ( $T_C = 25^\circ\text{C}$ unless otherwise specified)

Symbol	Parameter	Value	Unit	Test Conditions	Note
$V_{DSmax}$	Drain - Source Voltage	900	V	$V_{GS} = 0\text{ V}, I_D = 100\ \mu\text{A}$	
$V_{GSmax}$	Gate - Source Voltage (dynamic)	-8/+19	V	AC ( $f > 1\text{ Hz}$ )	Note: 1
$V_{GSop}$	Gate - Source Voltage (static)	-4/+15	V	Static	Note: 2
$I_D$	Continuous Drain Current	23	A	$V_{GS} = 15\text{ V}, T_C = 25^\circ\text{C}$	Fig. 19
		15		$V_{GS} = 15\text{ V}, T_C = 100^\circ\text{C}$	
$I_{D(pulse)}$	Pulsed Drain Current	50	A	Pulse width $t_p$ limited by $T_{jmax}$	Fig. 22
$P_D$	Power Dissipation	97	W	$T_C = 25^\circ\text{C}, T_J = 150^\circ\text{C}$	Fig. 20
$T_J, T_{stg}$	Operating Junction and Storage Temperature	-55 to +150	$^\circ\text{C}$		
$T_L$	Solder Temperature	260	$^\circ\text{C}$	1.6mm (0.063") from case for 10s	
$M_d$	Mounting Torque	1 8.8	Nm lbf-in	M3 or 6-32 screw	

Note (1): When using MOSFET Body Diode  $V_{GSmax} = -4\text{V}/+19\text{V}$

Note (2): MOSFET can also safely operate at 0/+15 V

Symbol	Parameter	Min.	Typ.	Max.	Unit	Test Conditions	Note
$V_{(BR)DSS}$	Drain-Source Breakdown Voltage	900			V	$V_{GS} = 0\text{ V}, I_D = 100\ \mu\text{A}$	
$V_{GS(th)}$	Gate Threshold Voltage	1.8	2.1	3.5	V	$V_{DS} = V_{GS}, I_D = 3\ \text{mA}$	Fig. 11
			1.6		V	$V_{DS} = V_{GS}, I_D = 3\ \text{mA}, T_J = 150^\circ\text{C}$	
$I_{DSS}$	Zero Gate Voltage Drain Current		1	100	$\mu\text{A}$	$V_{DS} = 900\ \text{V}, V_{GS} = 0\ \text{V}$	
$I_{GSS}$	Gate-Source Leakage Current		10	250	nA	$V_{GS} = 15\ \text{V}, V_{DS} = 0\ \text{V}$	
$R_{DS(on)}$	Drain-Source On-State Resistance		120	155	m $\Omega$	$V_{GS} = 15\ \text{V}, I_D = 15\ \text{A}$	Fig. 4, 5, 6
			170			$V_{GS} = 15\ \text{V}, I_D = 15\ \text{A}, T_J = 150^\circ\text{C}$	
$g_{fs}$	Transconductance		8.9		S	$V_{DS} = 20\ \text{V}, I_{DS} = 15\ \text{A}$	Fig. 7
			7.1			$V_{DS} = 20\ \text{V}, I_{DS} = 15\ \text{A}, T_J = 150^\circ\text{C}$	
$C_{iss}$	Input Capacitance		414		pF	$V_{GS} = 0\ \text{V}, V_{DS} = 600\ \text{V}$ $f = 1\ \text{MHz}$ $V_{AC} = 25\ \text{mV}$	Fig. 17, 18
$C_{oss}$	Output Capacitance		48				
$C_{rss}$	Reverse Transfer Capacitance		3				
$E_{oss}$	$C_{oss}$ Stored Energy		10.6		$\mu\text{J}$		Fig. 16
$E_{ON}$	Turn-On Switching Energy (Body Diode FWD)		176		$\mu\text{J}$	$V_{DS} = 400\ \text{V}, V_{GS} = -4\ \text{V}/15\ \text{V}, I_D = 15\ \text{A},$ $R_{G(ext)} = 2.5\ \Omega, L = 99\ \mu\text{H}, T_J = 150^\circ\text{C}$	Fig. 26, 29
$E_{OFF}$	Turn Off Switching Energy (Body Diode FWD)		36				
$t_{d(on)}$	Turn-On Delay Time		6		ns	$V_{DD} = 400\ \text{V}, V_{GS} = -4\ \text{V}/15\ \text{V}$ $I_D = 15\ \text{A}, R_{G(ext)} = 2.5\ \Omega,$ Timing relative to $V_{DS}$ Inductive load	Fig. 27, 29
$t_r$	Rise Time		32				
$t_{d(off)}$	Turn-Off Delay Time		14				
$t_f$	Fall Time		7				
$R_{G(int)}$	Internal Gate Resistance		13		$\Omega$	$f = 1\ \text{MHz}, V_{AC} = 25\ \text{mV}$	
$Q_{gs}$	Gate to Source Charge		5		nC	$V_{DS} = 400\ \text{V}, V_{GS} = -4\ \text{V}/15\ \text{V}$ $I_D = 15\ \text{A}$ Per IEC60747-8-4 pg 21	Fig. 12
$Q_{gd}$	Gate to Drain Charge		8				
$Q_g$	Total Gate Charge		21				

**Reverse Diode Characteristics** ( $T_c = 25^\circ\text{C}$  unless otherwise specified)

Symbol	Parameter	Typ.	Max.	Unit	Test Conditions	Note
$V_{SD}$	Diode Forward Voltage	4.8		V	$V_{GS} = -4\ \text{V}, I_{SD} = 7.5\ \text{A}$	Fig. 8, 9, 10
		4.4		V	$V_{GS} = -4\ \text{V}, I_{SD} = 7.5\ \text{A}, T_J = 150^\circ\text{C}$	
$I_S$	Continuous Diode Forward Current		15	A	$V_{GS} = -4\ \text{V}$	Note 1
$I_{S,pulse}$	Diode pulse Current		50	A	$V_{GS} = -4\ \text{V}$ , pulse width $t_p$ limited by $T_{jmax}$	Note 1
$t_{rr}$	Reverse Recover time	28		ns	$V_{GS} = -4\ \text{V}, I_{SD} = 15\ \text{A}, V_R = 400\ \text{V}$ $\text{dif}/\text{dt} = 600\ \text{A}/\mu\text{s}, T_J = 150^\circ\text{C}$	Note 1
$Q_{rr}$	Reverse Recovery Charge	127		nC		
$I_{rrm}$	Peak Reverse Recovery Current	6		A		

**Thermal Characteristics**

Symbol	Parameter	Max.	Unit	Test Conditions	Note
$R_{\theta JC}$	Thermal Resistance from Junction to Case	1.3	$^\circ\text{C}/\text{W}$		Fig. 21
$R_{\theta JA}$	Thermal Resistance From Junction to Ambient	40			

Note (3): Turn-off and Turn-on switching energy and timing values measured using SiC MOSFET Body Diode

## Typical Performance

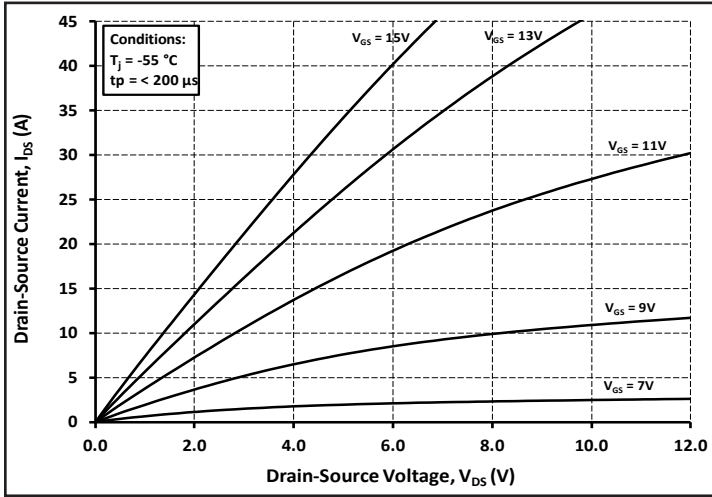

Figure 1. Output Characteristics  $T_J = -55\text{ }^\circ\text{C}$

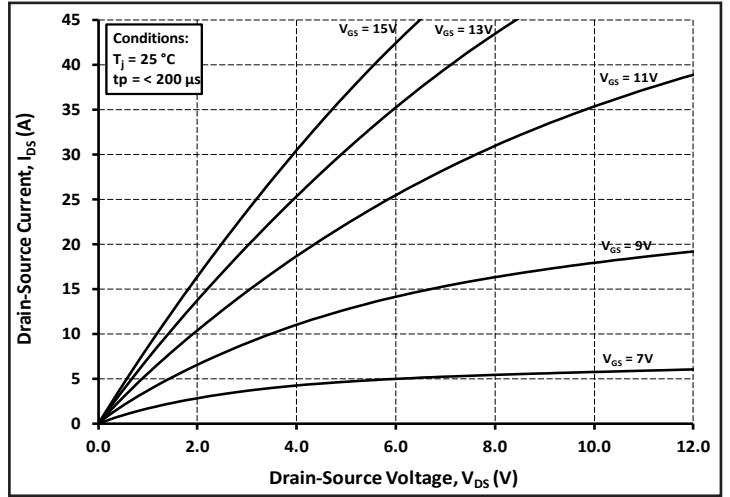

Figure 2. Output Characteristics  $T_J = 25\text{ }^\circ\text{C}$

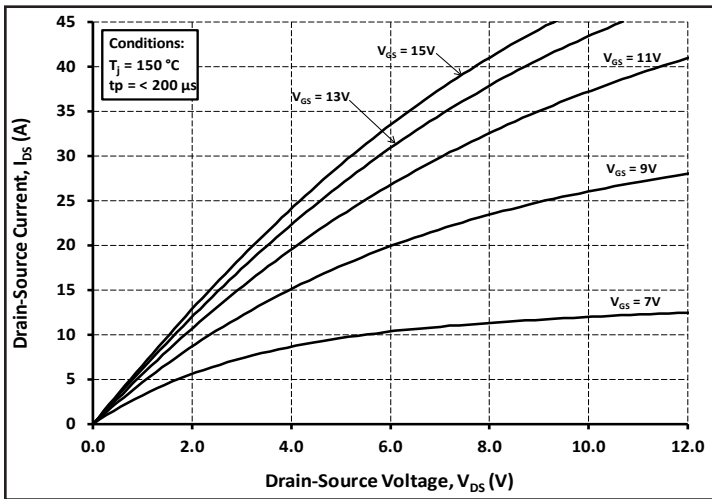

Figure 3. Output Characteristics  $T_J = 150\text{ }^\circ\text{C}$

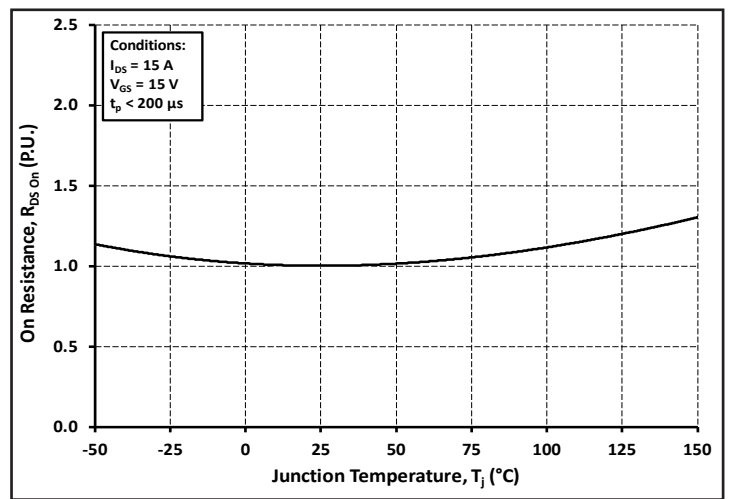

Figure 4. Normalized On-Resistance vs. Temperature

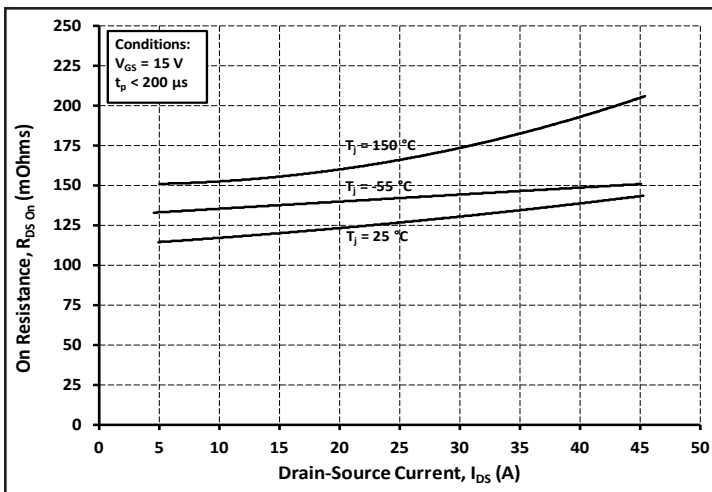

Figure 5. On-Resistance vs. Drain Current For Various Temperatures

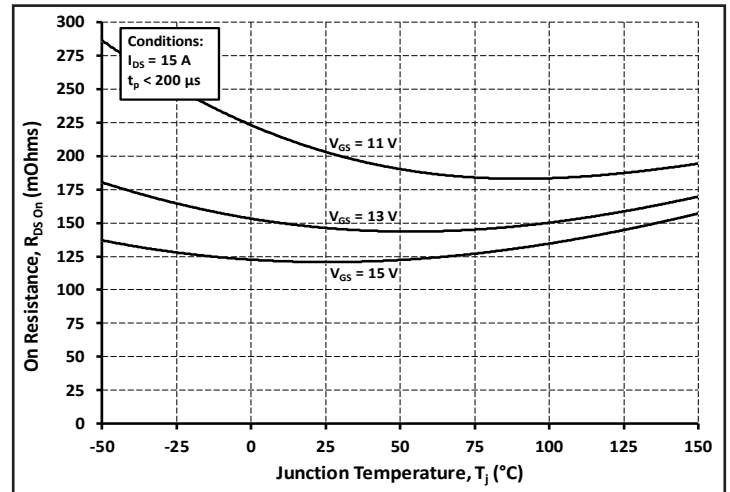

Figure 6. On-Resistance vs. Temperature For Various Gate Voltage

## Typical Performance

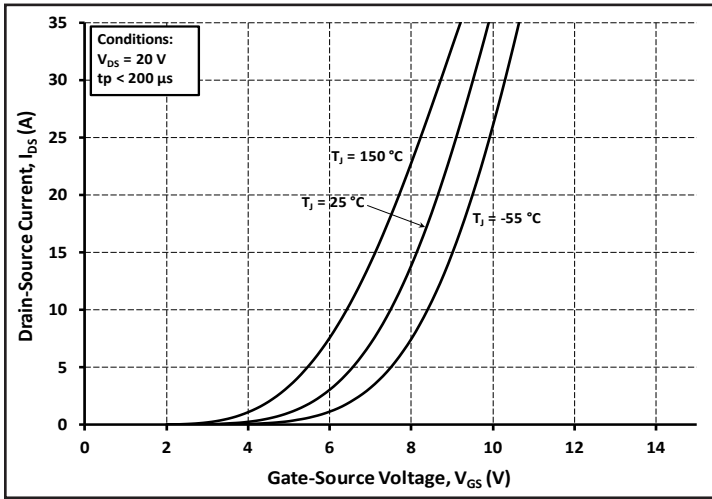

Figure 7. Transfer Characteristic for Various Junction Temperatures

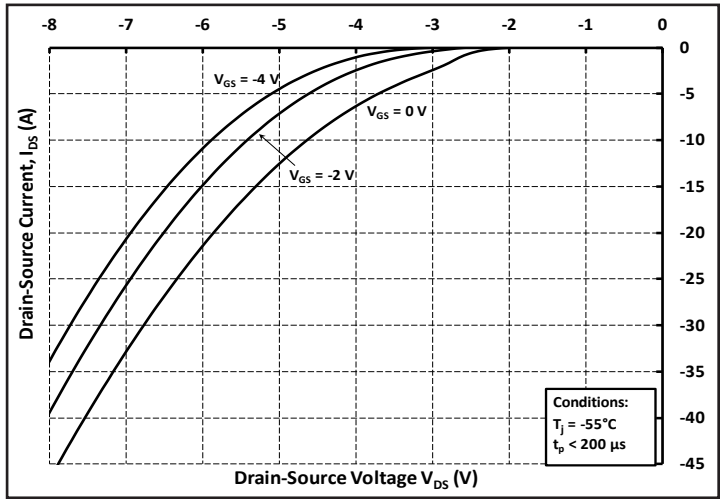

Figure 8. Body Diode Characteristic at  $-55\text{ }^\circ\text{C}$

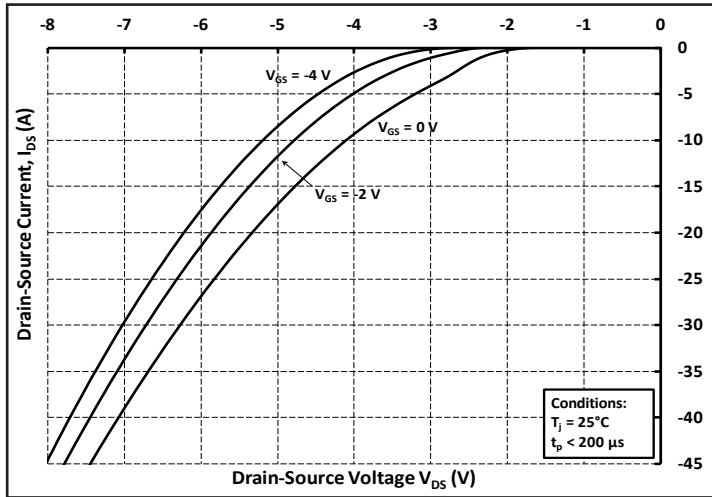

Figure 9. Body Diode Characteristic at  $25\text{ }^\circ\text{C}$

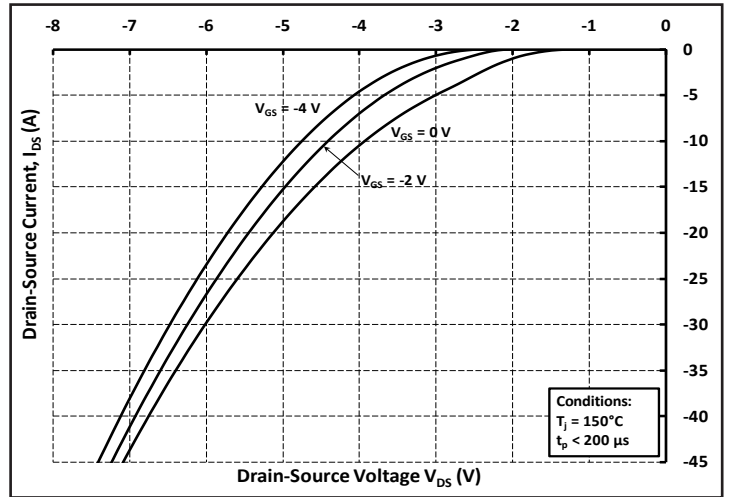

Figure 10. Body Diode Characteristic at  $150\text{ }^\circ\text{C}$

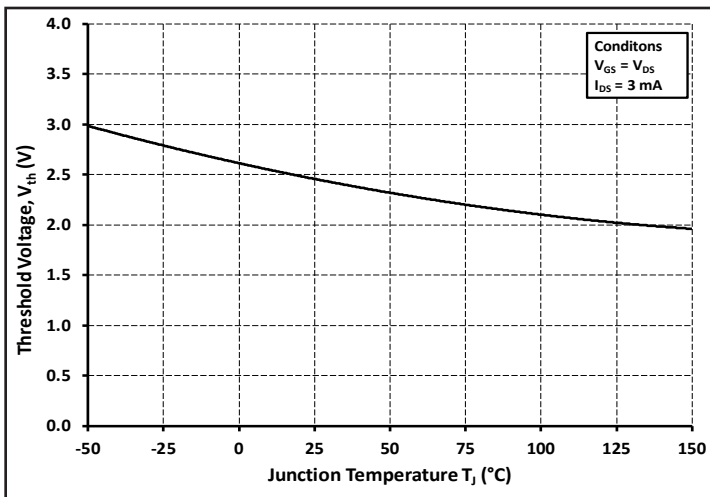

Figure 11. Threshold Voltage vs. Temperature

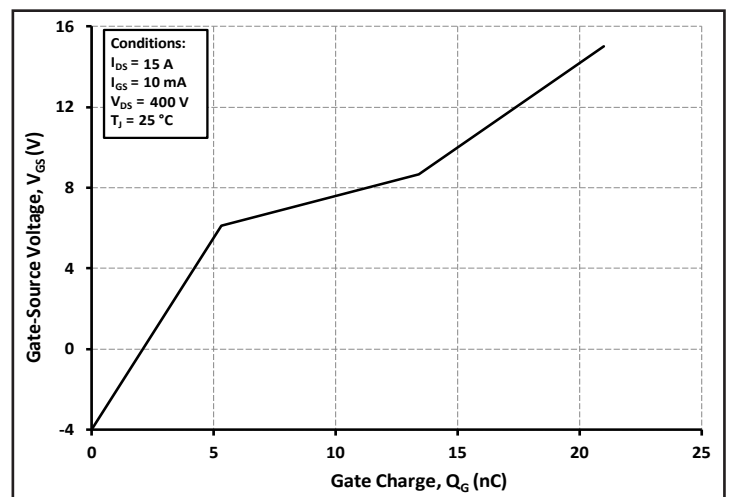

Figure 12. Gate Charge Characteristics

## Typical Performance

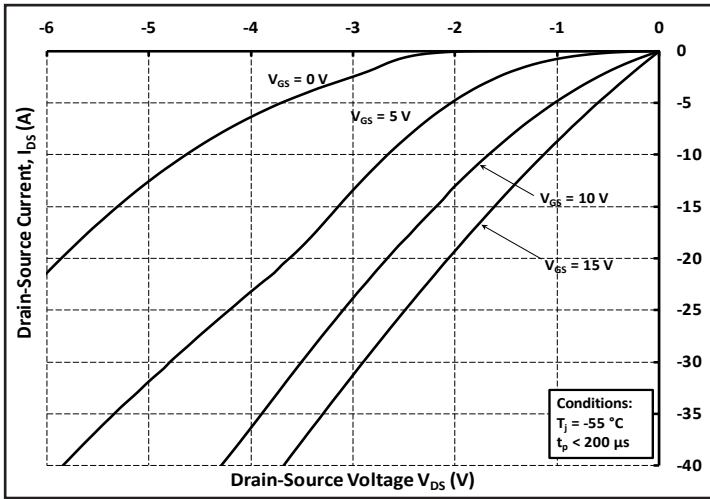

Figure 13. 3rd Quadrant Characteristic at  $-55\text{ }^\circ\text{C}$

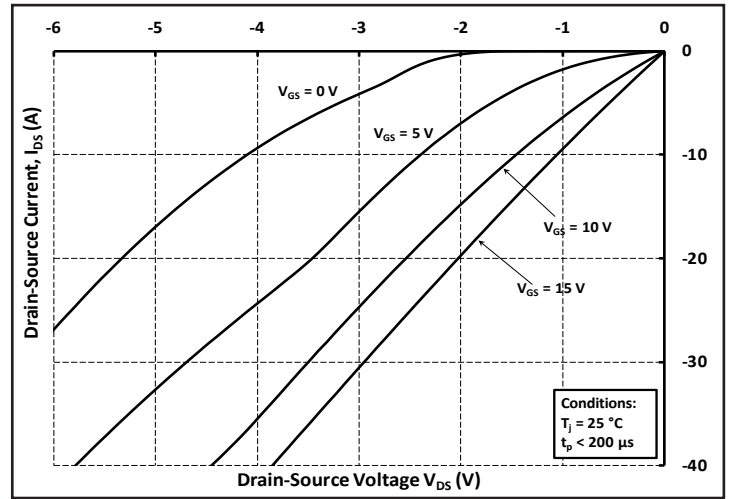

Figure 14. 3rd Quadrant Characteristic at  $25\text{ }^\circ\text{C}$

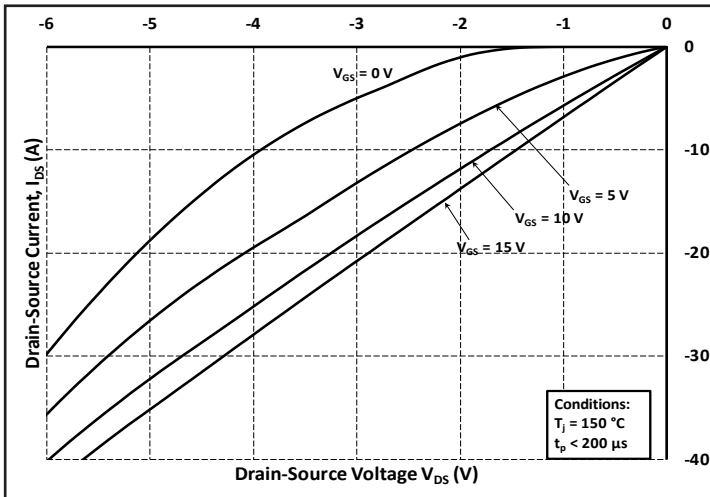

Figure 15. 3rd Quadrant Characteristic at  $150\text{ }^\circ\text{C}$

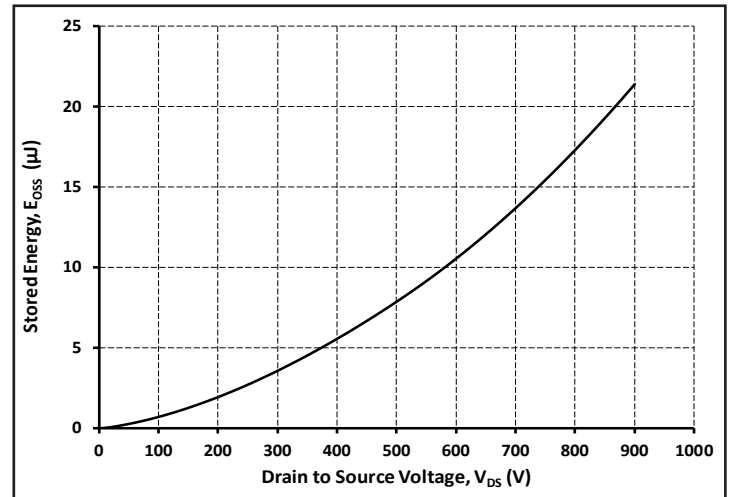

Figure 16. Output Capacitor Stored Energy

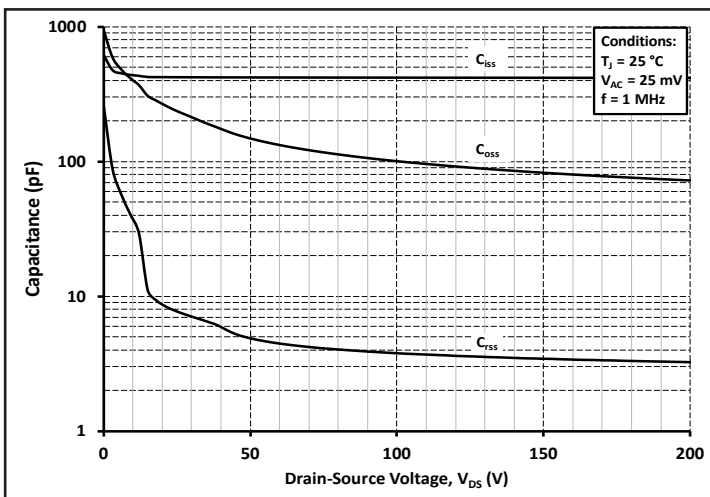

Figure 17. Capacitances vs. Drain-Source Voltage (0 - 200V)

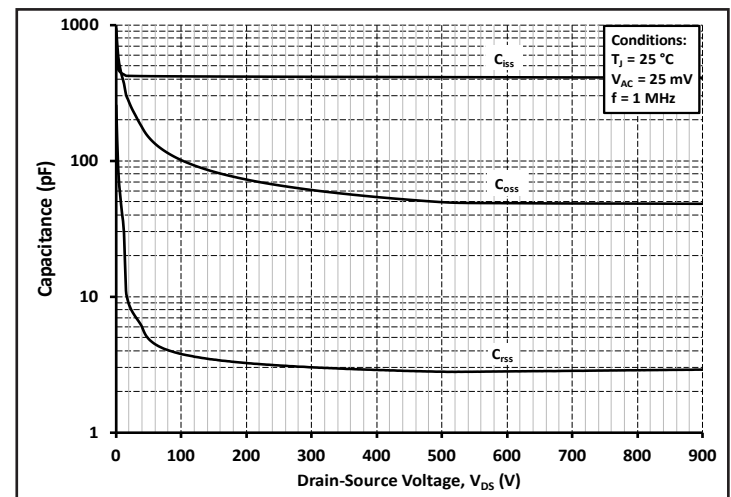

Figure 18. Capacitances vs. Drain-Source Voltage (0 - 900V)

## Typical Performance

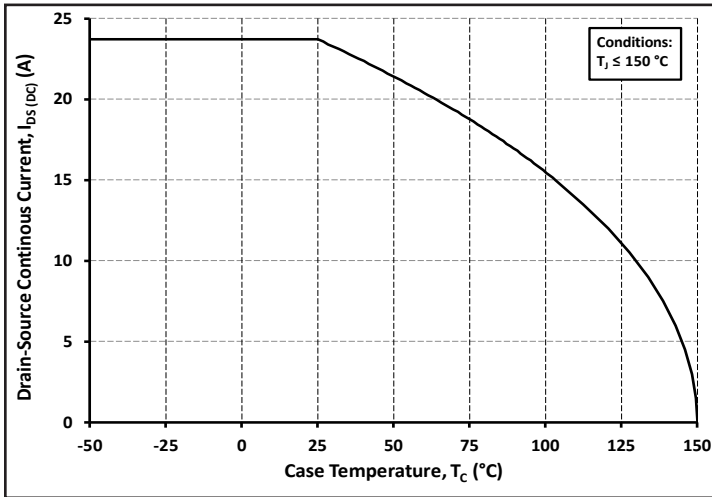

Figure 19. Continuous Drain Current Derating vs. Case Temperature

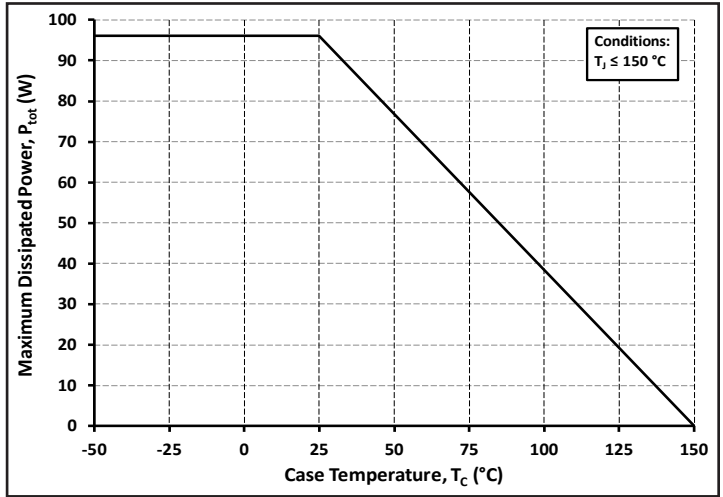

Figure 20. Maximum Power Dissipation Derating vs. Case Temperature

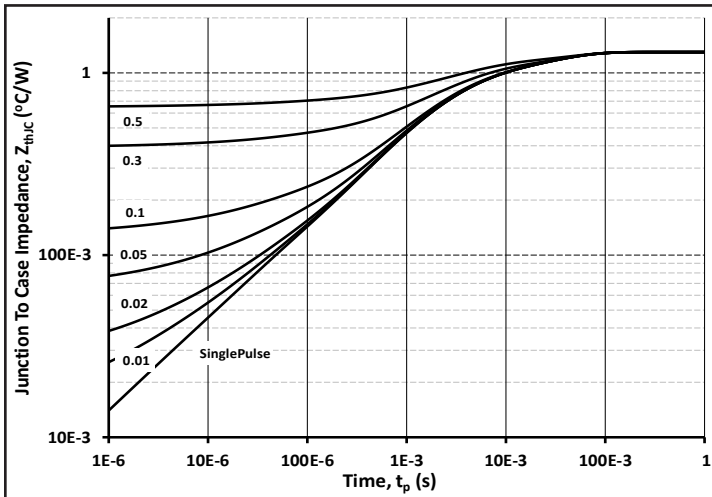

Figure 21. Transient Thermal Impedance (Junction - Case)

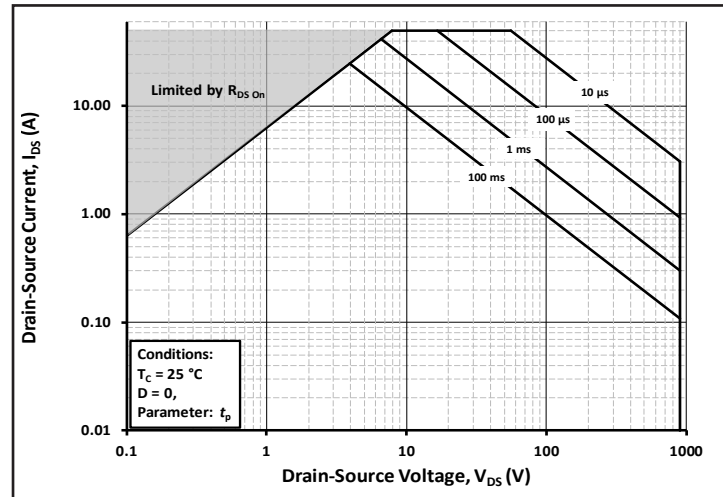

Figure 22. Safe Operating Area

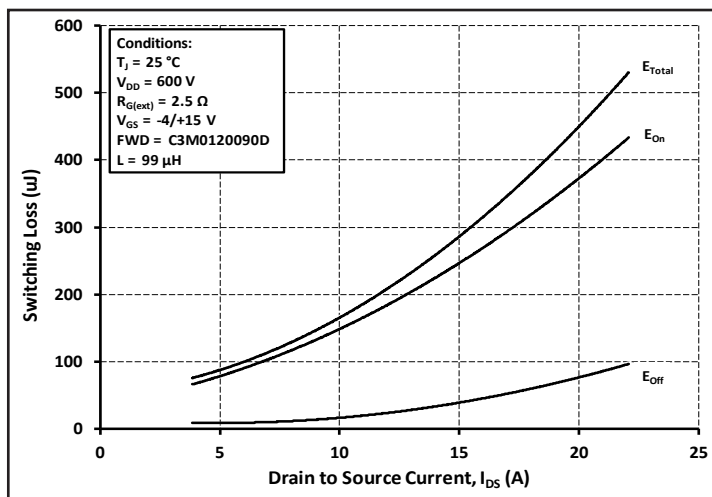

Figure 23. Clamped Inductive Switching Energy vs. Drain Current ( $V_{DD} = 600V$ )

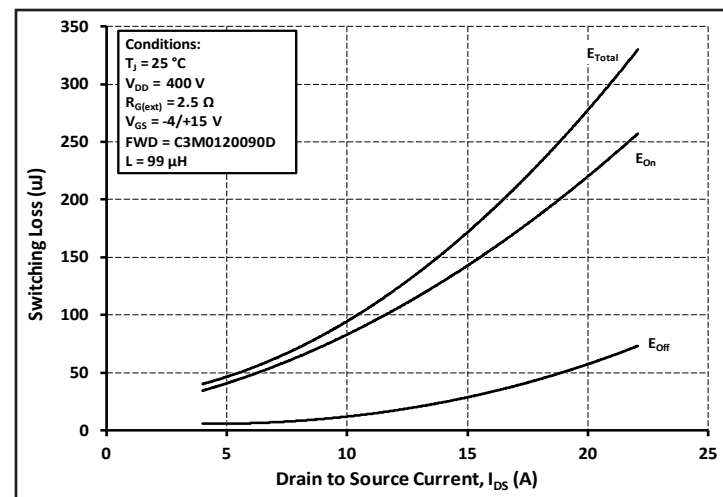

Figure 24. Clamped Inductive Switching Energy vs. Drain Current ( $V_{DD} = 400V$ )

## Typical Performance

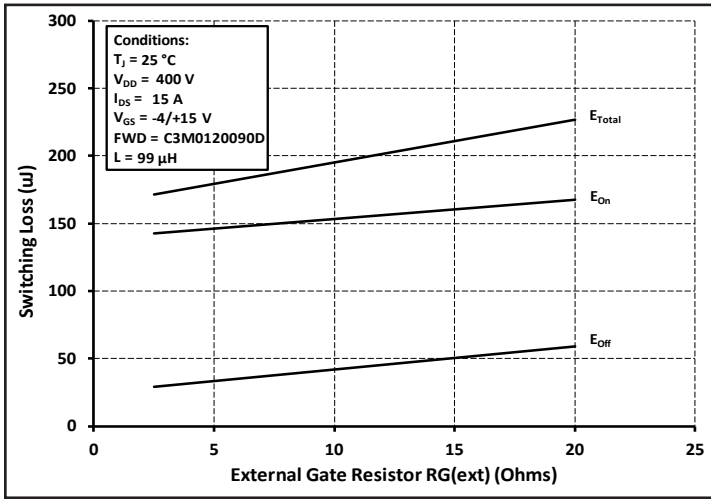

Figure 25. Clamped Inductive Switching Energy vs.  $R_{G(ext)}$

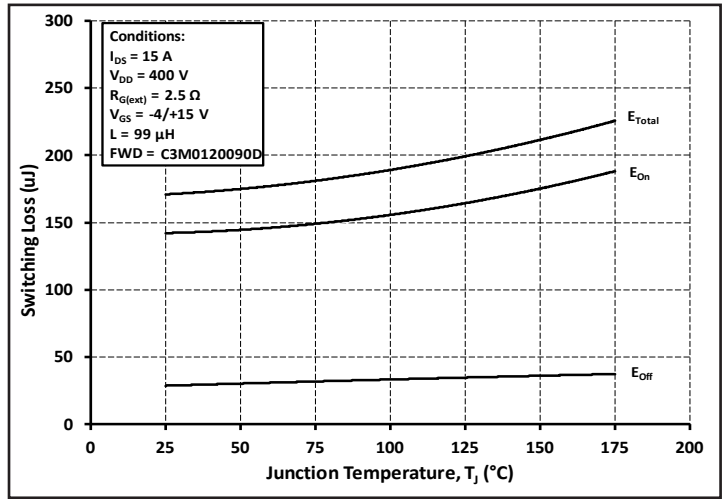

Figure 26. Clamped Inductive Switching Energy vs. Temperature

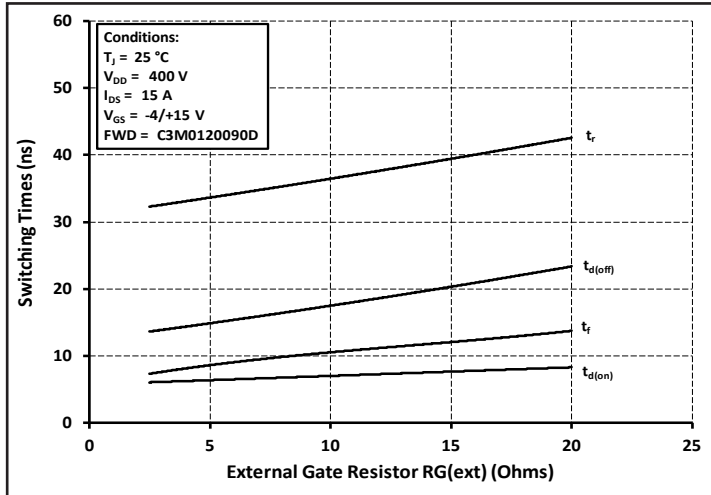

Figure 27. Switching Times vs.  $R_{G(ext)}$

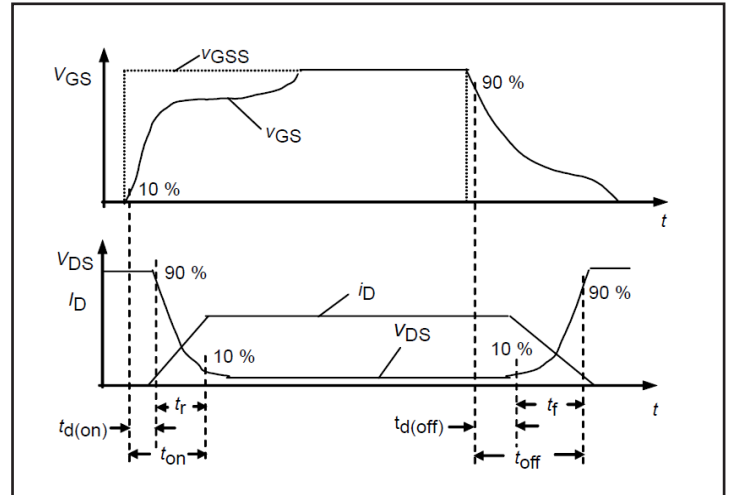

Figure 28. Switching Times Definition

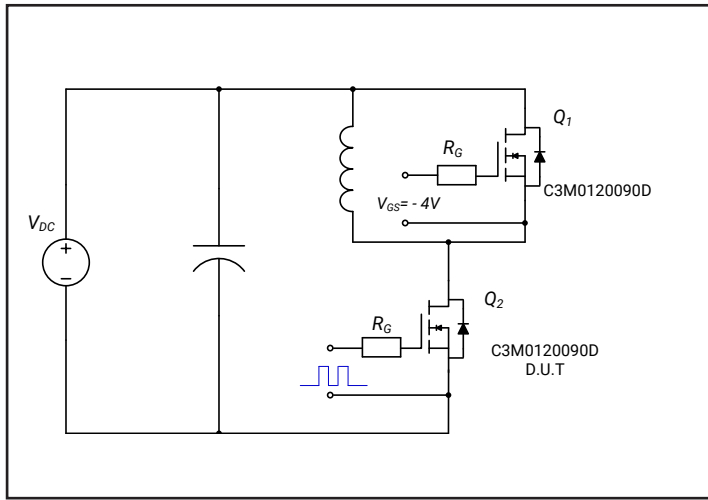

Figure 29. Clamped Inductive Switching Test Circuit

Note (3): Turn-off and Turn-on switching energy and timing values measured using SiC MOSFET Body Diode as shown above.



## Package Dimensions

Package TO-247-3

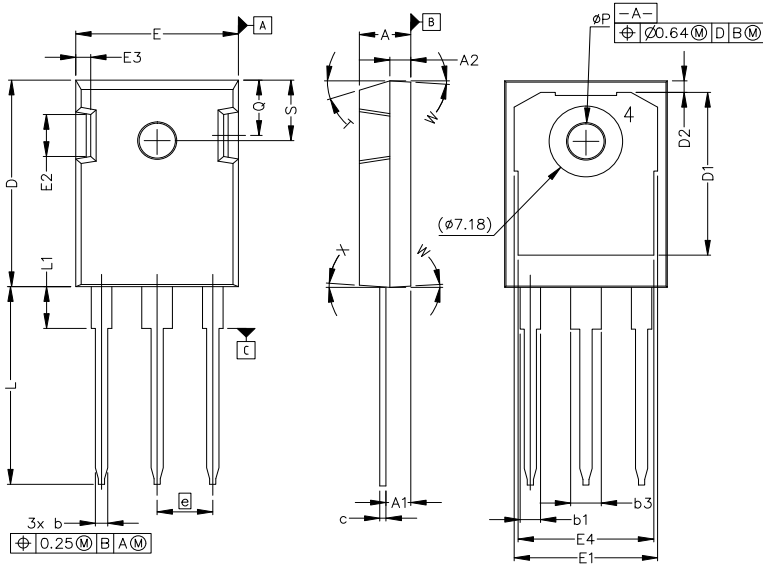

**Pinout Information:**

- Pin 1 = Gate
- Pin 2, 4 = Drain
- Pin 3 = Source

SYM	MILLIMETERS		INCHES	
	MIN	MAX	MIN	MAX
A	4.83	5.21	.190	.205
A1	2.29	2.54	.090	.100
A2	1.91	2.16	.075	.085
b	1.07	1.33	.042	.052
b1	1.91	2.41	.075	.095
b3	2.87	3.38	.113	.133
c	0.55	0.68	.022	.027
D	20.80	21.10	.819	.831
D1	16.25	17.65	.640	.695
D2	0.95	1.25	.037	.049
E	15.75	16.13	.620	.635
E1	13.10	14.15	.516	.557
E2	3.68	5.10	.145	.201
E3	1.00	1.90	.039	.075
E4	12.38	13.43	.487	.529
e	5.44 BSC		.214 BSC	
N	3		3	
L	19.81	20.32	.780	.800
L1	4.10	4.40	.161	.173
φP	3.51	3.65	.138	.144
Q	5.49	6.00	.216	.236
S	6.04	6.30	.238	.248
T	17.5° REF.			
W	3.5° REF.			
X	4° REF.			

## Recommended Solder Pad Layout

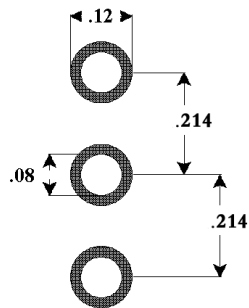

TO-247-3

## Notes

---

- **RoHS Compliance**  
The levels of RoHS restricted materials in this product are below the maximum concentration values (also referred to as the threshold limits) permitted for such substances, or are used in an exempted application, in accordance with EU Directive 2011/65/EC (RoHS2), as implemented January 2, 2013. RoHS Declarations for this product can be obtained from your Cree representative or from the Product Documentation sections of [www.cree.com](http://www.cree.com).
- **REACH Compliance**  
REACH substances of high concern (SVHCs) information is available for this product. Since the European Chemical Agency (ECHA) has published notice of their intent to frequently revise the SVHC listing for the foreseeable future, please contact a Cree representative to insure you get the most up-to-date REACH SVHC Declaration. REACH banned substance information (REACH Article 67) is also available upon request.
- This product has not been designed or tested for use in, and is not intended for use in, applications implanted into the human body nor in applications in which failure of the product could lead to death, personal injury or property damage, including but not limited to equipment used in the operation of nuclear facilities, life-support machines, cardiac defibrillators or similar emergency medical equipment, aircraft navigation or communication or control systems, air traffic control systems.

## Related Links

---

- **C2M PSPICE Models:** <http://wolfspeed.com/power/tools-and-support>
- **SiC MOSFET Isolated Gate Driver reference design:** <http://wolfspeed.com/power/tools-and-support>
- **SiC MOSFET Evaluation Board:** <http://wolfspeed.com/power/tools-and-support>