

Features

- Ideal for surface mounted application
- Low profile surface mounted application in order to optimize board space
- Built-in strain relief design
- Ultra fast recovery time for high efficient
- Glass passivated chip junction
- Lead-free parts meet RoHS requirements
- Compliant to Halogen-free

Mechanical data

- Epoxy:UL94-V0 rated flame retardant
- Case : Molded plastic, SMB/DO-214AA
- Terminals : Solder plated, solderable per MIL-STD-750, Method 2026
- Polarity : Indicated by cathode band
- Mounting Position : Any

Package outline

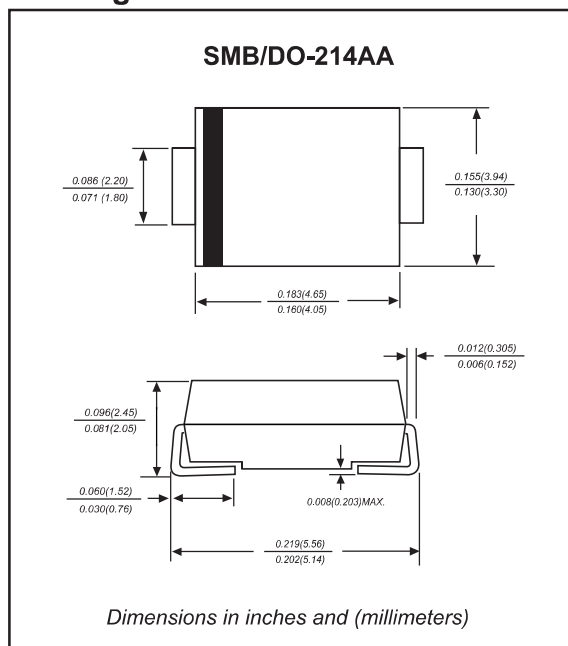

Maximum ratings (AT $T_A=25^{\circ}\text{C}$ unless otherwise noted)

PARAMETER	SYMBOLS	MURS160T3G	UNITS
Maximum repetitive peak reverse voltage	V_{RRM}	600	V
Maximum RMS voltage	V_{RMS}	420	V
Maximum continuous reverse voltage	V_R	600	V
Maximum average forward rectified current	I_o	1.0	A
Non-repetitive peak forward surge current 8.3ms single half sine-wave	I_{FSM}	35	A
Typical junction capacitance (Note 1)	C_J	15	pF
Operating junction temperature range	T_J	-55 to +175	$^{\circ}\text{C}$
Storage temperature range	T_{STG}	-65 to +175	$^{\circ}\text{C}$

Electrical characteristics (AT $T_A=25^{\circ}\text{C}$ unless otherwise noted)

PARAMETER	SYMBOLS	MURS160T3G	UNITS
Maximum instantaneous forward voltage at $I_F=1.0\text{A}$ $T_J=25^{\circ}\text{C}$	V_F	1.25	V
Maximum instantaneous forward voltage at $I_F=1.0\text{A}$ $T_J=150^{\circ}\text{C}$	V_F	1.05	V
Maximum reverse leakage current at rated V_R $T_J=25^{\circ}\text{C}$ $T_J=125^{\circ}\text{C}$	I_R	5.0 150	μA
Maximum reverse recovery time, (Note 2)	t_{rr}	50	ns

Thermal characteristics

PARAMETER	SYMBOLS	MURS160T3G	UNITS
Typical thermal resistance junction to ambient , (Note 3)	$R_{\theta JA}$	25	$^{\circ}\text{C} / \text{W}$
Typical thermal resistance junction to case , (Note 3)	$R_{\theta JC}$	15	$^{\circ}\text{C} / \text{W}$

Notes 1: Measured at 1 MHz and applied reverse voltage of 4.0 VDC

2: Measured with $I_F = 0.5\text{A}$, $I_R = 1\text{A}$, $t_{rr} = 0.25\text{A}$

3: Mounted on FR-4 PCB Copper, minimum recommended pad layout

Rating and characteristic curves

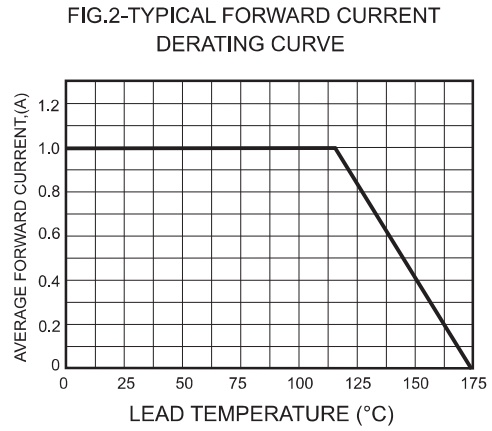
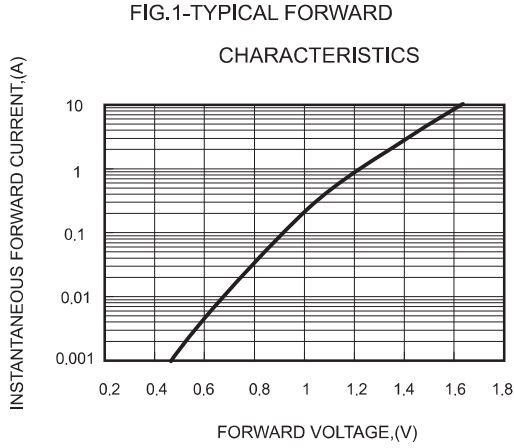
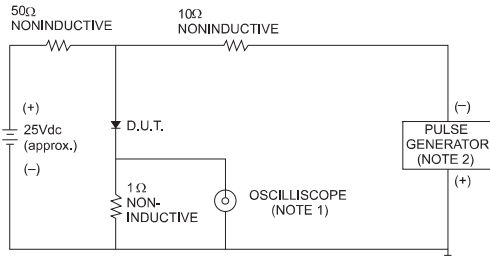

FIG.3- TEST CIRCUIT DIAGRAM AND REVERSE RECOVERY TIME CHARACTERISTICS



NOTES: 1. Rise Time= 7ns max., Input Impedance= 1 megohm, 22pF.
2. Rise Time= 10ns max., Source Impedance= 50 ohms.

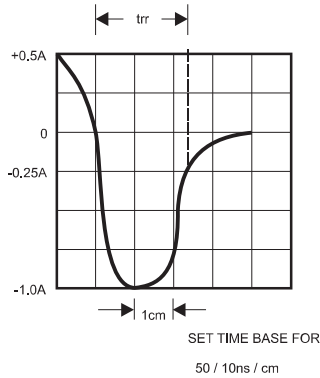

FIG.4-MAXIMUM NON-REPETITIVE FORWARD SURGE CURRENT

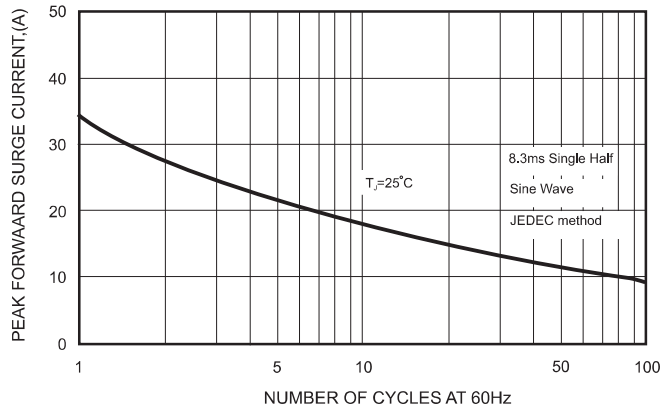
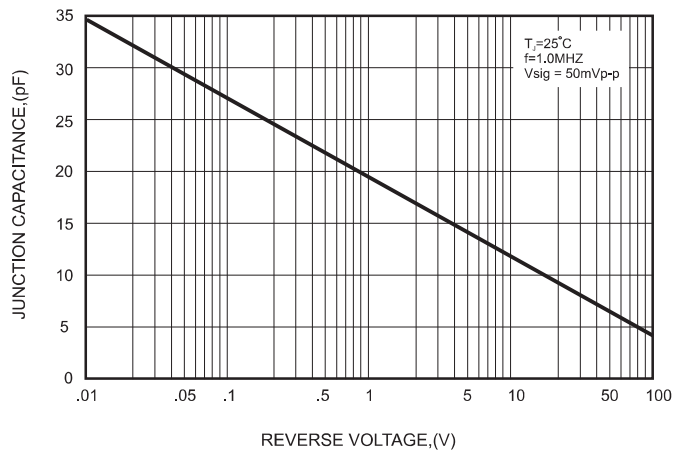



FIG.5-TYPICAL JUNCTION CAPACITANCE



Pinning information

Pin	Simplified outline	Symbol
Pin1 cathode Pin2 anode		

Marking

Type number	Marking code
MURS160T3G	U1J

Suggested thermal profiles for soldering processes

- 1.Storage environment: Temperature=5°C~40°C Humidity=55%±25%
- 2.Reflow soldering of surface-mount devices

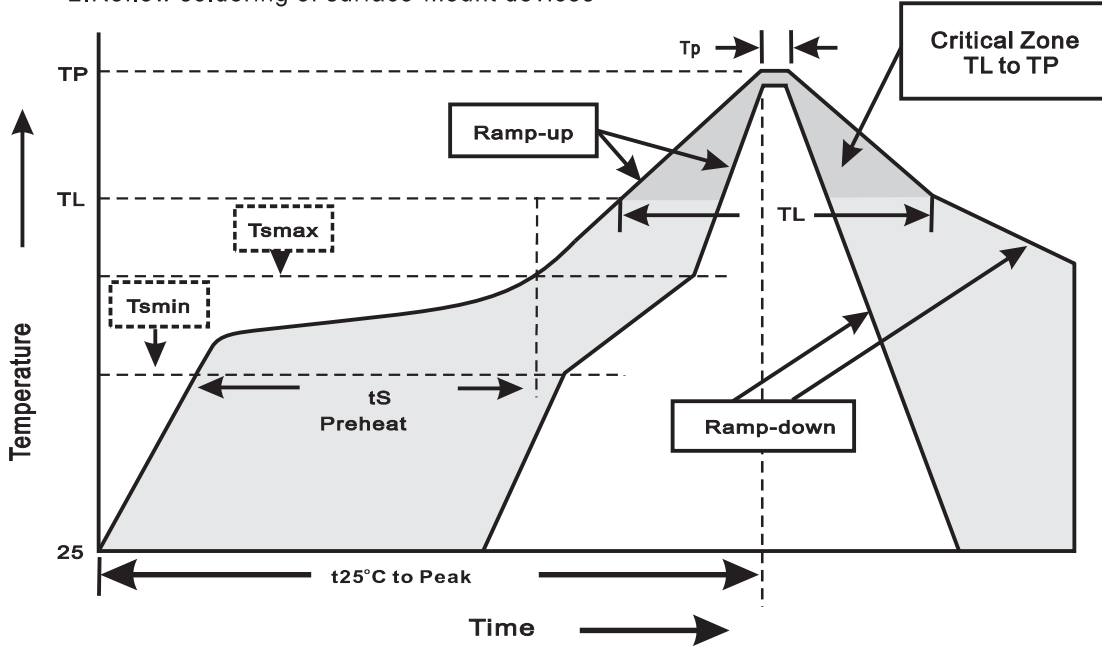

3.Reflow soldering

Profile Feature	Soldering Condition
Average ramp-up rate(T _L to T _P)	<3°C/sec
Preheat -Temperature Min(T _{smmin}) -Temperature Max(T _{smmax}) -Time(min to max)(t _s)	150°C 200°C 60~120sec
T _{smmax} to T _L -Ramp-upRate	<3°C/sec
Time maintained above: -Temperature(T _L) -Time(t _L)	217°C 60~260sec
Peak Temperature(T _P)	255°C-0/+5°C
Time within 5°C of actual Peak Temperature(t _P)	10~30sec
Ramp-down Rate	<6°C/sec
Time 25°C to Peak Temperature	<6minutes