

GENERAL DESCRIPTION

The GS2302 Series are a group of positive voltage regulators with high accuracy, low noise, high speed, low drop-out voltage regulator with Chip Enable Pin, high ripple rejection and fast discharge function.

The current limiter's fold-back circuit operates as a short circuit protection as well as the output current limiter for the output pin.

Output voltage is selectable from 0.8V to 5.0V, other output voltages are applicable as customer specified.

The GS2302 Series is available in SOT23, SOT23-3L, SOT23-5L and DFN1x1-4L packages.

FEATURES

- Output Accuracy: $\pm 1.5\%$
- Low Quiescent Current: 40uA
- Low Dropout Voltage: 42mV@100mA
- High PSRR: 90dB@1KHz
- ESD Rating(HBM): $\pm 8KV$
- Output Current: 500mA
- Excellent Line and Load Regulation
- Operating Voltage Range: from 1.5V to 7.0V
- Output Voltage Range: from 0.8V to 5.0V
- Over-Temperature Protection
- Current Limiting Protection
- Output Short-Circuit Protection
- Available in SOT23, SOT23-3L, SOT23-5L and DFN1x1-4L Packages

APPLICATIONS

- Battery-Powered Devices
- Reference Voltage Sources
- Other Low Voltage Power Suppliers

PIN DESCRIPTION:

PIN No				SYMBOL	DESCRIPTION
SOT23	SOT23-3L	SOT23-5L	DFN1x1-4L		
3	3	1	4	VIN	Power Supply Input
1	1	2	2,E-PAD	GND	Ground
--	--	3	3	EN	Chip Enable
--	--	4	--	NC	Not Connected
2	2	5	1	VOUT	Output

PIN ASSIGNMENT

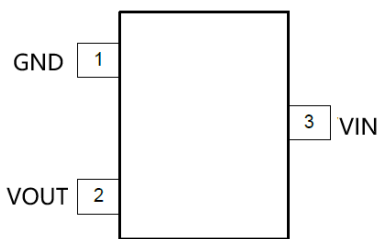

SOT23/SOT23-3L

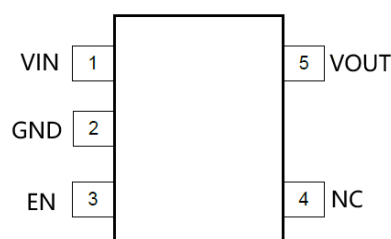

SOT23-5L

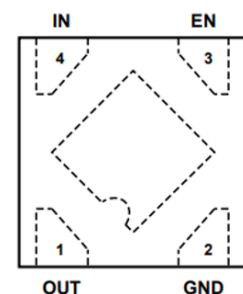

DFN1x1-4L

Order Information

Model	PIN-PACKAGE	Ordering Number	Packing Option
GS2302	SOT23/SOT23-3L	GS2302-XXTR3	3000pcs/Reel
	SOT23-5L	GS2302-XXTR5	3000pcs/Reel
	DFN1*1-4L	GS2302-XXFR4	10000pcs/Reel

Note:“XX”represents the type of voltage value.

TYPICAL APPLICATION CIRCUIT

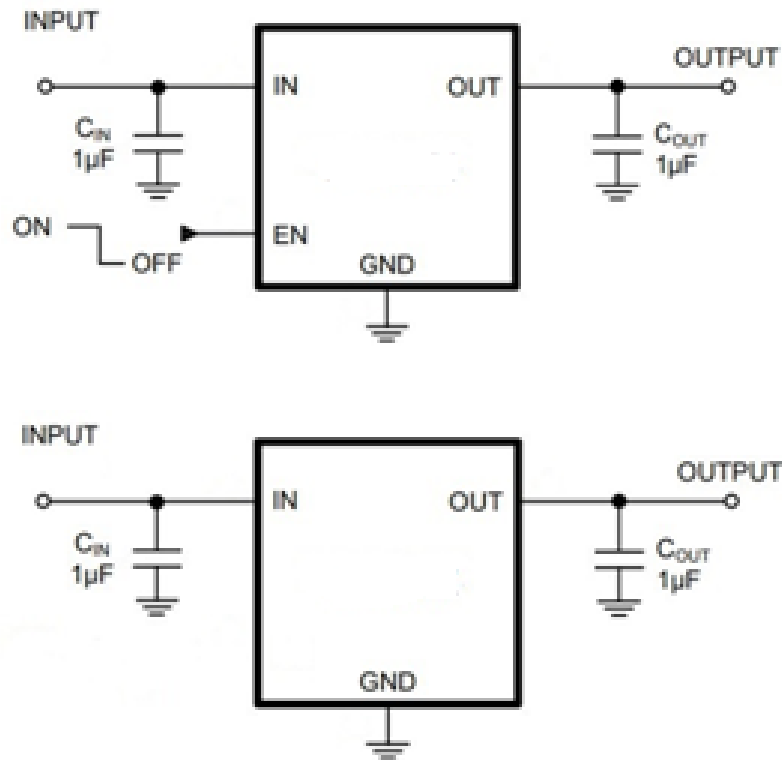

ABSOLUTE MAXIMUM RATINGS (Note 1):

SYMBOL	ITEM		RATING	UNIT
V_{IN}	Supply Voltage		-0.3~8.0	V
V_{OUT}	VOUT pin Voltage		-0.3~ ($V_{IN}+0.3$)	V
$V_{(ESD)}$	ESD Susceptibility, Human-body model ⁽²⁾		+/-8000	V
PD	Maximum Power Dissipation	SOT23	400	mW
		SOT23-3/5L	450	
		DFN1x1-4L	380	
PTR	Package Thermal Resistance Θ_{JA}	SOT23	312	°C/W
		SOT23-3/5L	278	
		DFN1x1-4L	328	
T_J	Junction Temperature Range		-40~150	°C
T_{STG}	Storage Temperature Range		-40~150	°C
T_{SOLDER}	Lead Temperature (Soldering, 10 Sec)		260	°C

Note:

1: Absolute Maximum Ratings are threshold limit values that must not be exceeded even for an instant under any condition. Moreover, such values for any two items must not be reached simultaneously. Operation above these absolute maximum ratings may cause degradation or permanent damage to the device. These are stress ratings only and do not necessarily imply functional operation below these limits.

2: per ANSI/ESDA/JEDEC JS-001

ELECTRICAL CHARACTERISTICS:

($V_{IN}=V_{OUT}+1V$, $C_{IN}=C_{OUT}=1\mu F$, $T_A=25^\circ C$, unless otherwise specified.)

Symbol	Parameter	Conditions	MIN	TYP	MAX	Units
V_{IN}	Input Voltage		1.5		7.0	V
V_{UVLO}	UVLO threshold			1.2		V
V_{OUT}	Output Accuracy	$V_{IN}=V_{OUT}+1V$, $I_{OUT}=1mA$	-1.5		+1.5	%
I_{LIM}	Current Limit	$V_{IN}=V_{OUT}+1V$	500	700		mA
I_Q	Quiescent Current	$V_{IN}=V_{OUT}+1V$, $V_{EN}=5V$, $I_{OUT}=0mA$		40	60	μA
I_{SHD}	Shutdown Current	$V_{EN}=0V$		0.01	0.1	μA
V_{DROP}	Dropout Voltage ⁽¹⁾	$I_{OUT}=100mA$		42		mV
		$I_{OUT}=300mA$		130		
		$I_{OUT}=500mA$		230		
S_{LINE}	Line Regulation	$V_{IN}=V_{OUT}+1.0V$ to $7.0V$, $I_{OUT}=1mA$		1	10	mV
S_{LOAD}	Load Regulation	$V_{IN}=V_{OUT}+1V$, $I_{OUT}=1mA$ to $500mA$		10		mV
I_{SHORT}	Short Current	$V_{OUT}=0V$		100		mA
V_{ENH}	EN High Voltage	$V_{IN}=1.5V$ to $7.0V$, $I_{OUT}=1mA$	1.4			V
V_{ENL}	EN Low Voltage				0.5	V
T_{STR}	Startup Time	From V_{EN} low to high to $V_{OUT}=95\%$ $C_{OUT}=1\mu F$, No load		25		μs
PSRR	Power Supply Rejection Ratio	$I_{OUT}=50mA$	$f=217Hz$		92	dB
			$f=1KHz$		90	
			$f=10KHz$		80	
e_{NO}	Output Noise Voltage	$f=10Hz$ to $100KHz$, $C_{OUT}=1\mu F$		50		μV_{RMS}
T_C	Output Voltage Temperature Coefficient	$I_{OUT}=10mA$, $T_A=-40\sim 120^\circ C$		± 0.1		$mV/^\circ C$
T_{SD}	Overheat protection	Shutdown, temperature increasing		150		$^\circ C$
$R_{DISCHRG}$	R_{ON} of Discharge MOSFET	$V_{IN}=V_{OUT}+1V$, $V_{EN}=0V$		200		Ω

Notes:

1.The dropout voltage is defined as $V_{IN} - V_{OUT}$, when $V_{OUT}=95\%*V_{OUT(NOW)}$.

SIMPLIFIED BLOCK DIAGRAM:

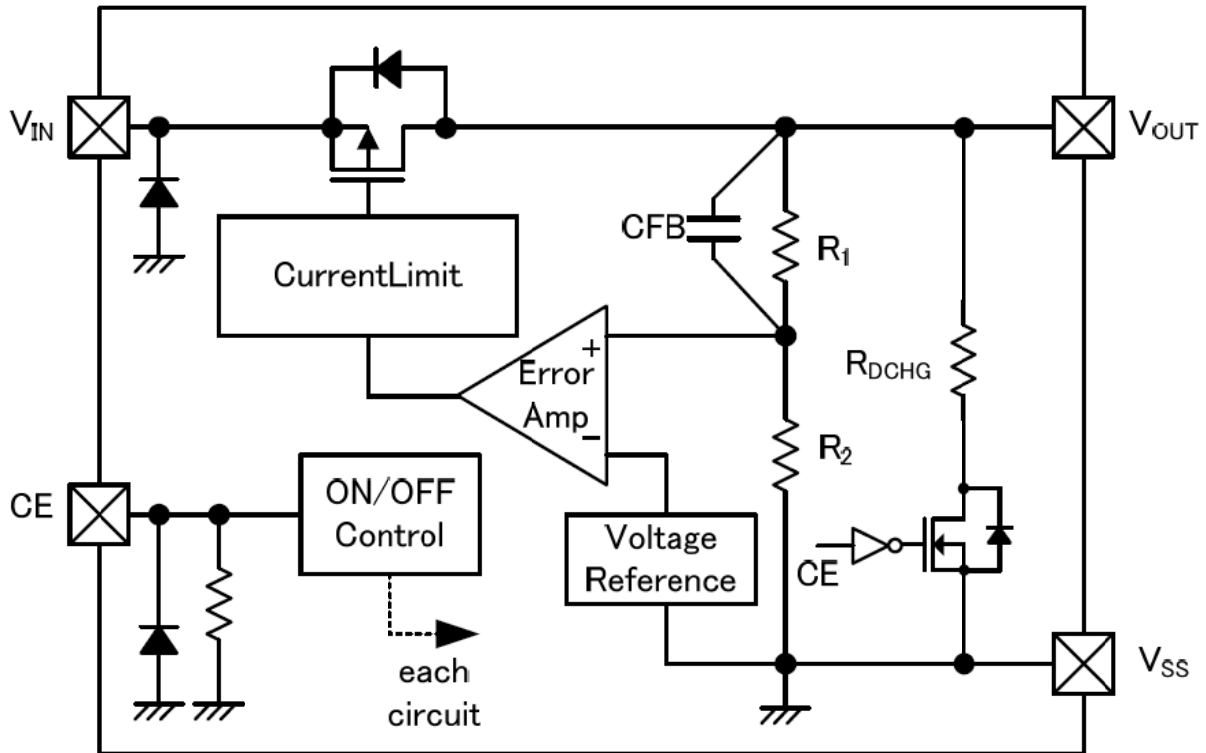

DETAIL OPERATION DESCRIPTION:

The GS2302 Series is a low power consumption low drop-out voltage regulator. It consists of a current limiter circuit, a driver transistor, a precision reference voltage and an error correction circuit, and is compatible with low ESR ceramic capacitors. The current limiter's fold-back circuit operates as a short circuit protection as well as the output current limiter.

Current Limiting and Short-Circuit Protection

The current limit circuitry prevents damage to the MOSFET switch and the hub downstream port but can deliver load current up to the current limit threshold of typically 700mA through the switch. When a heavy load or short circuit is applied to an enabled switch, a large transient current may flow until the current limit circuitry responds. Once this current limit threshold is exceeded the device enters constant current mode until the thermal shutdown occurs or the fault is removed.

TYPICAL OPERATING CHARACTERISTICS:

(Tested under $T_J = 25^\circ\text{C}$, unless otherwise specified)

1. V_{OUT} vs T_J

($V_{IN}=4.3\text{V}$, $V_{OUT}=3.3\text{V}$, $I_{OUT}=10\text{mA}$)

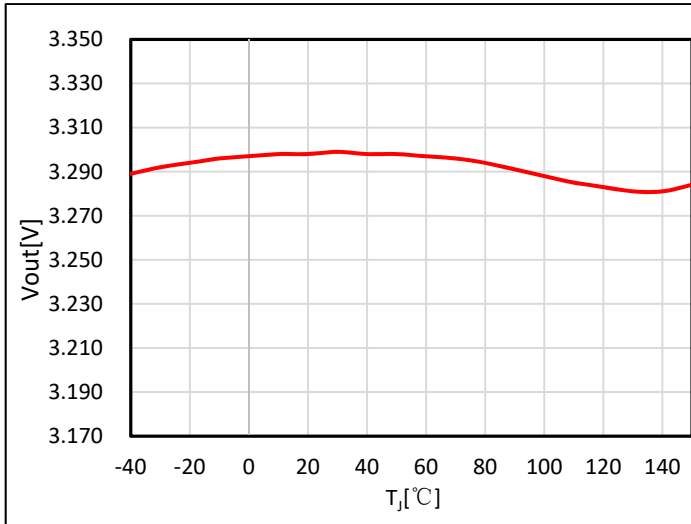

2. I_Q vs V_{IN}

($V_{OUT}=3.3\text{V}$, $I_{OUT}=0\text{mA}$)

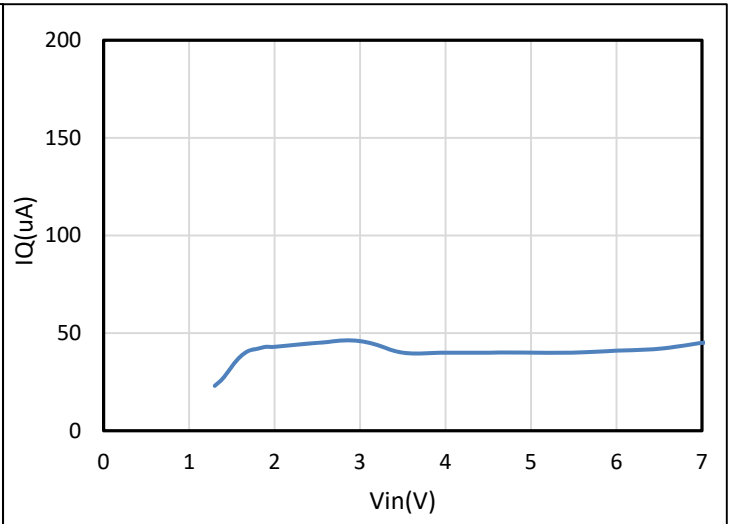

3. Load Regulation

($V_{IN}=4.3\text{V}$, $V_{OUT}=3.3\text{V}$, $I_{OUT}=0 \rightarrow 500\text{mA}$)

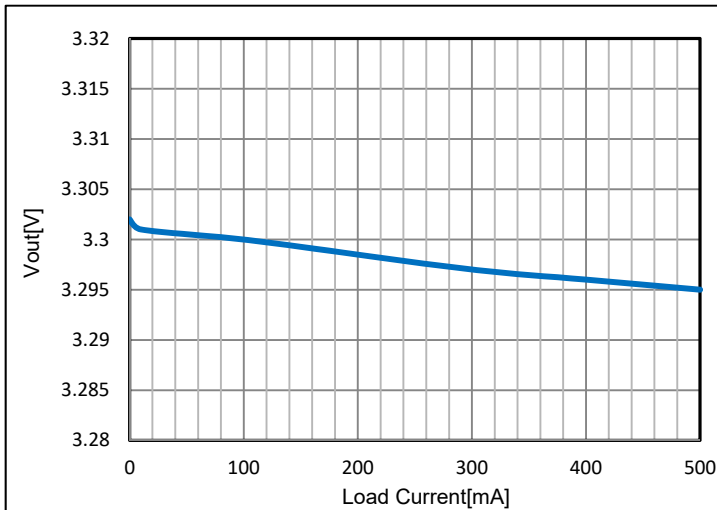

$I_{OUT}=1\text{mA}$)

4. Line Regulation

($V_{IN}=3.8\text{V} \rightarrow 7.0\text{V}$, $V_{OUT}=3.3\text{V}$,

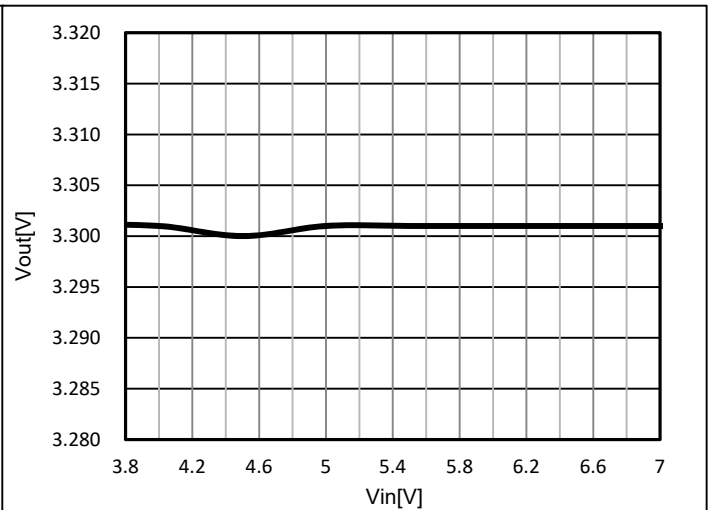

5. Dropout Voltage

($V_{EN}=4.3V$, $V_{OUT}=95\%*3.3V$, $I_{OUT}=0\rightarrow 500mA$)

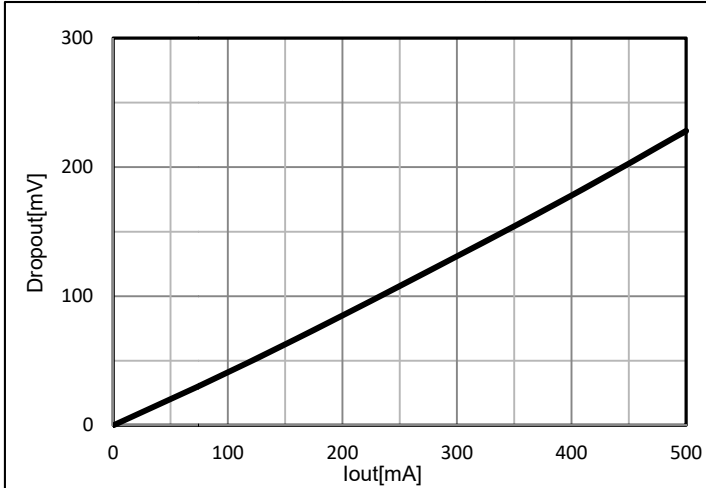

6. V_{EN} Thresholds vs V_{IN}

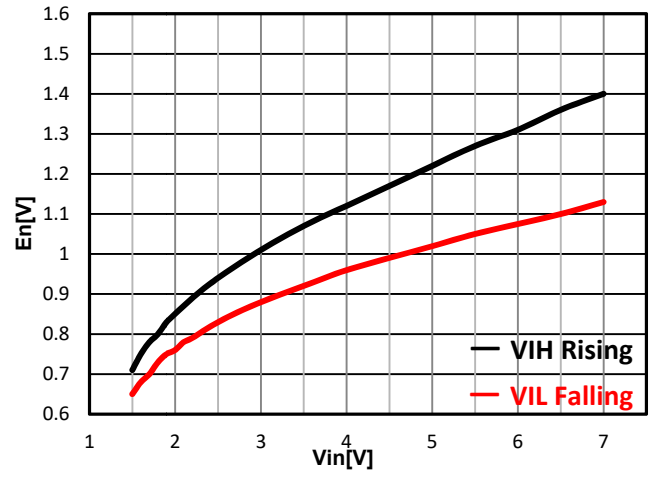

7. Line Transient

($V_{IN}=4.3V\rightarrow 6.0V$, $V_{OUT}=3.3V$, $I_{OUT}=1mA$)

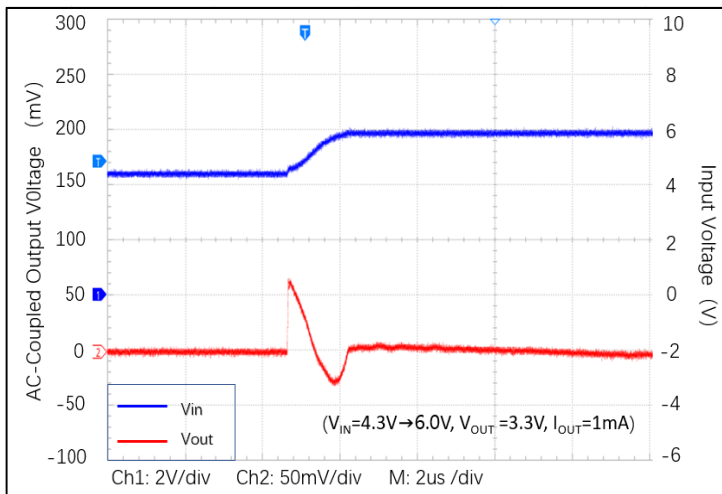

8. Load Transient

($V_{IN}=4.3V$, $V_{OUT}=3.3V$, $I_{OUT}=1\rightarrow 500mA$)

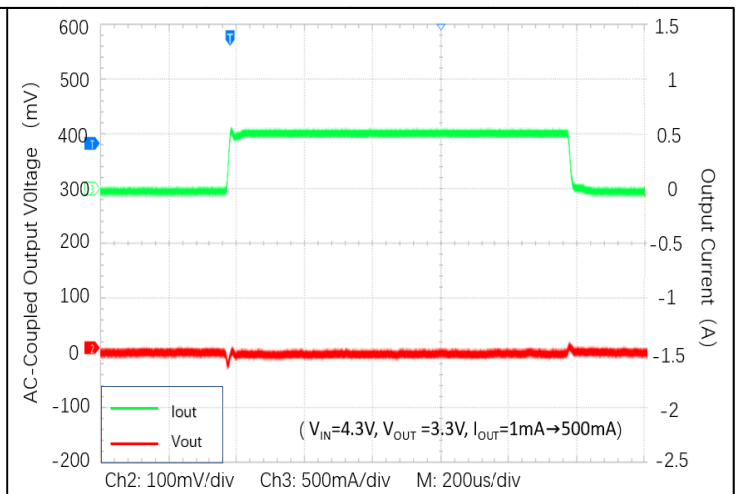

9. Start-Up

($V_{IN}=0V \rightarrow 4.3V$, $V_{OUT}=3.3V$, $I_{OUT}=0mA$)

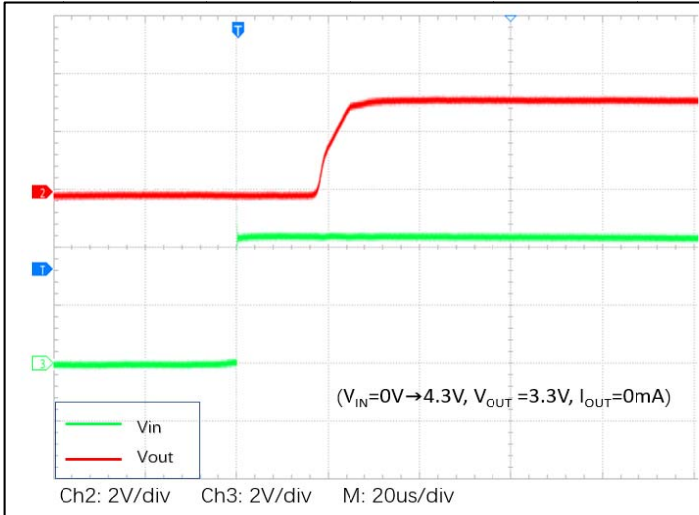

10. Start-Up

($V_{IN}=0V \rightarrow 4.3V$, $V_{OUT}=3.3V$, $I_{OUT}=500mA$)

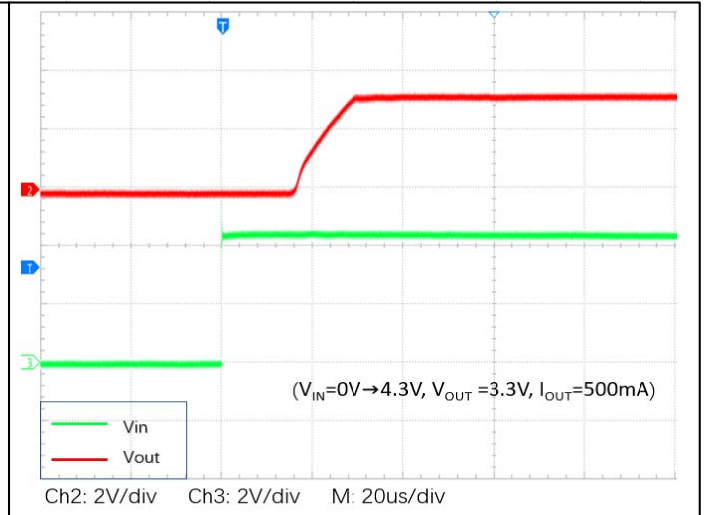

11. Shut-Down

($V_{EN}=4.3V \rightarrow 0V$, $V_{OUT}=3.3V$, $I_{OUT}=0mA$)

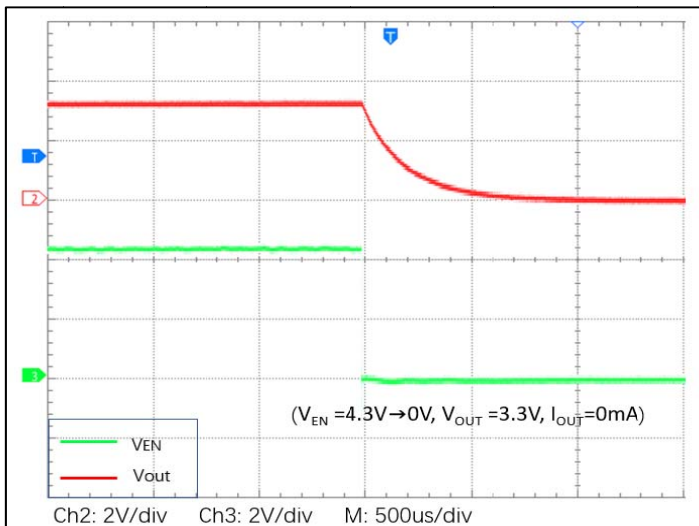

12. Shut-Down

($V_{EN}=4.3V \rightarrow 0V$, $V_{OUT}=3.3V$, $I_{OUT}=500mA$)

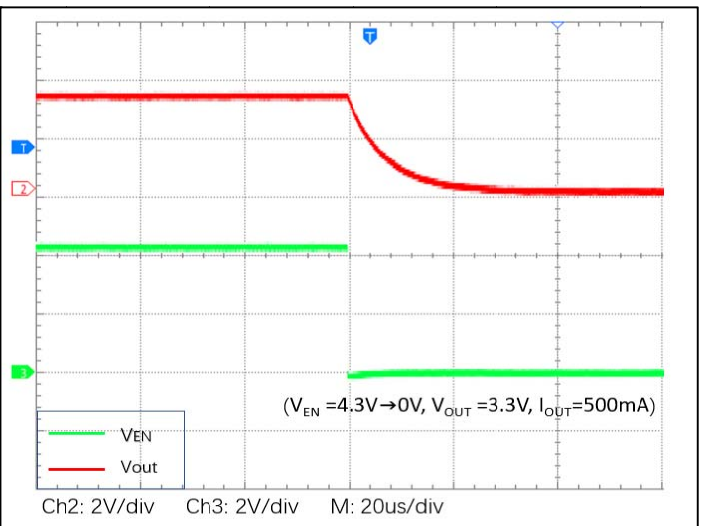

($V_{EN}=4.3V \rightarrow 0V$, $V_{OUT}=3.3V$, $I_{OUT}=0mA$)

($V_{EN}=4.3V \rightarrow 0V$, $V_{OUT}=3.3V$,

$I_{OUT}=500mA$)

13. PSRR

($V_{IN}=4.3V$, $V_{OUT}=3.3V$, $C_{IN}=none$, $C_{OUT}=1\mu F$)

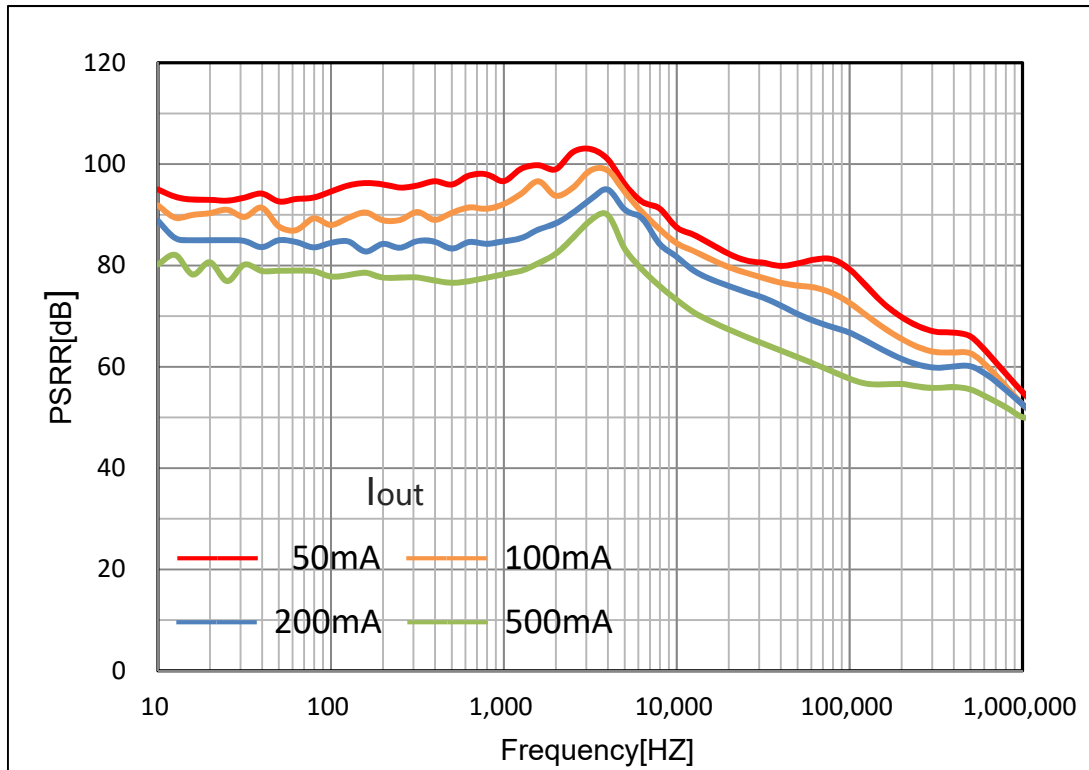

APPLICATION INFORMATION:**● Input Capacitor Selection**

Like any low-dropout regulator, the external capacitors used with the GS2302 Series must be carefully selected for regulator stability and performance. Using a capacitor whose value is $\geq 1\mu\text{F}$ on the GS2302 Series input and the amount of capacitance can be increased without limit. The input capacitor must be located a distance of not more than 0.5 inch from the input pin of the IC and returned to a clean analog ground. Any good quality ceramic or tantalum can be used for this capacitor. The capacitor with larger value and lower ESR (equivalent series resistance) provides better PSRR and line-transient response.

● Output Capacitor Selection

The output capacitor must meet both requirements for minimum amount of capacitance and ESR in all LDOs application. The GS2302 Series is designed specifically to work with low ESR ceramic output capacitor in space-saving and performance consideration. Using a ceramic capacitor whose value is at least $1\mu\text{F}$ on the GS2302 Series output ensures stability. Output capacitor of larger capacitance can reduce noise and improve load transient response, stability, and PSRR. The output capacitor should be located not more than 0.5 inch from the VOUT pin of the GS2302 Series and returned to a clean analog ground.

● Layout considerations

To improve ac performance such as PSRR, output noise, and transient response, it is recommended that the PCB be designed with separate ground planes for VIN and VOUT, with each ground plane connected only at the GND pin of the device.

PACKAGE OUTLINE:

SOT23 Package

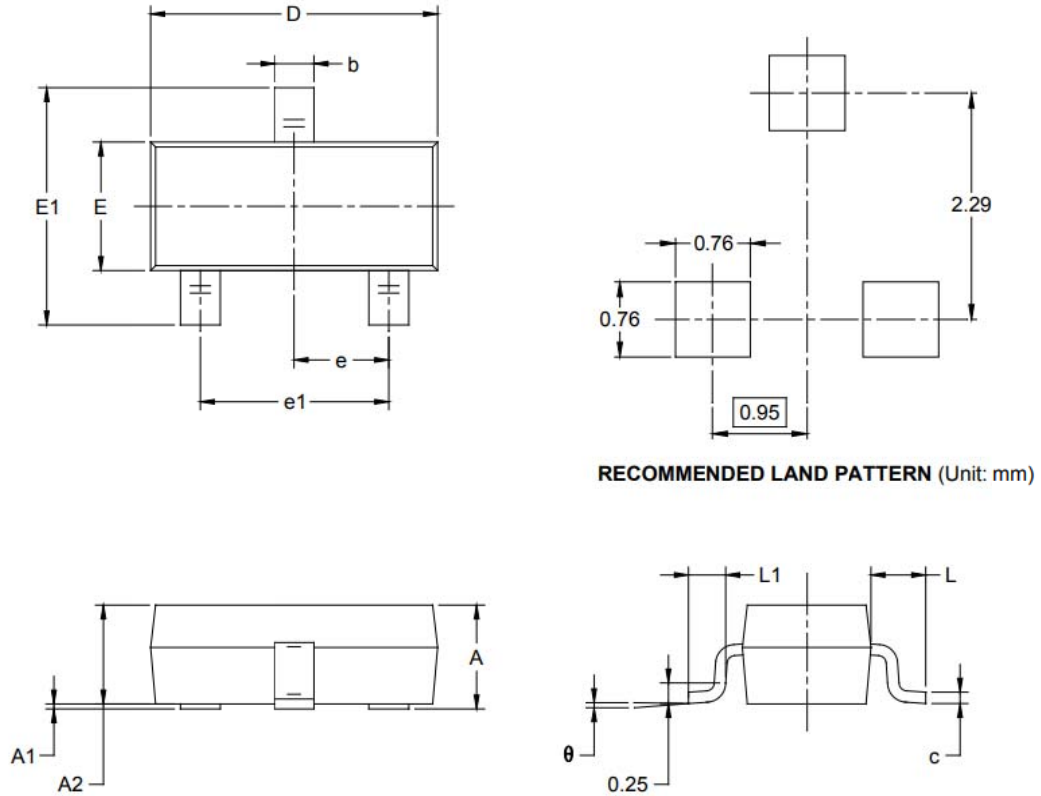

Symbol	Dimensions In Millimeters		Dimensions In Inches	
	MIN	MAX	MIN	MAX
A	0.900	1.150	0.035	0.045
A1	0.000	0.100	0.000	0.004
A2	0.900	1.050	0.035	0.041
b	0.300	0.500	0.012	0.020
c	0.080	0.150	0.003	0.006
D	2.800	3.000	0.110	0.118
E	1.200	1.400	0.047	0.055
E1	2.250	2.550	0.089	0.100
e	0.950 BSC		0.037 BSC	
e1	1.900 BSC		0.075 BSC	
L	0.550 REF		0.022 REF	
L1	0.300	0.500	0.012	0.020
θ	0°	8°	0°	8°

SOT23-3L Package

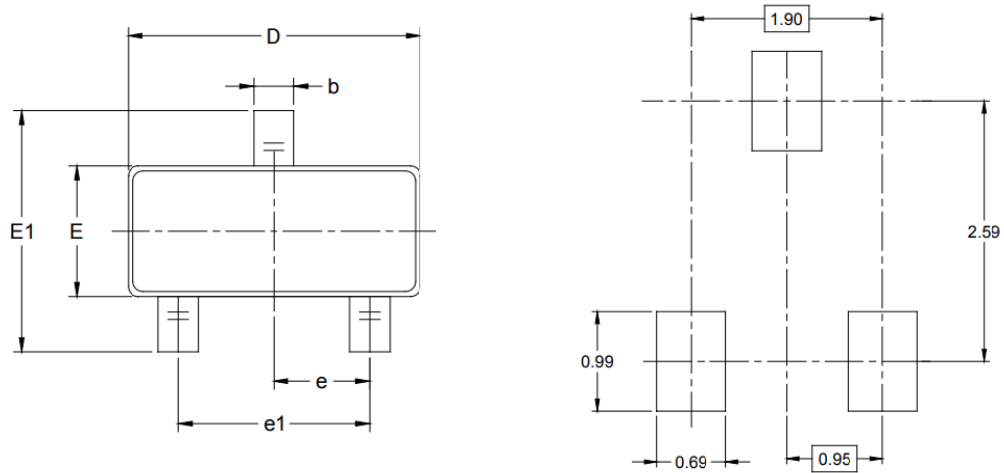

RECOMMENDED LAND PATTERN (Unit: mm)

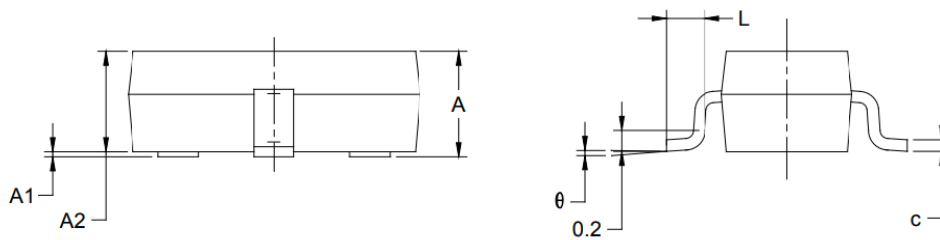

Symbol	Dimensions In Millimeters		Dimensions In Inches	
	MIN	MAX	MIN	MAX
A	1.050	1.250	0.041	0.049
A1	0.000	0.100	0.000	0.004
A2	1.050	1.150	0.041	0.045
b	0.300	0.500	0.012	0.020
c	0.100	0.200	0.004	0.008
D	2.820	3.020	0.111	0.119
E	1.500	1.700	0.059	0.067
E1	2.650	2.950	0.104	0.116
e	0.950 BSC		0.037 BSC	
e1	1.900 BSC		0.075 BSC	
L	0.300	0.600	0.012	0.024
θ	0°	8°	0°	8°

SOT23-5L Package

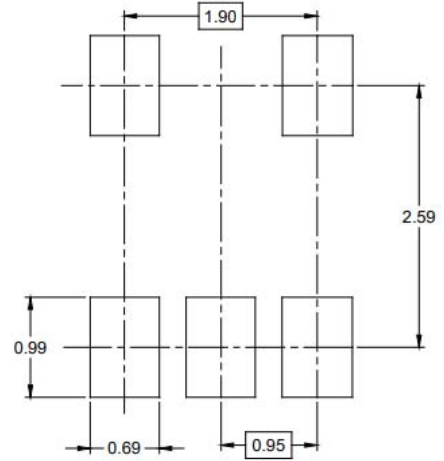
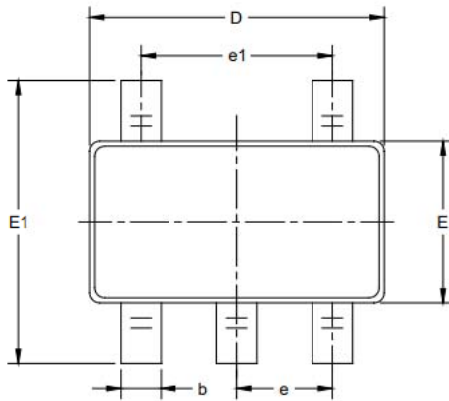

RECOMMENDED LAND PATTERN (Unit: mm)

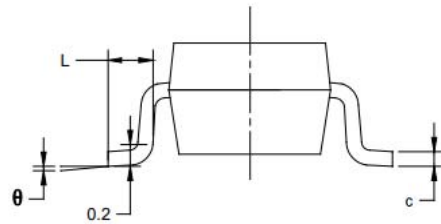
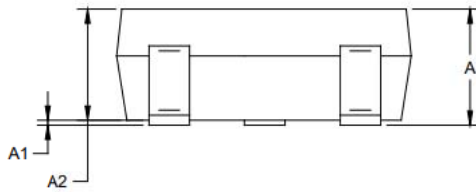

Symbol	Dimensions In Millimeters		Dimensions In Inches	
	MIN	MAX	MIN	MAX
A	1.050	1.250	0.041	0.049
A1	0.000	0.100	0.000	0.004
A2	1.050	1.150	0.041	0.045
b	0.300	0.500	0.012	0.020
c	0.100	0.200	0.004	0.008
D	2.820	3.020	0.111	0.119
E	1.500	1.700	0.059	0.067
E1	2.650	2.950	0.104	0.116
e	0.950 BSC		0.037 BSC	
e1	1.900 BSC		0.075 BSC	
L	0.300	0.600	0.012	0.024
θ	0°	8°	0°	8°

DFN1x1-4L Package

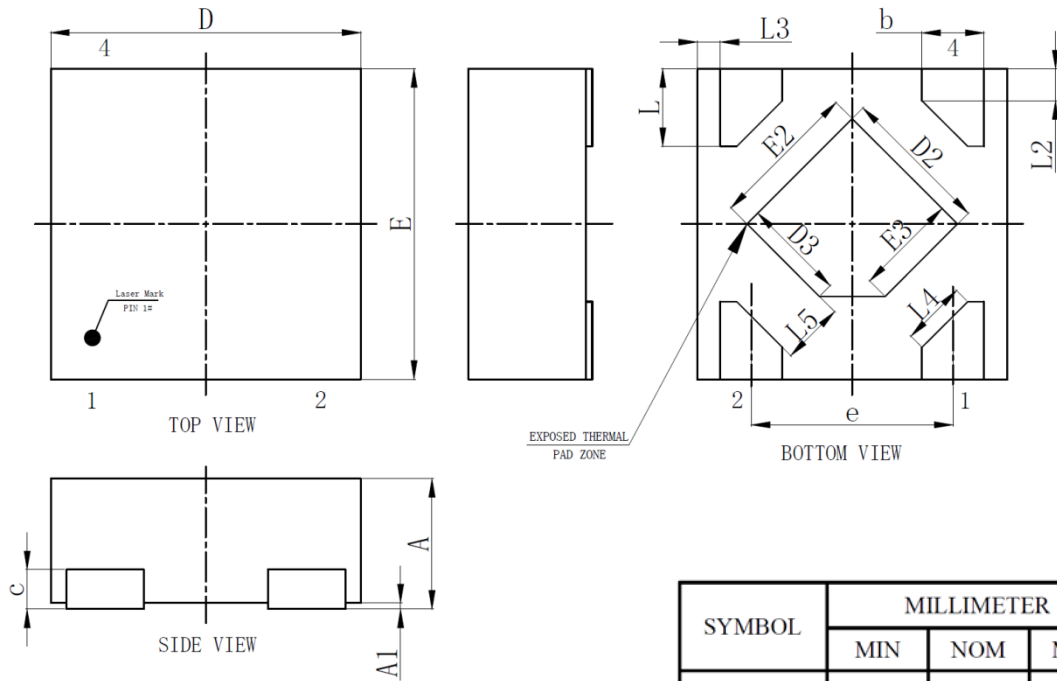

SYMBOL	MILLIMETER		
	MIN	NOM	MAX
A	0.35	-	0.40
A1	0.00	0.02	0.05
b	0.15	0.20	0.25
c	0.127REF		
D	0.95	1.00	1.05
D2	0.38	0.48	0.58
D3	0.23	0.33	0.43
e	0.65BSC		
E	0.95	1.00	1.05
E2	0.38	0.48	0.58
E3	0.23	0.33	0.43
L	0.20	0.25	0.30
L2	0.103REF		
L3	0.075REF		
L4	0.208REF		
L5	0.200REF		