



# AiP74HC/HCT14

## Hex Inverting Schmitt Trigger

### Product Specification

**Specification Revision History:**

Version	Date	Description
2019-05-A1	2019-05	New
2021-11-A2	2021-11	Modify ambient temperature to -40°C~+105°C and add electrical characteristics of -40°C~+105°C; Modify ordering information
2021-12-A3	2021-12	Modify ordering information
2022-03-A4	2022-03	Modify reel packing specifications for TSSOP14



## 1、 General Description

The AiP74HC/HCT14 is a hex inverter with Schmitt-trigger inputs. This device features reduced input threshold levels to allow interfacing to TTL logic levels. Inputs include clamp diodes. This enables the use of current limiting resistors to interface inputs to voltages in excess of  $V_{CC}$ . Schmitt trigger inputs transform slowly changing input signals into sharply defined jitter-free output signals.

### Features:

- Input levels:
  - For AiP74HC14: CMOS level
  - For AiP74HCT14: TTL level
- Low-power dissipation
- Specified from  $-40^{\circ}\text{C}$  to  $+105^{\circ}\text{C}$
- Packaging information: DIP14/SOP14/TSSOP14

**Ordering Information:****Tube packing specifications:**

Part number	Packaging form	Marking code	Tube quantity	Boxed tube quantity	Boxed quantity	Notes
AiP74HC14DA14.TB	DIP14	74HC14	25 PCS/tube	40 tube/box	1000 PCS/box	Dimensions of plastic enclosure: 19.0mm×6.4mm Pin spacing: 2.54mm
AiP74HCT14DA14.TB	DIP14	74HCT14	25 PCS/tube	40 tube/box	1000 PCS/box	Dimensions of plastic enclosure: 19.0mm×6.4mm Pin spacing: 2.54mm
AiP74HC14SA14.TB	SOP14	74HC14	50 PCS/tube	200 tube/box	10000 PCS/box	Dimensions of plastic enclosure: 8.7mm×3.9mm Pin spacing: 1.27mm
AiP74HCT14SA14.TB	SOP14	74HCT14	50 PCS/tube	200 tube/box	10000 PCS/box	Dimensions of plastic enclosure: 8.7mm×3.9mm Pin spacing: 1.27mm
AiP74HC14TA14.TB	TSSOP14	74HC14	94 PCS/tube	200 tube/box	18800 PCS/box	Dimensions of plastic enclosure: 5.0mm×4.4mm Pin spacing: 0.65mm
AiP74HCT14TA14.TB	TSSOP14	74HCT14	94 PCS/tube	200 tube/box	18800 PCS/box	Dimensions of plastic enclosure: 5.0mm×4.4mm Pin spacing: 0.65mm

**Reel packing specifications:**

Part number	Packaging form	Marking code	Reel quantity	Boxed reel quantity	Notes
AiP74HC14SA14.TR	SOP14	74HC14	4000 PCS/reel	8000 PCS/box	Dimensions of plastic enclosure: 8.7mm×3.9mm Pin spacing: 1.27mm
AiP74HCT14SA14.TR	SOP14	74HCT14	4000 PCS/reel	8000 PCS/box	Dimensions of plastic enclosure: 8.7mm×3.9mm Pin spacing: 1.27mm
AiP74HC14TA14.TR	TSSOP14	74HC14	5000 PCS/reel	10000 PCS/box	Dimensions of plastic enclosure: 5.0mm×4.4mm Pin spacing: 0.65mm
AiP74HCT14TA14.TR	TSSOP14	74HCT14	5000 PCS/reel	10000 PCS/box	Dimensions of plastic enclosure: 5.0mm×4.4mm Pin spacing: 0.65mm

Note: If the physical information is inconsistent with the ordering information, please refer to the actual product.



## 2、Block Diagram And Pin Description

### 2.1、Block Diagram

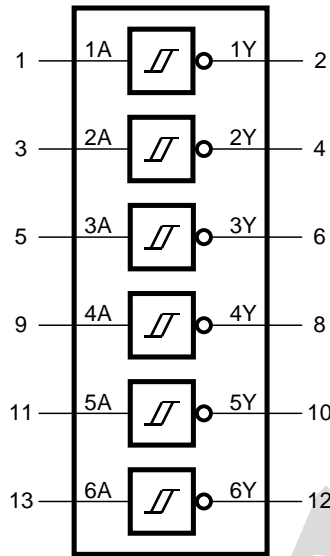

Figure 1. Logic symbol

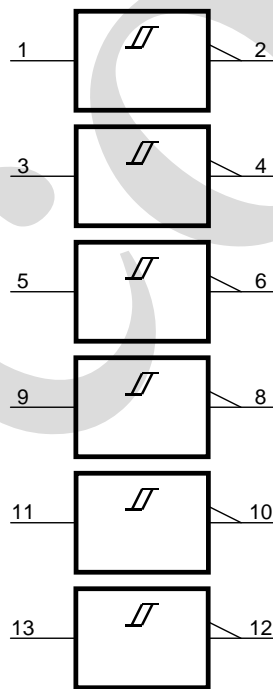

Figure 2. IEC logic symbol

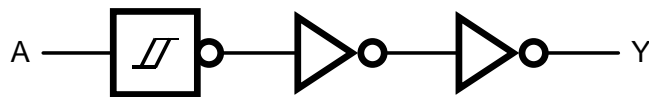
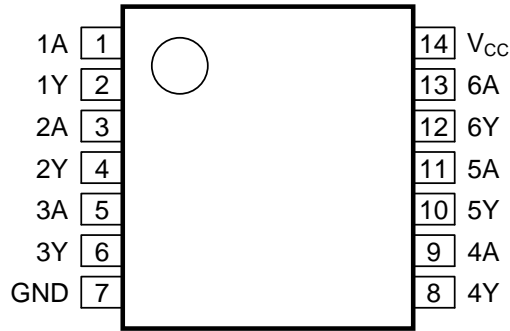

Figure 3. Logic diagram for one gate



## 2.2、Pin Configurations



## 2.3、Pin Description

Pin No.	Pin Name	Description
1	1A	data input
2	1Y	data output
3	2A	data input
4	2Y	data output
5	3A	data input
6	3Y	data output
7	GND	ground (0V)
8	4Y	data output
9	4A	data input
10	5Y	data output
11	5A	data input
12	6Y	data output
13	6A	data input
14	V <sub>CC</sub>	supply voltage

## 2.4、Function Table

Input	Output
nA	nY
L	H
H	L

Note: H=HIGH voltage level; L=LOW voltage level.



## 3、Electrical Parameter

### 3.1、Absolute Maximum Ratings

(Voltages are referenced to GND (ground=0V), unless otherwise specified.)

Parameter	Symbol	Conditions	Min.	Max.	Unit
supply voltage	$V_{CC}$	-	-0.5	+7	V
input clamping current	$I_{IK}$	$V_I < -0.5V$ or $V_I > V_{CC}+0.5V$	-	$\pm 20$	mA
output clamping current	$I_{OK}$	$V_O < -0.5V$ or $V_O > V_{CC}+0.5V$	-	$\pm 20$	mA
output current	$I_O$	$-0.5V < V_O < V_{CC}+0.5V$	-	$\pm 25$	mA
supply current	$I_{CC}$	-	-	50	mA
ground current	$I_{GND}$	-	-50	-	mA
total power dissipation	$P_{tot}$	-	-	500	mW
storage temperature	$T_{stg}$	-	-65	+150	$^{\circ}C$
soldering temperature	$T_L$	10s	DIP	245	$^{\circ}C$
			SOP	250	

Note:

[1] For DIP14 packages: above  $70^{\circ}C$  the value of  $P_{tot}$  derates linearly with 12mW/K.

[2] For SOP14 packages: above  $70^{\circ}C$  the value of  $P_{tot}$  derates linearly with 8mW/K.

[3] For (T)SSOP14 packages: above  $60^{\circ}C$  the value of  $P_{tot}$  derates linearly with 5.5mW/K.

### 3.2、Recommended Operating Conditions

Parameter	Symbol	Conditions	Min.	Typ.	Max.	Unit
<b>AiP74HC14</b>						
supply voltage	$V_{CC}$	-	2.0	5.0	6.0	V
input voltage	$V_I$	-	0	-	$V_{CC}$	V
output voltage	$V_O$	-	0	-	$V_{CC}$	V
input transition rise and fall rate	$\Delta t/\Delta V$	$V_{CC}=2.0V$	-	-	625	ns/V
		$V_{CC}=4.5V$	-	1.67	139	ns/V
		$V_{CC}=6.0V$	-	-	83	ns/V
ambient temperature	$T_{amb}$	-	-40	-	+105	$^{\circ}C$
<b>AiP74HCT14</b>						
supply voltage	$V_{CC}$	-	4.5	5.0	5.5	V
input voltage	$V_I$	-	0	-	$V_{CC}$	V
output voltage	$V_O$	-	0	-	$V_{CC}$	V
input transition rise and fall rate	$\Delta t/\Delta V$	$V_{CC}=4.5V$	-	1.67	139	ns/V
ambient temperature	$T_{amb}$	-	-40	-	+105	$^{\circ}C$



### 3.3、Electrical Characteristics

#### 3.3.1、DC Characteristics 1

( $T_{amb}=25^{\circ}\text{C}$ , voltages are referenced to GND (ground=0V), unless otherwise specified.)

Parameter	Symbol	Conditions	Min.	Typ.	Max.	Unit	
<b>AiP74HC14</b>							
HIGH-level output voltage	$V_{OH}$	$V_I=V_{T+}$ or $V_{T-}$	$I_O=-20\mu\text{A}; V_{CC}=2.0\text{V}$	1.9	2.0	-	V
			$I_O=-20\mu\text{A}; V_{CC}=4.5\text{V}$	4.4	4.5	-	V
			$I_O=-20\mu\text{A}; V_{CC}=6.0\text{V}$	5.9	6.0	-	V
			$I_O=-4.0\text{mA}; V_{CC}=4.5\text{V}$	3.98	4.32	-	V
			$I_O=-5.2\text{mA}; V_{CC}=6.0\text{V}$	5.48	5.81	-	V
LOW-level output voltage	$V_{OL}$	$V_I=V_{T+}$ or $V_{T-}$	$I_O=20\mu\text{A}; V_{CC}=2.0\text{V}$	-	0	0.1	V
			$I_O=20\mu\text{A}; V_{CC}=4.5\text{V}$	-	0	0.1	V
			$I_O=20\mu\text{A}; V_{CC}=6.0\text{V}$	-	0	0.1	V
			$I_O=4.0\text{mA}; V_{CC}=4.5\text{V}$	-	0.15	0.26	V
			$I_O=5.2\text{mA}; V_{CC}=6.0\text{V}$	-	0.16	0.26	V
input leakage current	$I_I$	$V_I=V_{CC}$ or GND; $V_{CC}=6.0\text{V}$	-	-	$\pm 0.1$	$\mu\text{A}$	
supply current	$I_{CC}$	$V_I=V_{CC}$ or GND; $I_O=0\text{A}$ ; $V_{CC}=6.0\text{V}$	-	-	2.0	$\mu\text{A}$	
input capacitance	$C_I$	-	-	3.5	-	pF	
<b>AiP74HCT14</b>							
HIGH-level output voltage	$V_{OH}$	$V_I=V_{T+}$ or $V_{T-}$	$I_O=-20\mu\text{A}; V_{CC}=4.5\text{V}$	4.4	4.5	-	V
			$I_O=-4.0\text{mA}; V_{CC}=4.5\text{V}$	3.98	4.32	-	V
LOW-level output voltage	$V_{OL}$	$V_I=V_{T+}$ or $V_{T-}$	$I_O=20\mu\text{A}; V_{CC}=4.5\text{V}$	-	0	0.1	V
			$I_O=4.0\text{mA}; V_{CC}=4.5\text{V}$	-	0.15	0.26	V
input leakage current	$I_I$	$V_I=V_{CC}$ or GND; $V_{CC}=5.5\text{V}$	-	-	$\pm 0.1$	$\mu\text{A}$	
supply current	$I_{CC}$	$V_I=V_{CC}$ or GND; $I_O=0\text{A}$ ; $V_{CC}=5.5\text{V}$	-	-	2.0	$\mu\text{A}$	
additional supply current	$\Delta I_{CC}$	per input pin; $V_I=V_{CC}-2.1\text{V}$ ; $I_O=0\text{A}$ ; other inputs at $V_{CC}$ or GND; $V_{CC}=4.5\text{V}$ to $5.5\text{V}$	-	30	108	$\mu\text{A}$	
input capacitance	$C_I$	-	-	3.5	-	pF	





### 3.3.2、DC Characteristics 2

( $T_{amb} = -40^{\circ}\text{C}$  to  $+85^{\circ}\text{C}$ , voltages are referenced to GND (ground=0V), unless otherwise specified.)

Parameter	Symbol	Conditions	Min.	Typ.	Max.	Unit	
<b>AiP74HC14</b>							
HIGH-level output voltage	$V_{OH}$	$V_I = V_{T+}$ or $V_{T-}$	$I_O = -20\mu\text{A}; V_{CC} = 2.0\text{V}$	1.9	-	-	V
			$I_O = -20\mu\text{A}; V_{CC} = 4.5\text{V}$	4.4	-	-	V
			$I_O = -20\mu\text{A}; V_{CC} = 6.0\text{V}$	5.9	-	-	V
			$I_O = -4.0\text{mA}; V_{CC} = 4.5\text{V}$	3.84	-	-	V
			$I_O = -5.2\text{mA}; V_{CC} = 6.0\text{V}$	5.34	-	-	V
LOW-level output voltage	$V_{OL}$	$V_I = V_{T+}$ or $V_{T-}$	$I_O = 20\mu\text{A}; V_{CC} = 2.0\text{V}$	-	-	0.1	V
			$I_O = 20\mu\text{A}; V_{CC} = 4.5\text{V}$	-	-	0.1	V
			$I_O = 20\mu\text{A}; V_{CC} = 6.0\text{V}$	-	-	0.1	V
			$I_O = 4.0\text{mA}; V_{CC} = 4.5\text{V}$	-	-	0.33	V
			$I_O = 5.2\text{mA}; V_{CC} = 6.0\text{V}$	-	-	0.33	V
input leakage current	$I_I$	$V_I = V_{CC}$ or GND; $V_{CC} = 6.0\text{V}$	-	-	$\pm 1$	$\mu\text{A}$	
supply current	$I_{CC}$	$V_I = V_{CC}$ or GND; $I_O = 0\text{A};$ $V_{CC} = 6.0\text{V}$	-	-	20	$\mu\text{A}$	
<b>AiP74HCT14</b>							
HIGH-level output voltage	$V_{OH}$	$V_I = V_{T+}$ or $V_{T-}$	$I_O = -20\mu\text{A}; V_{CC} = 4.5\text{V}$	4.4	-	-	V
			$I_O = -4.0\text{mA};$ $V_{CC} = 4.5\text{V}$	3.84	-	-	V
LOW-level output voltage	$V_{OL}$	$V_I = V_{T+}$ or $V_{T-}$	$I_O = 20\mu\text{A}; V_{CC} = 4.5\text{V}$	-	-	0.1	V
			$I_O = 4.0\text{mA}; V_{CC} = 4.5\text{V}$	-	-	0.33	V
input leakage current	$I_I$	$V_I = V_{CC}$ or GND; $V_{CC} = 5.5\text{V}$	-	-	$\pm 1$	$\mu\text{A}$	
supply current	$I_{CC}$	$V_I = V_{CC}$ or GND; $I_O = 0\text{A};$ $V_{CC} = 5.5\text{V}$	-	-	20	$\mu\text{A}$	
additional supply current	$\Delta I_{CC}$	per input pin; $V_I = V_{CC} - 2.1\text{V};$ $I_O = 0\text{A};$ other inputs at $V_{CC}$ or GND; $V_{CC} = 4.5\text{V}$ to $5.5\text{V}$	-	-	135	$\mu\text{A}$	



### 3.3.3、DC Characteristics 3

( $T_{amb} = -40^{\circ}\text{C}$  to  $+105^{\circ}\text{C}$ , voltages are referenced to GND (ground=0V), unless otherwise specified.)

Parameter	Symbol	Conditions	Min.	Typ.	Max.	Unit	
<b>AiP74HC14</b>							
HIGH-level output voltage	$V_{OH}$	$V_I = V_{T+}$ or $V_{T-}$	$I_O = -20\mu\text{A}; V_{CC} = 2.0\text{V}$	1.9	-	-	V
			$I_O = -20\mu\text{A}; V_{CC} = 4.5\text{V}$	4.4	-	-	V
			$I_O = -20\mu\text{A}; V_{CC} = 6.0\text{V}$	5.9	-	-	V
			$I_O = -4.0\text{mA}; V_{CC} = 4.5\text{V}$	3.7	-	-	V
			$I_O = -5.2\text{mA}; V_{CC} = 6.0\text{V}$	5.2	-	-	V
LOW-level output voltage	$V_{OL}$	$V_I = V_{T+}$ or $V_{T-}$	$I_O = 20\mu\text{A}; V_{CC} = 2.0\text{V}$	-	-	0.1	V
			$I_O = 20\mu\text{A}; V_{CC} = 4.5\text{V}$	-	-	0.1	V
			$I_O = 20\mu\text{A}; V_{CC} = 6.0\text{V}$	-	-	0.1	V
			$I_O = 4.0\text{mA}; V_{CC} = 4.5\text{V}$	-	-	0.4	V
			$I_O = 5.2\text{mA}; V_{CC} = 6.0\text{V}$	-	-	0.4	V
input leakage current	$I_I$	$V_I = V_{CC}$ or GND; $V_{CC} = 6.0\text{V}$	-	-	$\pm 1$	$\mu\text{A}$	
supply current	$I_{CC}$	$V_I = V_{CC}$ or GND; $I_O = 0\text{A}$ ; $V_{CC} = 6.0\text{V}$	-	-	40	$\mu\text{A}$	
<b>AiP74HCT14</b>							
HIGH-level output voltage	$V_{OH}$	$V_I = V_{T+}$ or $V_{T-}$	$I_O = -20\mu\text{A}; V_{CC} = 4.5\text{V}$	4.4	-	-	V
			$I_O = -4.0\text{mA}; V_{CC} = 4.5\text{V}$	3.7	-	-	V
LOW-level output voltage	$V_{OL}$	$V_I = V_{T+}$ or $V_{T-}$	$I_O = 20\mu\text{A}; V_{CC} = 4.5\text{V}$	-	-	0.1	V
			$I_O = 4.0\text{mA}; V_{CC} = 4.5\text{V}$	-	-	0.4	V
input leakage current	$I_I$	$V_I = V_{CC}$ or GND; $V_{CC} = 5.5\text{V}$	-	-	$\pm 1$	$\mu\text{A}$	
supply current	$I_{CC}$	$V_I = V_{CC}$ or GND; $I_O = 0\text{A}$ ; $V_{CC} = 5.5\text{V}$	-	-	40	$\mu\text{A}$	
additional supply current	$\Delta I_{CC}$	per input pin; $V_I = V_{CC} - 2.1\text{V}$ ; $I_O = 0\text{A}$ ; other inputs at $V_{CC}$ or GND; $V_{CC} = 4.5\text{V}$ to $5.5\text{V}$	-	-	147	$\mu\text{A}$	



### 3.3.4、AC Characteristics 1

( $T_{amb}=25^{\circ}\text{C}$ , voltages are referenced to GND (ground=0V), unless otherwise specified.)

Parameter	Symbol	Conditions	Min.	Typ.	Max.	Unit	
<b>AiP74HC14</b>							
nA, nB to nY propagation delay	$t_{pd}$	see Figure 5 <sup>[1]</sup>	$V_{CC}=2.0\text{V}$	-	41	125	ns
			$V_{CC}=4.5\text{V}$	-	15	25	ns
			$V_{CC}=5.0\text{V}; C_L=15\text{pF}$	-	12	-	ns
			$V_{CC}=6.0\text{V}$	-	12	21	ns
transition time	$t_t$	see Figure 5 <sup>[2]</sup>	$V_{CC}=2.0\text{V}$	-	19	75	ns
			$V_{CC}=4.5\text{V}$	-	7	15	ns
			$V_{CC}=6.0\text{V}$	-	6	13	ns
power dissipation capacitance	$C_{PD}$	per package; $V_I = \text{GND to } V_{CC}$ <sup>[3]</sup>	-	7	-	pF	
<b>AiP74HCT14</b>							
nA, nB to nY propagation delay	$t_{pd}$	see Figure 5 <sup>[1]</sup>	$V_{CC}=4.5\text{V}$	-	20	34	ns
			$V_{CC}=5.0\text{V}; C_L=15\text{pF}$	-	17	-	ns
transition time	$t_t$	see Figure 5 <sup>[2]</sup>	$V_{CC}=4.5\text{V}$	-	7	15	ns
power dissipation capacitance	$C_{PD}$	per package; $V_I = \text{GND to } V_{CC}-1.5\text{V}$ <sup>[3]</sup>	-	8	-	pF	

Note:

[1]  $t_{pd}$  is the same as  $t_{PLH}$  and  $t_{PHL}$ .

[2]  $t_t$  is the same as  $t_{THL}$  and  $t_{TLH}$ .

[3]  $C_{PD}$  is used to determine the dynamic power dissipation ( $P_D$  in uW).

$$P_D = (C_{PD} \times V_{CC}^2 \times f_i \times N) + \sum (C_L \times V_{CC}^2 \times f_o) \text{ where:}$$

$f_i$ =input frequency in MHz;

$f_o$ =output frequency in MHz;

$C_L$ =output load capacitance in pF;

$V_{CC}$ =supply voltage in V;

$N$ =number of inputs switching;

$\sum (C_L \times V_{CC}^2 \times f_o)$ =sum of outputs.



### 3.3.5、AC Characteristics 2

( $T_{amb}=-40^{\circ}\text{C}$  to  $+85^{\circ}\text{C}$ , voltages are referenced to GND (ground=0V), unless otherwise specified.)

Parameter	Symbol	Conditions	Min.	Typ.	Max.	Unit	
<b>AiP74HC14</b>							
nA, nB to nY propagation delay	$t_{pd}$	see Figure 5 <sup>[1]</sup>	$V_{CC}=2.0\text{V}$	-	-	155	ns
			$V_{CC}=4.5\text{V}$	-	-	31	ns
			$V_{CC}=6.0\text{V}$	-	-	26	ns
transition time	$t_t$	see Figure 5 <sup>[2]</sup>	$V_{CC}=2.0\text{V}$	-	-	95	ns
			$V_{CC}=4.5\text{V}$	-	-	19	ns
			$V_{CC}=6.0\text{V}$	-	-	15	ns
<b>AiP74HCT14</b>							
nA, nB to nY propagation delay	$t_{pd}$	see Figure 5 <sup>[1]</sup>	$V_{CC}=4.5\text{V}$	-	-	43	ns
transition time	$t_t$	see Figure 5 <sup>[2]</sup>	$V_{CC}=4.5\text{V}$	-	-	19	ns

Note:

[1]  $t_{pd}$  is the same as  $t_{PLH}$  and  $t_{PHL}$ .

[2]  $t_t$  is the same as  $t_{THL}$  and  $t_{TLH}$ .

### 3.3.6、AC Characteristics 3

( $T_{amb}=-40^{\circ}\text{C}$  to  $+85^{\circ}\text{C}$ , voltages are referenced to GND (ground=0V), unless otherwise specified.)

Parameter	Symbol	Conditions	Min.	Typ.	Max.	Unit	
<b>AiP74HC14</b>							
nA, nB to nY propagation delay	$t_{pd}$	see Figure 5 <sup>[1]</sup>	$V_{CC}=2.0\text{V}$	-	-	190	ns
			$V_{CC}=4.5\text{V}$	-	-	38	ns
			$V_{CC}=6.0\text{V}$	-	-	32	ns
transition time	$t_t$	see Figure 5 <sup>[2]</sup>	$V_{CC}=2.0\text{V}$	-	-	110	ns
			$V_{CC}=4.5\text{V}$	-	-	22	ns
			$V_{CC}=6.0\text{V}$	-	-	19	ns
<b>AiP74HCT14</b>							
nA, nB to nY propagation delay	$t_{pd}$	see Figure 5 <sup>[1]</sup>	$V_{CC}=4.5\text{V}$	-	-	51	ns
transition time	$t_t$	see Figure 5 <sup>[2]</sup>	$V_{CC}=4.5\text{V}$	-	-	22	ns

Note:

[1]  $t_{pd}$  is the same as  $t_{PLH}$  and  $t_{PHL}$ .

[2]  $t_t$  is the same as  $t_{THL}$  and  $t_{TLH}$ .



### 3.3.7、 Transfer Characteristics 1

( $T_{amb}=25^{\circ}\text{C}$ , voltages are referenced to GND (ground=0V), unless otherwise specified.)

Parameter	Symbol	Conditions	Min.	Typ.	Max.	Unit
<b>AiP74HC14</b>						
positive-going threshold voltage	$V_{T+}$	$V_{CC}=2.0\text{V}$	0.7	1.18	1.5	V
		$V_{CC}=4.5\text{V}$	1.7	2.38	3.15	V
		$V_{CC}=6.0\text{V}$	2.1	3.14	4.2	V
negative-going threshold voltage	$V_{T-}$	$V_{CC}=2.0\text{V}$	0.3	0.52	0.9	V
		$V_{CC}=4.5\text{V}$	0.9	1.4	2.0	V
		$V_{CC}=6.0\text{V}$	1.2	1.89	2.6	V
hysteresis voltage	$V_H$	$V_{CC}=2.0\text{V}$	0.2	0.66	1.0	V
		$V_{CC}=4.5\text{V}$	0.4	0.98	1.4	V
		$V_{CC}=6.0\text{V}$	0.6	1.25	1.6	V
<b>AiP74HCT14</b>						
positive-going threshold voltage	$V_{T+}$	$V_{CC}=4.5\text{V}$	1.2	1.41	1.9	V
		$V_{CC}=5.5\text{V}$	1.4	1.59	2.1	V
negative-going threshold voltage	$V_{T-}$	$V_{CC}=4.5\text{V}$	0.5	0.85	1.2	V
		$V_{CC}=5.5\text{V}$	0.6	0.99	1.4	V
hysteresis voltage	$V_H$	$V_{CC}=4.5\text{V}$	0.4	0.56	-	V
		$V_{CC}=5.5\text{V}$	0.4	0.6	-	V

### 3.3.8、 Transfer Characteristics 2

( $T_{amb}=-40^{\circ}\text{C}$  to  $+85^{\circ}\text{C}$ , voltages are referenced to GND (ground=0V), unless otherwise specified.)

Parameter	Symbol	Conditions	Min.	Typ.	Max.	Unit
<b>AiP74HC14</b>						
positive-going threshold voltage	$V_{T+}$	$V_{CC}=2.0\text{V}$	0.7	-	1.5	V
		$V_{CC}=4.5\text{V}$	1.7	-	3.15	V
		$V_{CC}=6.0\text{V}$	2.1	-	4.2	V
negative-going threshold voltage	$V_{T-}$	$V_{CC}=2.0\text{V}$	0.3	-	0.9	V
		$V_{CC}=4.5\text{V}$	0.9	-	2.0	V
		$V_{CC}=6.0\text{V}$	1.2	-	2.6	V
hysteresis voltage	$V_H$	$V_{CC}=2.0\text{V}$	0.2	-	1.0	V
		$V_{CC}=4.5\text{V}$	0.4	-	1.4	V
		$V_{CC}=6.0\text{V}$	0.6	-	1.6	V
<b>AiP74HCT14</b>						
positive-going threshold voltage	$V_{T+}$	$V_{CC}=4.5\text{V}$	1.2	-	1.9	V
		$V_{CC}=5.5\text{V}$	1.4	-	2.1	V
negative-going threshold voltage	$V_{T-}$	$V_{CC}=4.5\text{V}$	0.5	-	1.2	V
		$V_{CC}=5.5\text{V}$	0.6	-	1.4	V
hysteresis voltage	$V_H$	$V_{CC}=4.5\text{V}$	0.4	-	-	V
		$V_{CC}=5.5\text{V}$	0.4	-	-	V



### 3.3.9、 Transfer Characteristics 3

( $T_{amb}=-40^{\circ}\text{C}$  to  $+105^{\circ}\text{C}$ , voltages are referenced to GND (ground=0V), unless otherwise specified.)

Parameter	Symbol	Conditions	Min.	Typ.	Max.	Unit
<b>AiP74HC14</b>						
positive-going threshold voltage	$V_{T+}$	$V_{CC}=2.0\text{V}$	0.7	-	1.5	V
		$V_{CC}=4.5\text{V}$	1.7	-	3.15	V
		$V_{CC}=6.0\text{V}$	2.1	-	4.2	V
negative-going threshold voltage	$V_{T-}$	$V_{CC}=2.0\text{V}$	0.3	-	0.9	V
		$V_{CC}=4.5\text{V}$	0.9	-	2.0	V
		$V_{CC}=6.0\text{V}$	1.2	-	2.6	V
hysteresis voltage	$V_H$	$V_{CC}=2.0\text{V}$	0.2	-	1.0	V
		$V_{CC}=4.5\text{V}$	0.4	-	1.4	V
		$V_{CC}=6.0\text{V}$	0.6	-	1.6	V
<b>AiP74HCT14</b>						
positive-going threshold voltage	$V_{T+}$	$V_{CC}=4.5\text{V}$	1.2	-	1.9	V
		$V_{CC}=5.5\text{V}$	1.4	-	2.1	V
negative-going threshold voltage	$V_{T-}$	$V_{CC}=4.5\text{V}$	0.5	-	1.2	V
		$V_{CC}=5.5\text{V}$	0.6	-	1.4	V
hysteresis voltage	$V_H$	$V_{CC}=4.5\text{V}$	0.4	-	-	V
		$V_{CC}=5.5\text{V}$	0.4	-	-	V

## 4、 Testing Circuit

### 4.1、 AC Testing Circuit

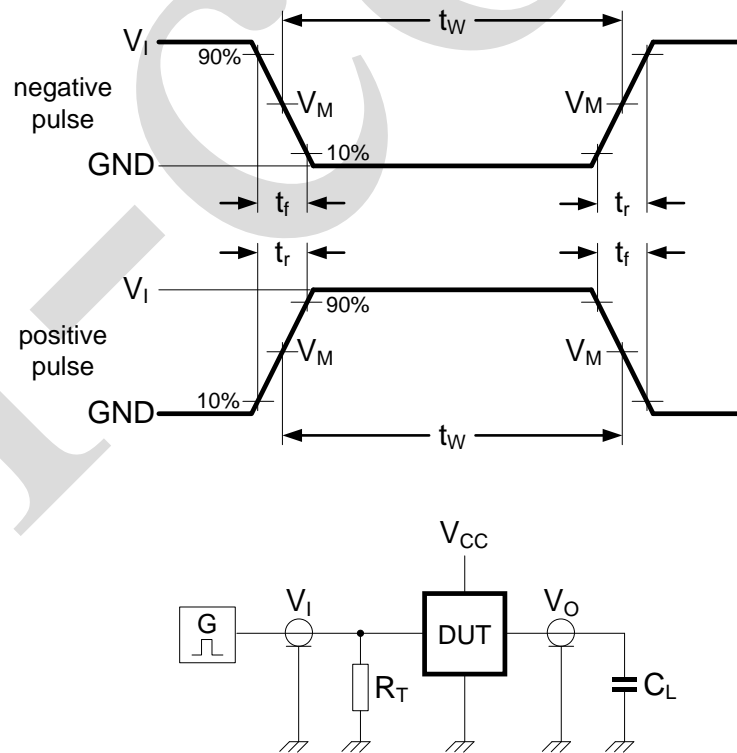

Figure 4. Test circuit for measuring switching times



Definitions for test circuit:

$C_L$ =load capacitance including jig and probe capacitance.

$R_T$ =termination resistance should be equal to the output impedance  $Z_o$  of the pulse generator.

## 4.2、 AC Testing Waveforms

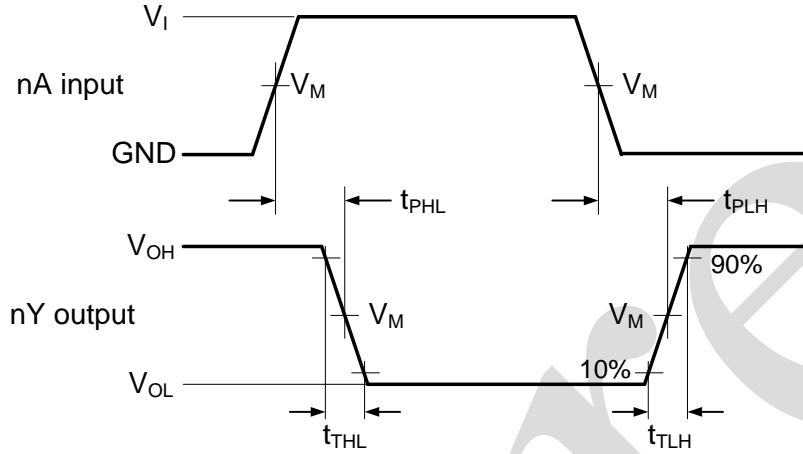

Figure 5. Input to output propagation delays

## 4.3、 Transfer Characteristics Waveforms

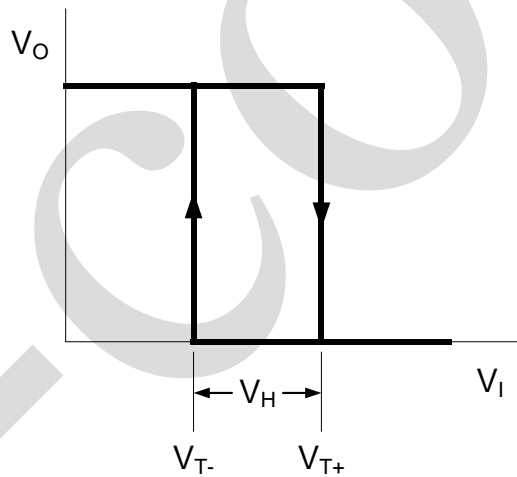

Figure 6. Transfer characteristics

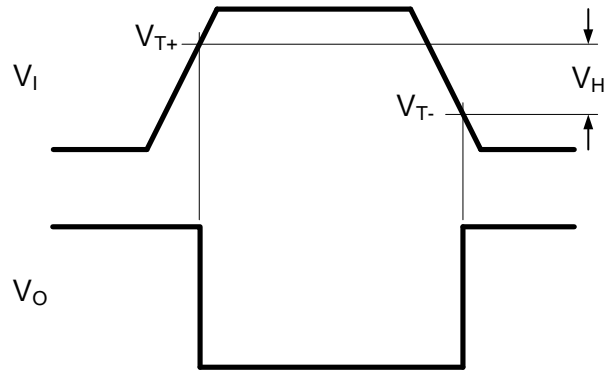

Figure 7. Transfer characteristics definitions

#### 4.4、 Measurement Points

Type	Input	Output		
	$V_M$	$V_M$	$V_X$	$V_Y$
AiP74HC14	$0.5 \times V_{CC}$	$0.5 \times V_{CC}$	$0.1 \times V_{CC}$	$0.9 \times V_{CC}$
AiP74HCT14	1.3V	1.3V	$0.1 \times V_{CC}$	$0.9 \times V_{CC}$

#### 4.5、 Test Data

Type	Input		Load	Test
	$V_I$	$t_r, t_f$	$C_L$	
AiP74HC14	$V_{CC}$	6.0ns	15pF, 50pF	$t_{PLH}, t_{PHL}$
AiP74HCT14	3.0V	6.0ns	15pF, 50pF	$t_{PLH}, t_{PHL}$





## 5、Package Information

### 5.1、DIP14

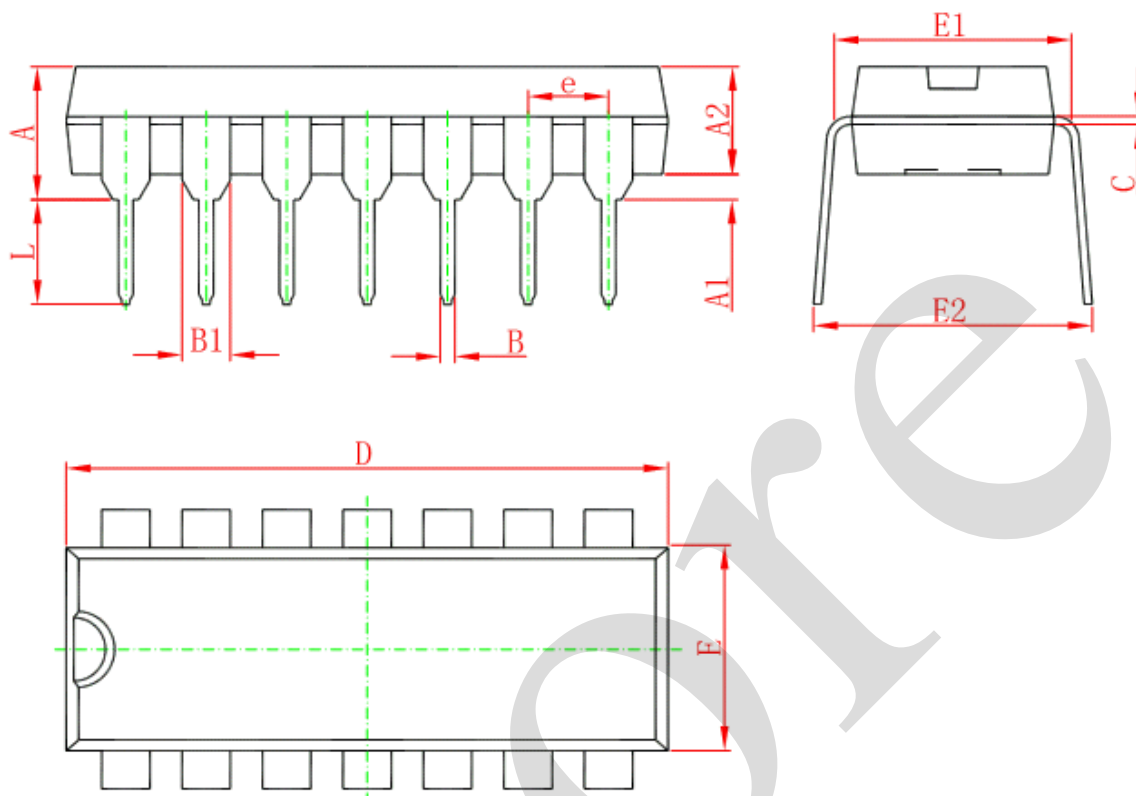

Symbol	Dimensions In Millimeters		Dimensions In Inches	
	Min	Max	Min	Max
A	3.710	4.310	0.146	0.170
A1	0.510		0.020	
A2	3.200	3.600	0.126	0.142
B	0.380	0.570	0.015	0.022
B1	1.524 (BSC)		0.060 (BSC)	
C	0.204	0.360	0.008	0.014
D	18.800	19.200	0.740	0.756
E	6.200	6.600	0.244	0.260
E1	7.320	7.920	0.288	0.312
e	2.540 (BSC)		0.100 (BSC)	
L	3.000	3.600	0.118	0.142
E2	8.400	9.000	0.331	0.354



5.2、SOP14

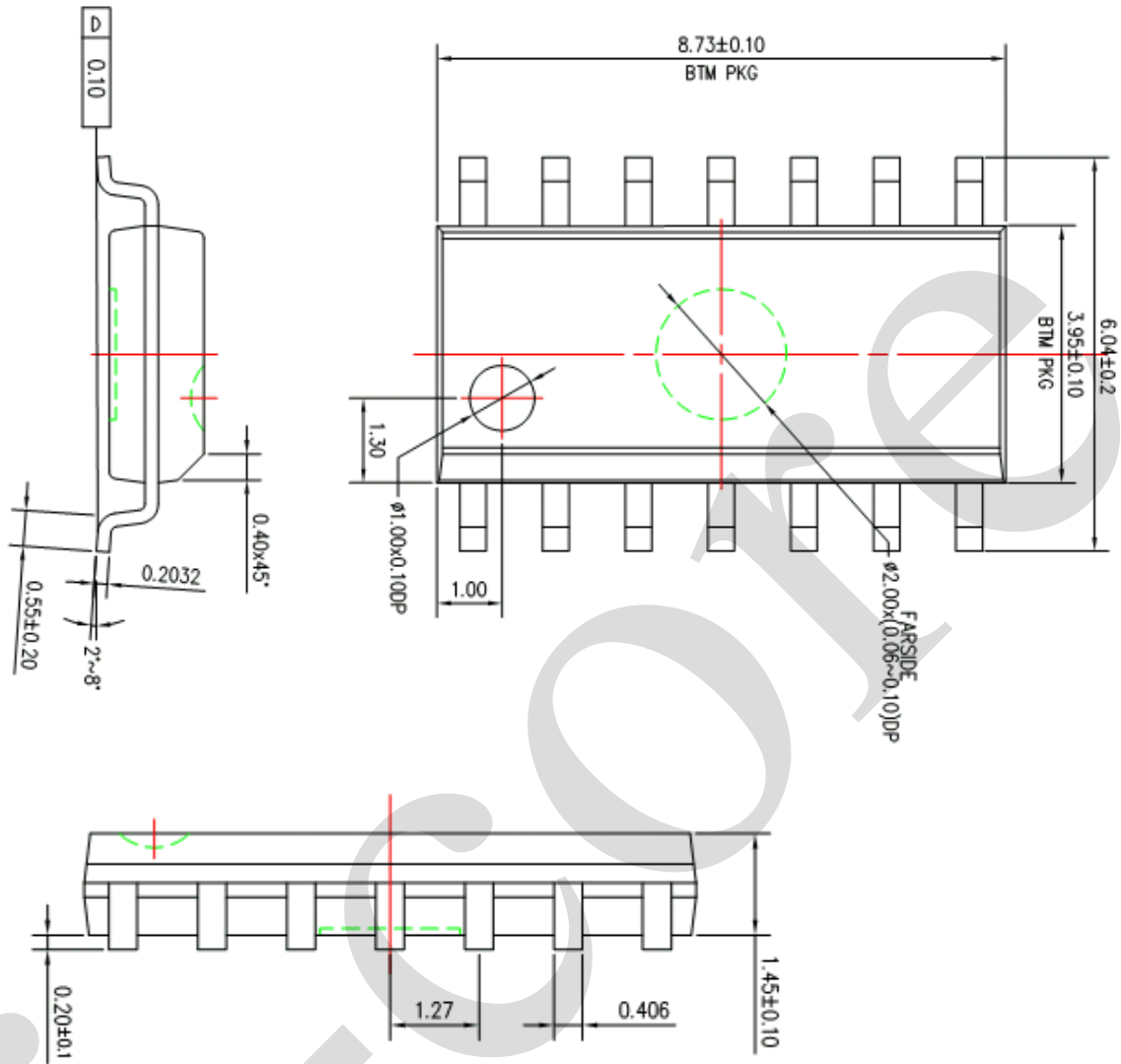



## 5.3、TSSOP14

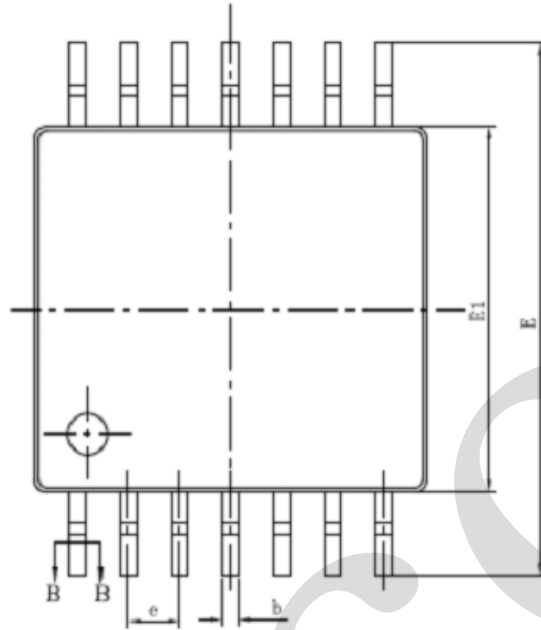
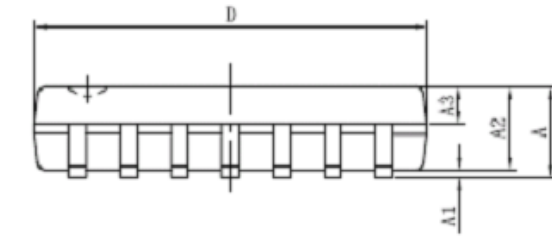

SYMBOL	MILLIMETER	
	MIN	MAX
A	—	1.20
A1	0.05	0.15
A2	0.90	1.05
A3	0.39	0.49
b	0.20	0.30
b1	0.19	0.25
c	0.13	0.19
c1	0.12	0.14
D	4.86	5.06
E1	4.30	4.50
E	6.20	6.60
e	0.65BSC	
L	0.45	0.75
L1	1.00BSC	
$\theta$	0	8°

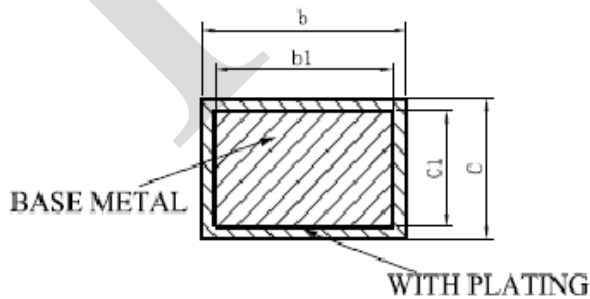
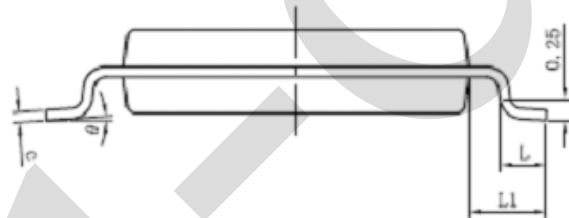

SECTION B-B



## 6、 Statements And Notes

### 6.1、 The name and content of Hazardous substances or Elements in the product

Part name	Hazardous substances or Elements									
	Lead and lead compounds	Mercury and mercury compounds	Cadmium and cadmium compounds	Hexavalent chromium compounds	Polybrominated biphenyls	Polybrominated biphenyl ethers	Dibutyl phthalate	Butylbenzyl phthalate	Di-2-ethylhexyl phthalate	Diisobutyl phthalate
Lead frame	○	○	○	○	○	○	○	○	○	○
Plastic resin	○	○	○	○	○	○	○	○	○	○
Chip	○	○	○	○	○	○	○	○	○	○
The lead	○	○	○	○	○	○	○	○	○	○
Plastic sheet installed	○	○	○	○	○	○	○	○	○	○
explanation	○: Indicates that the content of hazardous substances or elements in the detection limit of the following the SJ/T11363-2006 standard. ×: Indicates that the content of hazardous substances or elements exceeding the SJ/T11363-2006 Standard limit requirements.									

### 6.2、 Notion

Recommended carefully reading this information before the use of this product;

The information in this document are subject to change without notice;

This information is using to the reference only, the company is not responsible for any loss;

The company is not responsible for the any infringement of the third party patents or other rights of the responsibility.