

ZX-QC-LT61372516

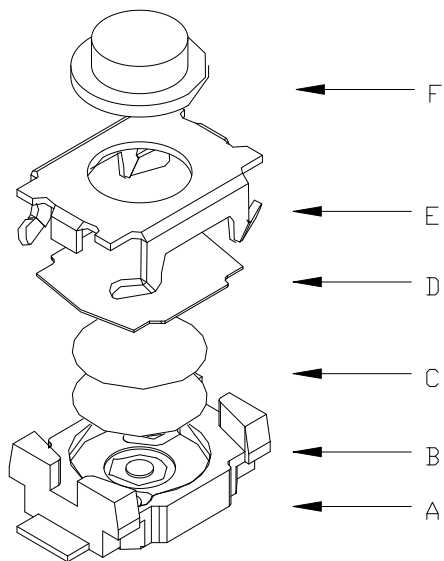

F
E
D
C
B
A

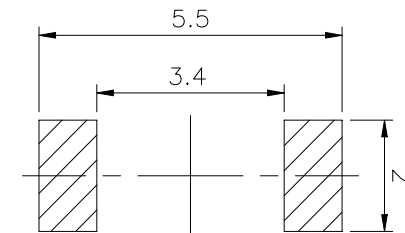
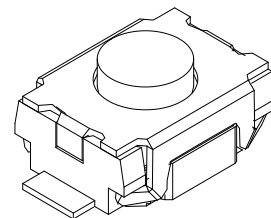
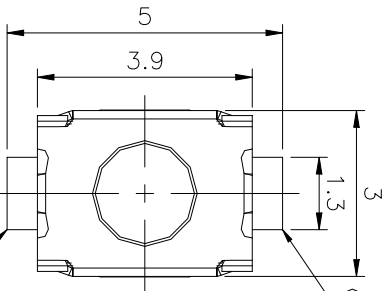
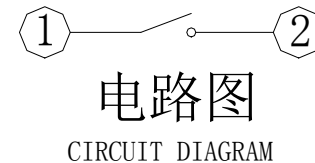
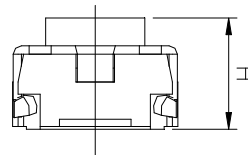
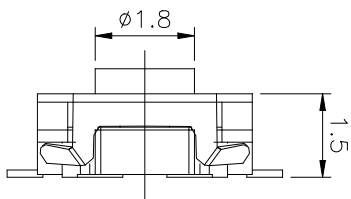

PCB. 焊接图
PCB. WELDING DRAWING

主要技术参数、性能

The Main Thchnology Performance

额定电流、电压 Rate voltage.current	50mA DC12V
接触电阻 Contact resistance	≤100mΩ
按力 Operating force	±50gf
行程 Travel	0.20±0.10mm
绝缘电阻 Insulated resistance	≥100MΩ
介电强度 Dielectric strength	≥250VAC/1min

F	按钮	LCP	1	黑色
E	盖板	不锈钢	1	清洗
D	防尘胶	聚酰亚胺	1	橙黄色
C	弹片	不锈钢	2	镀银
B	本体	LCP	1	黑色
A	卡件	磷铜	1	镀银
项目 ITEM	名称 DESCRIPTION	材质 MATERIAL	数量 QTY	表面处理/颜色 FINSH/COLOR

						第一视角 FIRST VIEW		名称/NAME:	
								3.9*2.93*2.5mm 立贴 轻触开关	
						比例 SCALE		型号/MODEL:	
						1:1		ZX-QC-LT61372516	
标记 SING	处数 FREQUENCY	更改文件号 REVISION	签名 APPROVED	日期 DATE	单位 UNIT	一般公差 GENERAL TOLERANCE		兆星精密电子(深圳)有限公司	
设计 DESIGN					mm	≥0~2<	±0.15		
审核 CHECKED					重量 WEIGHT	≥2~5<	±0.25		
批准 APPROVED						≥5	±0.35		
						角度 ANGLE	±0.5°		