

REV.	DESCRIPTION	APPD	DATE
△/1	外壳弹片改直	Lin R	23/05/21
△/2	尺寸0.70改为0.55	Lin L	23/05/21
△/3	尺寸3.50改为2.30	Lin R	23/05/21
△/4	主体底部增加孔位	Lin L	23/05/21
△/5	增加CD PIN 高低管控	Lin R	23/05/21

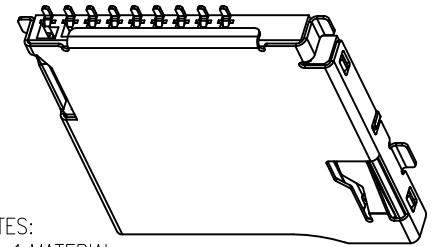

NOTES:
 1.MATERIAL:
 HOUSING: HIGH TEMPERATURE THERMOPLASTIC
 UL94V_0,COLOR:BLACK.
 CONTACT: COPPER ALLOYS.
 COVER: COPPER ALLOYS OR STEEL.
 2.PLATING:
 UNDERPLATE: NICKEL.
 CONTACT AREA: GOLD OVER NICKEL.
 SOLDER AREA: TIN OVER NICKEL.
 3.MULTIMEDIA CARD COMPATIBLE

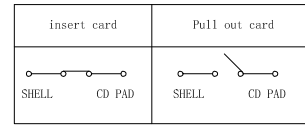

PIN NO.	NAME	YTYPE	DESCRIPTION
1	DAT2	I/O/PP	DATE LINE(BIT2)
2	CD/DAT3	I/O/PP	CARD DETECT DATE LIN(BIT3)
3	CMD	PP	COMMAND RESPONSE
4	VDD	S	SUPPLY VOLTAGE
5	CLX	I	CLOCK
6	VSS	S	SUPPLY VOLTAGE GROUND
7	DAT0	I/O/PP	DATE LINE(BIT0)
8	DAT1	I/O/PP	DATE LINE(DIT1)
9	CD	CD	CD

RECOMMENDED P.C.B HOLE LAYOUT
 COMPONENT SIDE VIEW(TOLERANCE: +/-0.05)

PART NO: ZX-TF-281.8X		MATERIAL:		 兆星精密电子 (深圳) 有限公司	
LOT NO:		FINSH:			
UNIT: MM	SIZE: A4	COLOR:		TITLE: MicroSD卡(TF卡) 卡座 9P	
TOLERANCES: X.X=±0.35 X.XX=±0.25 X.XXX=±0.15		GENERAL ANGLE: X.X=±3.0° X.XX=±2.0°		DR: Lin L	DWG NO:
APP:		CHK:	SCALE: 1:1	SHEET: 1 OF 3	REV: E

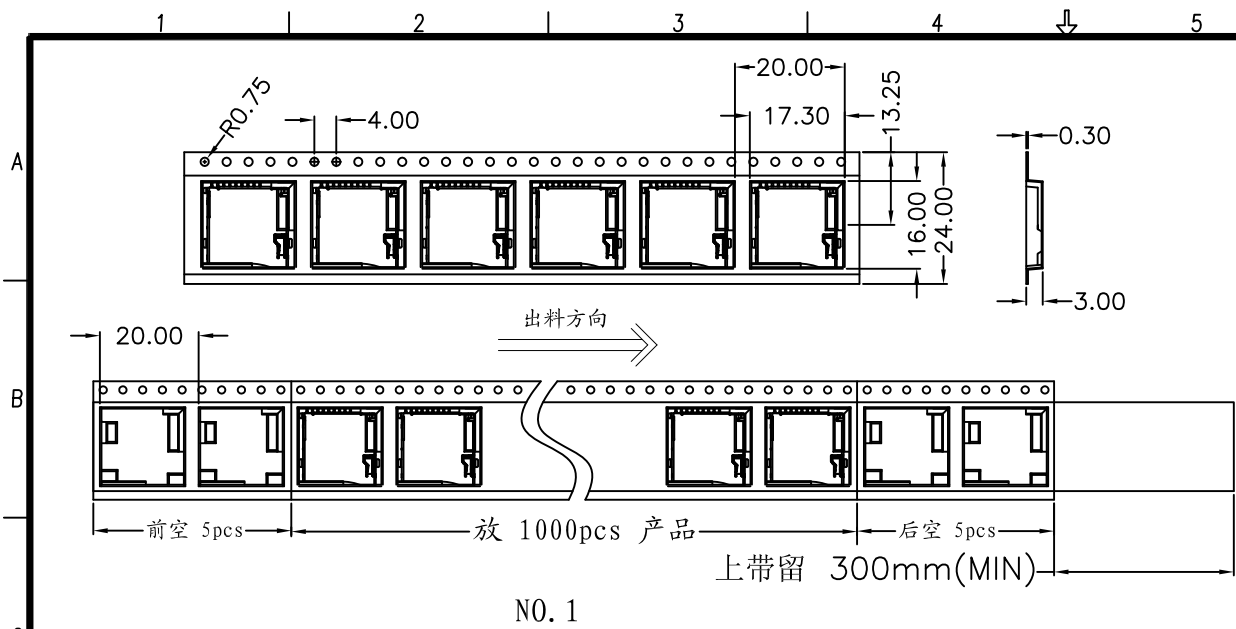

NO. 1

REV.	DESCRIPTION	APPD	DATE

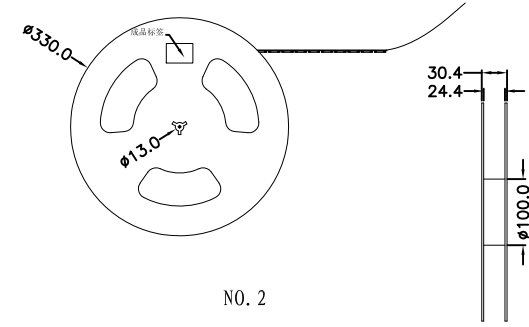

NO. 2

1. 材质要求:
- 1.1 纸箱的材质为K-K; 外形尺寸为34*34*38.5;
 - 1.2 卷盘的材质为PS, 卷盘的外形尺寸为 $\phi 330 \times 30.4$;
 - 1.3 卷带的材质为PS, 卷带的外形尺寸为20200*24.00*3.0mm;
2. 包装方式:
- 2.1 将卷带放入包装机后, 前空5PCS, 后放产品1000PCS, 再后空5PCS; 上带留300MM长度。
 - 2.2 将包装好的产品从包装机上取下并包装好, 贴上内盘标签;
 - 2.3 把累叠好的12盘叠放入纸箱中共计12Kset, 上下放纸板, 纸箱四个角塞护角纸;
 - 2.4 把包装好的成品打包封箱, 并在纸箱外贴上标签

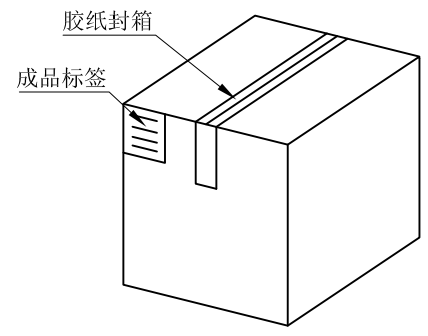

纸箱规格: 340*340*385

NO. 4

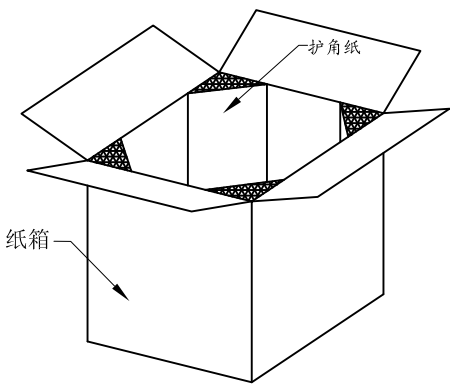
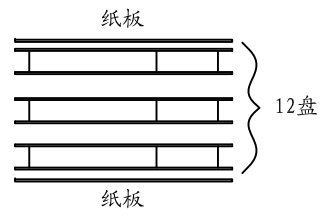

NO. 3

PART NO: ZX-TF-281.8X		MATERIAL:		 兆星精密电子 (深圳) 有限公司	
LOT NO:		FINSH:			
UNIT: MM	SIZE: A4	COLOR:		TITLE: Mi croSD卡 (TF卡) 卡座 9P	
TOLERANCES: X.X=±0.35 X.XX=±0.25 X.XXX=±0.15		GENERAL ANGLE: X.X=±3.0° X.XX=±2.0°		DR: Lin L	DWG NO:
		CHK:		APP:	REVISION: B/3
		SCALE: 1:1		SHEET: 3 OF 3	