

SCHOTTKY BARRIER RECTIFIERS

FEATURES

- Metal silicon junction, majority carrier conduction
- Guarding for overvoltage protection
- Low power loss, high efficiency
- High current capability
- low forward voltage drop
- High surge capability
- For use in low voltage, high frequency inverters, free wheeling, and polarity protection applications

PINNING

PIN	DESCRIPTION
1	Cathode
2	Anode

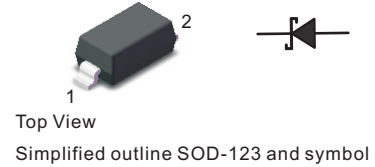

MECHANICAL DATA

- Case: SOD-123
- Terminals: Solderable per MIL-STD-750, Method 2026
- Approx. Weight: 16mg/0.00056oz

Maximum Ratings and Electrical characteristics

Ratings at 25 °C ambient temperature unless otherwise specified.

Parameter	Symbols	1N5819W SL	Units
Maximum Repetitive Peak Reverse Voltage	V_{RRM}	40	V
Maximum RMS voltage	V_{RMS}	28	V
Maximum DC Blocking Voltage	V_{DC}	40	V
Maximum Average Forward Rectified Current	$I_{F(AV)}$	1	A
Peak Forward Surge Current, 8.3ms Single Half Sine-wave Superimposed On Rated Load (JEDEC method)	I_{FSM}	25	A
Maximum Instantaneous Forward Voltage at 1 A at 3 A	V_F	0.6 0.9	V
Maximum Instantaneous Reverse Current at $T_A = 25^\circ\text{C}$ Rated DC Reverse Voltage $T_A = 100^\circ\text{C}$	I_R	1 10	mA
Typical Junction Capacitance	C_j	110	pF
Storage and Operating Junction Temperature Range	T_j, T_{stg}	-55 ~ +125	°C

Fig.1 Forward Current Derating Curve

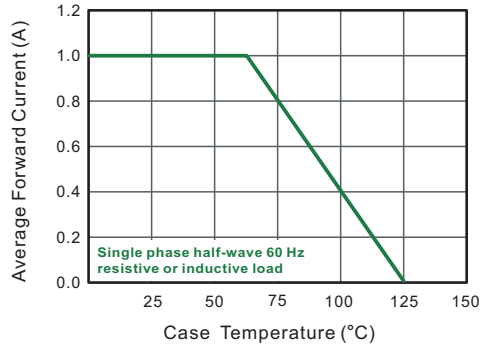

Fig.2 Typical Reverse Characteristics

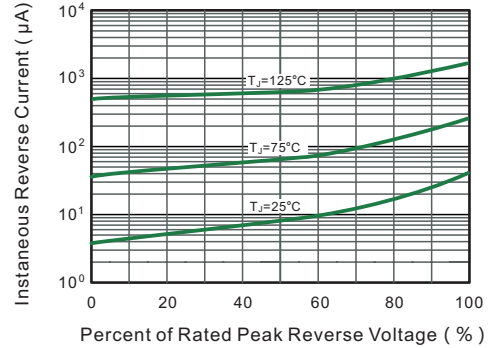

Fig.3 Typical Forward Characteristic

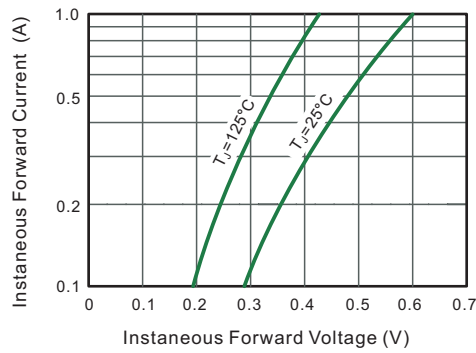

Fig.4 Typical Junction Capacitance

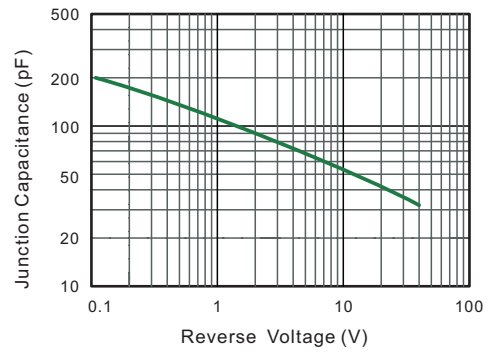
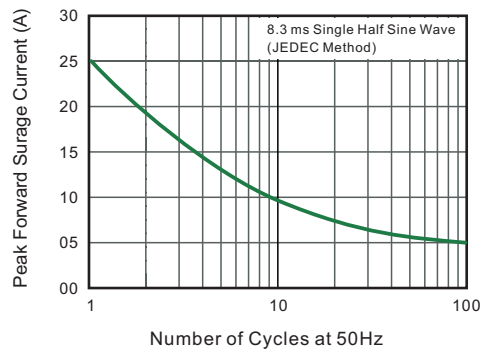

Fig.5 Maximum Non-Repetitive Peak Forward Surge Current



PACKAGE OUTLINE

Plastic surface mounted package; 2 leads

SOD-123

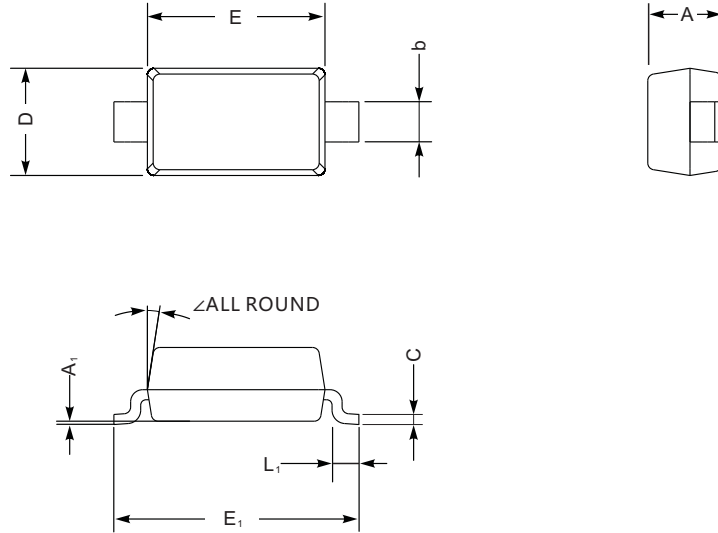

SOD-123 mechanical data

UNIT		A	C	D	E	E ₁	L ₁	b	A ₁	∠
mm	max	1.3	0.22	1.8	2.8	3.9	0.45	0.7	0.2	9°
	min	0.9	0.09	1.5	2.5	3.6	0.25	0.5	—	
mil	max	51	8.7	71	110	154	18	28	8	
	min	35	3.5	59	98	142	10	20	—	

The recommended mounting pad size

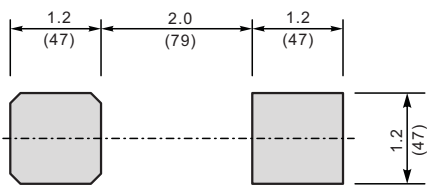

Unit: $\frac{\text{mm}}{\text{(mil)}}$