

Pin	A	B	C
2	1.25	5.75	3.75
3	2.50	7.00	5.00
4	3.75	8.25	6.25
5	5.00	9.50	7.50
6	6.25	10.75	8.75
7	7.50	12.00	10.00
8	8.75	13.25	11.25
9	10.00	14.50	12.50
10	11.25	15.75	13.75
11	12.50	17.00	15.00
12	13.75	18.25	16.25
13	15.00	19.50	17.50
14	16.25	20.75	18.75
15	17.50	22.00	20.00
16	18.75	23.25	21.25

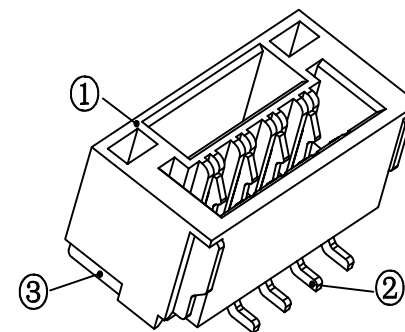

技术参数

间距: 1.25
 温度范围: -25~+85°C
 额定电压: 125V AC, DC
 额定电流: 1.0A AC, DC
 接触电阻: 20mΩ
 绝缘电阻: 100MΩ
 耐压: 500V AC/minute

线性公差 / General Tolerance	
X	±0.2
X.X	±0.1
X.XX	±0.05
角度公差 / Angle Tolerance	
X°	±5.0°
X.X°	±3.0°
X.XX°	±1.0°

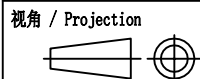

标记	变更内容	签名	年月日
绘图	Lin L 230509		
审核	Lin R 230509		
工艺		批准	Lin R 230509

材料 / Material

- ①塑座: LCP 本色
- ②接触针: 磷铜 (镀锡)
- ③焊片: 磷铜 (镀锡)

单位 (Units)	版本	比例
mm	2.0	1:1
共 1 张		第 1 张

兆星精密电子 (深圳) 有限公司

品名 / ProduceName

GH1.25 立贴 8P

型号 / Model

ZX-BX-GH1.25-LT8P